

TLVx316-Q1

10MHz、轨到轨输入/输出、低电压、1.8V CMOS 运算放大器

1 特性

- 符合汽车应用 要求
- 具有符合 AEC-Q100 标准的下列结果：
 - 器件温度 1 级：-40°C 至 +125°C 的环境运行温度范围
 - 器件人体放电模型 (HBM) 静电放电 (ESD) 分类等级 3A
 - 带电器件模型 (CDM) ESD 分类等级 C5
- 单位增益带宽：10MHz
- 低 I_Q ：每通道 400 μ A
 - 出色的功率带宽比
 - 在温度和电源电压范围内保持稳定的 I_Q
- 宽电源电压范围：1.8V 至 5.5V
- 低噪声：1kHz 时为 12nV/ $\sqrt{\text{Hz}}$
- 低输入偏置电流： ± 10 pA
- 偏移电压： ± 0.75 mV
- 单位增益稳定
- 内部射频干扰 (RFI) 和电磁干扰 (EMI) 滤波器
- 通道数量：
 - TLV316-Q1：1
 - TLV2316-Q1：2
 - TLV4316-Q1：4
- 扩展温度范围：-40°C 至 +125°C

2 应用

- 汽车 应用：
 - 高级驾驶员辅助系统 (ADAS)
 - 车身电子装置和照明
 - 电流感测
 - 电池管理系统

单极低通滤波器

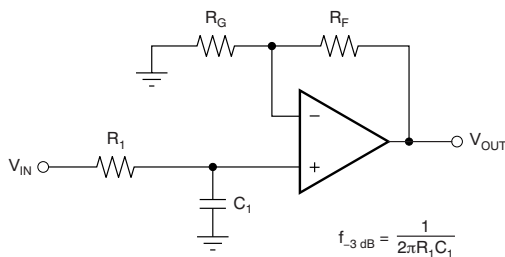

$$\frac{V_{\text{OUT}}}{V_{\text{IN}}} = \left(1 + \frac{R_F}{R_G}\right) \left(\frac{1}{1 + sR_1 C_1}\right)$$

3 说明

TLV316-Q1（单路）、TLV2316-Q1（双路）和 TLV4316-Q1（四路）器件构成了低功耗通用运算放大器系列。该器件系列将轨至轨输入和输出摆幅、低静态电流（每通道的典型值为 400 μ A）等特性与 10MHz 的较宽带宽和超低噪声（1kHz 时为 12nV/ $\sqrt{\text{Hz}}$ ）相结合，因此适用于要求兼具快速特性与良好功率比的电路。低输入偏置电流支持在源阻抗高达兆欧级的应用。TLVx316-Q1 的低输入偏置电流产生的电流噪声极低，该器件系列因此备受高阻抗传感器接口的青睐。

TLVx316-Q1 采用稳健耐用的设计，方便电路设计人员使用。该器件具有单位增益稳定的集成 RFI 和 EMI 抑制滤波器，在过驱条件下不会出现反相，并且具有高静电放电 (ESD) 保护 (4kV HBM)。

此类器件经过优化，适合在 1.8V (± 0.9 V) 至 5.5V (± 2.75 V) 的低电压状态下工作。产品组合中最新补充的这款低压 CMOS 运算放大器与 TLVx313-Q1 和 TLVx314-Q1 系列相结合，为用户提供了广泛的带宽、噪声和功率选项，可以满足各种应用的需求提供了灵活性和便利性。

中的 SC70 (5)、SOIC (8) 和 SOIC (14) 封装
器件信息⁽¹⁾

器件型号	封装	封装尺寸 (标称值)
TLV316-Q1	SOT-23 (5)	1.60mm x 2.90mm
TLV2316-Q1	VSSOP (8)	3.00mm x 3.00mm
TLV4316-Q1	TSSOP (14)	4.40mm x 5.00mm

(1) 如需了解所有可用封装，请参阅产品说明书末尾的可订购产品附录。

10MHz 带宽下的低电源电流 (400 μ A/通道)

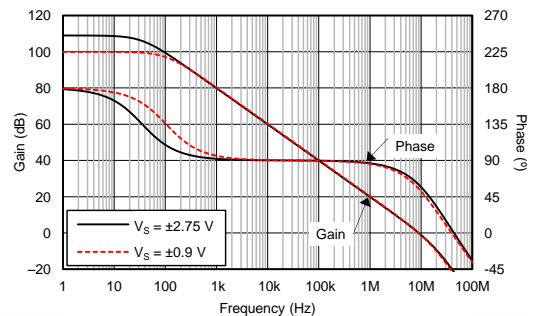

目录

1	特性	1	8.3	Feature Description	15
2	应用	1	8.4	Device Functional Modes	16
3	说明	1	9	Application and Implementation	17
4	修订历史记录	2	9.1	Application Information	17
5	Device Comparison Table	3	9.2	System Examples	17
6	Pin Configuration and Functions	4	10	Power Supply Recommendations	18
7	Specifications	7	10.1	Input and ESD Protection	18
7.1	Absolute Maximum Ratings	7	11	Layout	19
7.2	ESD Ratings	7	11.1	Layout Guidelines	19
7.3	Recommended Operating Conditions	7	11.2	Layout Example	19
7.4	Thermal Information: TLV316-Q1	8	12	器件和文档支持	20
7.5	Thermal Information: TLV2316-Q1	8	12.1	文档支持	20
7.6	Thermal Information: TLV4316-Q1	8	12.2	相关链接	20
7.7	Electrical Characteristics	9	12.3	社区资源	20
7.8	Typical Characteristics: Table of Graphs	10	12.4	商标	20
7.9	Typical Characteristics	11	12.5	静电放电警告	21
8	Detailed Description	14	12.6	Glossary	21
8.1	Overview	14	13	机械、封装和可订购信息	21
8.2	Functional Block Diagram	14			

4 修订历史记录

Changes from Revision A (December 2016) to Revision B	Page
• 更正了输入错误；在 <i>特性</i> 部分中将部件号从 TLV314、TLV2314 和 TLV4314 更改为 TLV316-Q1、TLV2316-Q1 和 TLV4316-Q1	1
• Changed values in the <i>Thermal Information: TLV4316-Q1</i> table to align with JEDEC standards	8

Changes from Original (November 2016) to Revision A	Page
• 已更改 CDM ESD 分类等级 C6 至 C5（位于 <i>特性</i> 部分）	1
• 已删除 <i>器件信息表</i>	1
• Deleted the DCK (SC70) package from the TLV316-Q1 pinout diagram in the <i>Pin Configurations and Functions</i> section	4
• Deleted the DCK (SC70) pinout information from the <i>Pin Functions: TLV316-Q1</i> table in the <i>Pin Configurations and Functions</i> section	4
• Deleted D (SOIC) package from the TLV2316-Q1 pinout diagram in the <i>Pin Configurations and Functions</i> section	5
• Deleted the D (SOIC) package from TLV4316-Q1 pinout diagram in the <i>Pin Configurations and Functions</i> section	6
• Changed the <i>ESD Ratings</i> table from commercial to automotive specifications	7
• Changed the CDM ESD rating from ± 1500 to ± 750 in the <i>ESD Ratings</i> table	7
• Deleted the DCK (SC70) package from the <i>Thermal Information: TLV316-Q1</i> table in the <i>Specifications</i> section	8
• Changed the formatting of all <i>Thermal Information</i> table notes	8
• Deleted the D (SOIC) package from the <i>Thermal Information: TLV2316-Q1</i> table in the <i>Specifications</i> section	8
• Deleted the D (SOIC) package from the <i>Thermal Information: TLV4316-Q1</i> table in the <i>Specifications</i> section	8
• 已删除 the static literature number in the SBOA128 application note reference in the <i>EMI Susceptibility and Input Filtering</i> section	16
• 已删除 the static literature number in document reference in the <i>Layout Guidelines</i> section	19
• 已更改 the layout example image (Figure 41) in <i>Layout Example</i> section	19
• 已删除 <i>相关文档部分</i>	20

5 Device Comparison Table

DEVICE	NO. OF CHANNELS	PACKAGE-LEADS				
		DBV	DCK	D	DGK	PW
TLV316-Q1	1	5	5	—	—	—
TLV2316-Q1	2	—	—	8	8	—
TLV4316-Q1	4	—	—	14	—	14

6 Pin Configuration and Functions

**TLV316-Q1 DBV Package
5-Pin SOT-23
Top View**

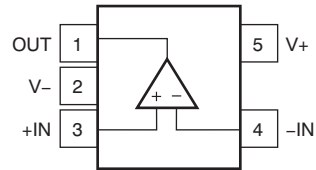

Pin Functions: TLV316-Q1

PIN		I/O	DESCRIPTION
NAME	NO.		
-IN	4	I	Inverting input
+IN	3	I	Noninverting input
OUT	1	O	Output
V-	2	—	Negative (lowest) supply or ground (for single-supply operation)
V+	5	—	Positive (highest) supply

**TLV2316-Q1 DGK Package
8-Pin VSSOP
Top View**

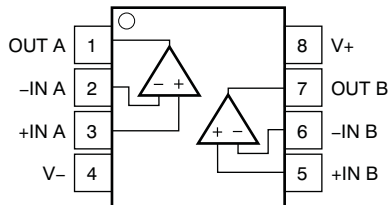

Pin Functions: TLV2316 -Q1

PIN		I/O	DESCRIPTION
NAME	NO.		
-IN A	2	I	Inverting input, channel A
+IN A	3	I	Noninverting input, channel A
-IN B	6	I	Inverting input, channel B
+IN B	5	I	Noninverting input, channel B
OUT A	1	O	Output, channel A
OUT B	7	O	Output, channel B
V-	4	—	Negative (lowest) supply or ground (for single-supply operation)
V+	8	—	Positive (highest) supply

**TLV4316-Q1 PW Package
14-Pin TSSOP
Top View**

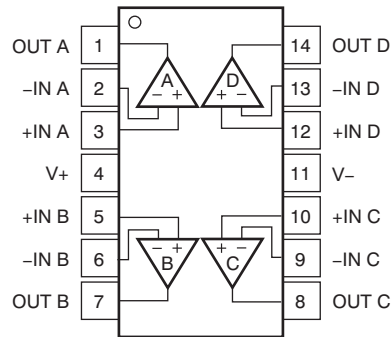

Pin Functions: TLV4316-Q1

PIN		I/O	DESCRIPTION
NAME	NO.		
-IN A	2	I	Inverting input, channel A
+IN A	3	I	Noninverting input, channel A
-IN B	6	I	Inverting input, channel B
+IN B	5	I	Noninverting input, channel B
-IN C	9	I	Inverting input, channel C
+IN C	10	I	Noninverting input, channel C
-IN D	13	I	Inverting input, channel D
+IN D	12	I	Noninverting input, channel D
OUT A	1	O	Output, channel A
OUT B	7	O	Output, channel B
OUT C	8	O	Output, channel C
OUT D	14	O	Output, channel D
V-	11	—	Negative (lowest) supply or ground (for single-supply operation)
V+	4	—	Positive (highest) supply

7 Specifications

7.1 Absolute Maximum Ratings

over operating free-air temperature (unless otherwise noted)⁽¹⁾

			MIN	MAX	UNIT
Supply voltage			7		V
Signal input pins	Voltage ⁽²⁾	Common-mode	(V ₋) - 0.5	(V ₊) + 0.5	V
		Differential	(V ₊) - (V ₋) + 0.2		
	Current ⁽²⁾		-10	10	mA
Output short-circuit ⁽³⁾			Continuous		mA
Temperature	Specified, T _A		-40	125	°C
	Junction, T _J		150		
	Storage, T _{stg}		-65	150	

- (1) Stresses beyond those listed under *Absolute Maximum Ratings* may cause permanent damage to the device. These are stress ratings only, and functional operation of the device at these or any other conditions beyond those indicated under *Recommended Operating Conditions* is not implied. Exposure to absolute-maximum-rated conditions for extended periods may affect device reliability.
- (2) Input pins are diode-clamped to the power-supply rails. Current limit input signals that can swing more than 0.5 V beyond the supply rails to 10 mA or less.
- (3) Short-circuit to ground, one amplifier per package.

7.2 ESD Ratings

			VALUE	UNIT
V _(ESD)	Electrostatic discharge	Human-body model (HBM), per AEC Q100-002 ⁽¹⁾	±4000	V
		Charged-device model (CDM), per AEC Q100-011	±750	

- (1) AEC Q100-002 indicates that HBM stressing shall be in accordance with the ANSI/ESDA/JEDEC JS-001 specification.

7.3 Recommended Operating Conditions

over operating free-air temperature range (unless otherwise noted)

		MIN	NOM	MAX	UNIT
V _S	Supply voltage	1.8		5.5	V
	Specified temperature range	-40		125	°C

7.4 Thermal Information: TLV316-Q1

THERMAL METRIC ⁽¹⁾		TLV316-Q1	
		DBV (SOT-23)	
		5 PINS	
			UNIT
$R_{\theta JA}$	Junction-to-ambient thermal resistance	221.7	°C/W
$R_{\theta JC(top)}$	Junction-to-case(top) thermal resistance	144.7	°C/W
$R_{\theta JB}$	Junction-to-board thermal resistance	49.7	°C/W
Ψ_{JT}	Junction-to-top characterization parameter	26.1	°C/W
Ψ_{JB}	Junction-to-board characterization parameter	49.0	°C/W
$R_{\theta JC(bot)}$	Junction-to-case(bottom) thermal resistance	N/A	°C/W

(1) For more information about traditional and new thermal metrics, see the [Semiconductor and IC Package Thermal Metrics](#) application report.

7.5 Thermal Information: TLV2316-Q1

THERMAL METRIC ⁽¹⁾		TLV2316-Q1	
		DGK (VSSOP)	
		8 PINS	
			UNIT
$R_{\theta JA}$	Junction-to-ambient thermal resistance	186.6	°C/W
$R_{\theta JC(top)}$	Junction-to-case(top) thermal resistance	78.8	°C/W
$R_{\theta JB}$	Junction-to-board thermal resistance	107.9	°C/W
Ψ_{JT}	Junction-to-top characterization parameter	15.5	°C/W
Ψ_{JB}	Junction-to-board characterization parameter	106.3	°C/W
$R_{\theta JC(bot)}$	Junction-to-case(bottom) thermal resistance	N/A	°C/W

(1) For more information about traditional and new thermal metrics, see the [Semiconductor and IC Package Thermal Metrics](#) application report.

7.6 Thermal Information: TLV4316-Q1

THERMAL METRIC ⁽¹⁾		TLV4316-Q1	
		PW (TSSOP)	
		14 PINS	
			UNIT
$R_{\theta JA}$	Junction-to-ambient thermal resistance	117.8	°C/W
$R_{\theta JC(top)}$	Junction-to-case(top) thermal resistance	46.5	°C/W
$R_{\theta JB}$	Junction-to-board thermal resistance	59.6	°C/W
Ψ_{JT}	Junction-to-top characterization parameter	5.3	°C/W
Ψ_{JB}	Junction-to-board characterization parameter	59	°C/W
$R_{\theta JC(bot)}$	Junction-to-case(bottom) thermal resistance	N/A	°C/W

(1) For more information about traditional and new thermal metrics, see the [Semiconductor and IC Package Thermal Metrics](#) application report.

7.7 Electrical Characteristics

at $T_A = 25^\circ\text{C}$, $R_L = 10\text{ k}\Omega$ connected to $V_S / 2$, $V_{CM} = V_S / 2$, and $V_{OUT} = V_S / 2$ (unless otherwise noted); V_S (total supply voltage) = $(V+) - (V-) = 1.8\text{ V to }5.5\text{ V}$

PARAMETER		TEST CONDITIONS	MIN	TYP	MAX	UNIT
OFFSET VOLTAGE						
V_{OS}	Input offset voltage	$V_S = 5\text{ V}$		± 0.75	± 3	mV
		$V_S = 5\text{ V}$, $T_A = -40^\circ\text{C to }125^\circ\text{C}$			± 4.5	
dV_{OS}/dT	Drift	$V_S = 5\text{ V}$, $T_A = -40^\circ\text{C to }125^\circ\text{C}$		± 2		$\mu\text{V}/^\circ\text{C}$
PSRR	Power-supply rejection ratio	$V_S = 1.8\text{ V} - 5.5\text{ V}$, $V_{CM} = (V-)$		± 30	± 175	$\mu\text{V}/\text{V}$
	Channel separation, dc	At dc		100		dB
INPUT VOLTAGE RANGE						
V_{CM}	Common-mode voltage range	$V_S = 5.5\text{ V}$	$(V-) - 0.2$		$(V+) + 0.2$	V
CMRR	Common-mode rejection ratio	$V_S = 5.5\text{ V}$, $(V-) - 0.2\text{ V} < V_{CM} < (V+) - 1.4\text{ V}$, $T_A = -40^\circ\text{C to }125^\circ\text{C}$	72	90		dB
		$V_S = 5.5\text{ V}$, $V_{CM} = -0.2\text{ V to }5.7\text{ V}$, $T_A = -40^\circ\text{C to }125^\circ\text{C}$		75		
INPUT BIAS CURRENT						
I_B	Input bias current			± 10		pA
I_{OS}	Input offset current			± 10		pA
NOISE						
E_n	Input voltage noise (peak-to-peak)	$V_S = 5\text{ V}$, $f = 0.1\text{ Hz to }10\text{ Hz}$		5		μV_{PP}
e_n	Input voltage noise density	$V_S = 5\text{ V}$, $f = 1\text{ kHz}$		12		$\text{nV}/\sqrt{\text{Hz}}$
i_n	Input current noise density	$f = 1\text{ kHz}$		1.3		$\text{fA}/\sqrt{\text{Hz}}$
INPUT IMPEDANCE						
Z_{ID}	Differential			$2 \parallel 2$		$10^{16}\Omega \parallel \text{pF}$
Z_{IC}	Common-mode			$2 \parallel 4$		$10^{11}\Omega \parallel \text{pF}$
OPEN-LOOP GAIN						
A_{OL}	Open-loop voltage gain	$V_S = 5.5\text{ V}$, $(V-) + 0.05\text{ V} < V_O < (V+) - 0.05\text{ V}$, $R_L = 10\text{ k}\Omega$	100	104		dB
		$V_S = 5.5\text{ V}$, $(V-) + 0.15\text{ V} < V_O < (V+) - 0.15\text{ V}$, $R_L = 2\text{ k}\Omega$		104		
FREQUENCY RESPONSE						
GBP	Gain bandwidth product	$V_S = 5\text{ V}$, $G = 1$		10		MHz
ϕ_m	Phase margin	$V_S = 5\text{ V}$, $G = 1$		60		Degrees
SR	Slew rate	$V_S = 5\text{ V}$, $G = 1$		6		$\text{V}/\mu\text{s}$
t_S	Settling time	To 0.1%, $V_S = 5\text{ V}$, 2-V step, $G = 1$, $C_L = 100\text{ pF}$		1		μs
t_{OR}	Overload recovery time	$V_S = 5\text{ V}$, $V_{IN} \times \text{gain} = V_S$		0.8		μs
THD + N	Total harmonic distortion + noise ⁽¹⁾	$V_S = 5\text{ V}$, $V_O = 0.5 V_{RMS}$, $G = 1$, $f = 1\text{ kHz}$		0.008%		
OUTPUT						
V_O	Voltage output swing from supply rails	$V_S = 1.8\text{ V to }5.5\text{ V}$, $R_L = 10\text{ k}\Omega$			35	mV
		$V_S = 1.8\text{ to }5.5\text{ V}$, $R_L = 2\text{ k}\Omega$			125	
I_{SC}	Short-circuit current	$V_S = 5\text{ V}$		± 50		mA
Z_O	Open-loop output impedance	$V_S = 5\text{ V}$, $f = 10\text{ MHz}$		250		Ω
POWER SUPPLY						
V_S	Specified voltage range		1.8		5.5	V
I_Q	Quiescent current per amplifier	$V_S = 5\text{ V}$, $I_O = 0\text{ mA}$, $T_A = -40^\circ\text{C to }125^\circ\text{C}$		400	575	μA
TEMPERATURE						
T_A	Specified		-40		125	$^\circ\text{C}$
T_{stg}	Storage		-65		150	$^\circ\text{C}$

(1) Third-order filter; bandwidth = 80 kHz at -3 dB.

7.8 Typical Characteristics: Table of Graphs

表 1. Table of Graphs

TITLE	FIGURE
Offset Voltage Production Distribution	图 1
Offset Voltage vs Common-Mode Voltage	图 2
Open- Loop Gain and Phase vs Frequency	图 3
Input Bias and Offset Current vs Temperature	图 4
Input Voltage Noise Spectral Density vs Frequency	图 5
Quiescent Current vs Supply Voltage	图 6
Small-Signal Overshoot vs Load Capacitance	图 7
No Phase Reversal	图 8
Small-Signal Step Response	图 9
Large-Signal Step Response	图 10
Short-Circuit Current vs Temperature	图 11
Electromagnetic Interference Rejection Ratio Referred to Noninverting Input vs Frequency	图 12
Channel Separation vs Frequency	图 13

7.9 Typical Characteristics

at $T_A = 25^\circ\text{C}$, $V_S = 5.5\text{ V}$, $R_L = 10\text{ k}\Omega$ connected to $V_S / 2$, $V_{CM} = V_S / 2$, and $V_{OUT} = V_S / 2$, (unless otherwise noted)

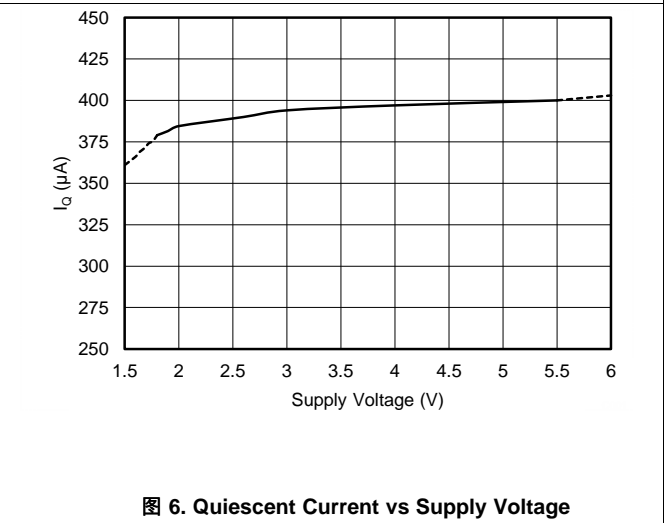
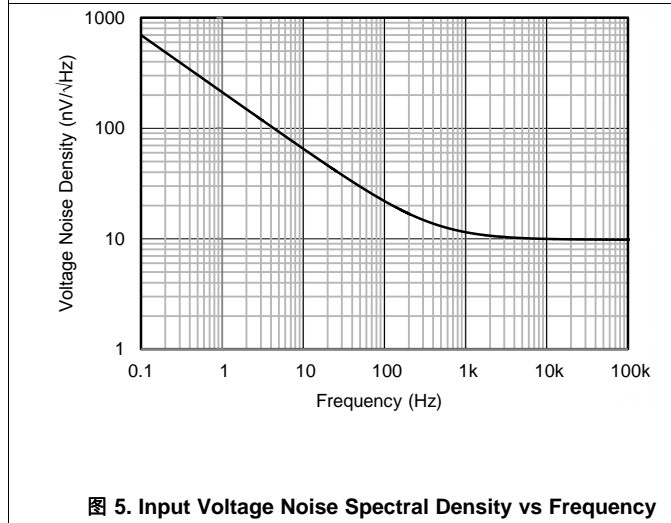
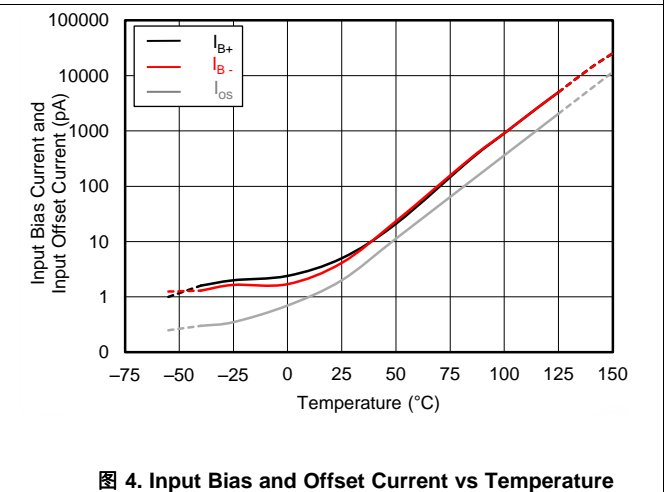
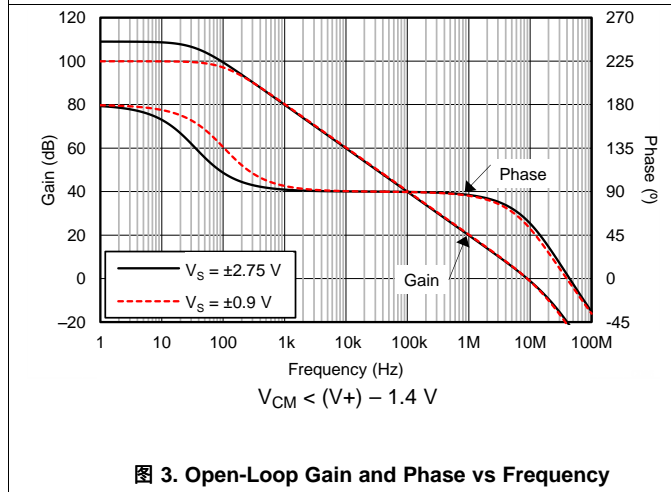
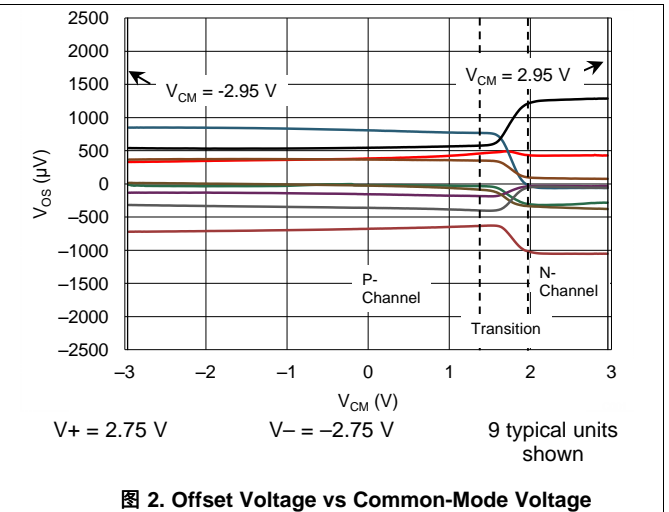
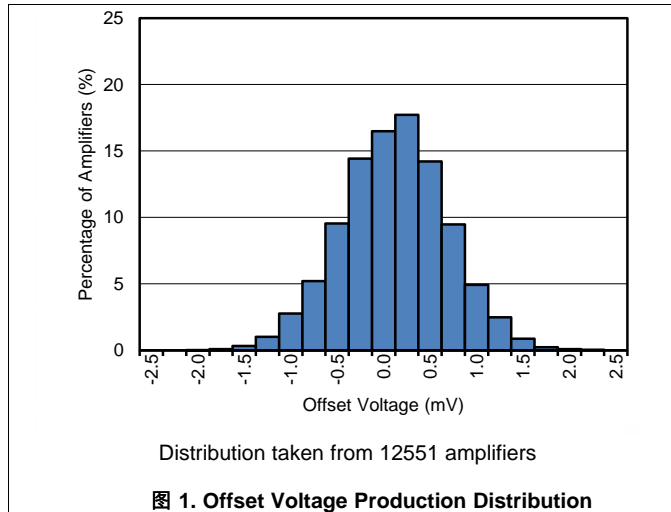

Typical Characteristics (接下页)

at $T_A = 25^\circ\text{C}$, $V_S = 5.5\text{ V}$, $R_L = 10\text{ k}\Omega$ connected to $V_S / 2$, $V_{CM} = V_S / 2$, and $V_{OUT} = V_S / 2$, (unless otherwise noted)



图 7. Small-Signal Overshoot vs Load Capacitance



图 8. No Phase Reversal

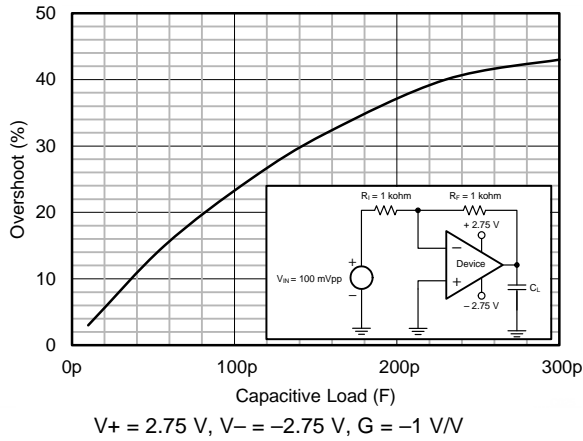

图 9. Small-Signal Step Response

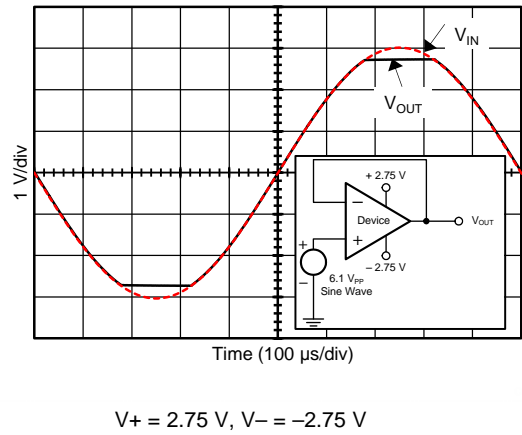

图 10. Large-Signal Step Response

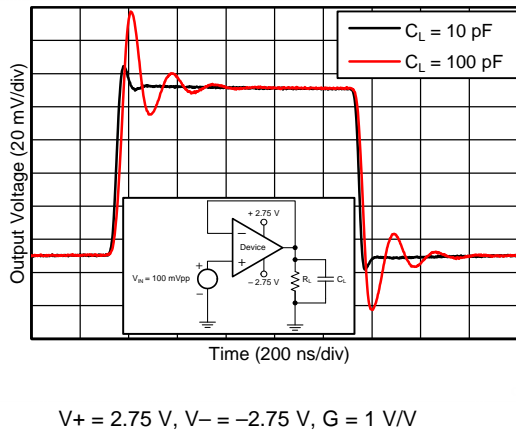

图 11. Short-Circuit Current vs Temperature

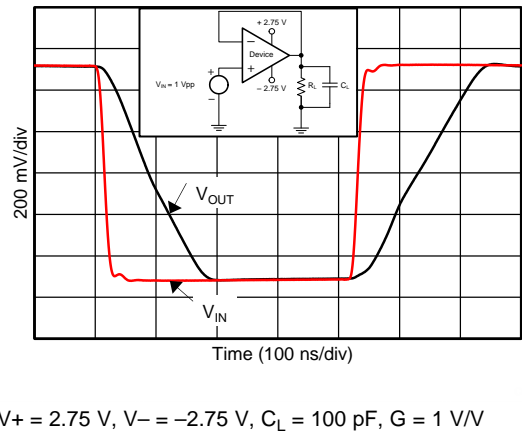

图 12. Electromagnetic Interference Rejection Ratio Referred to Noninverting Input vs Frequency

Typical Characteristics (接下页)

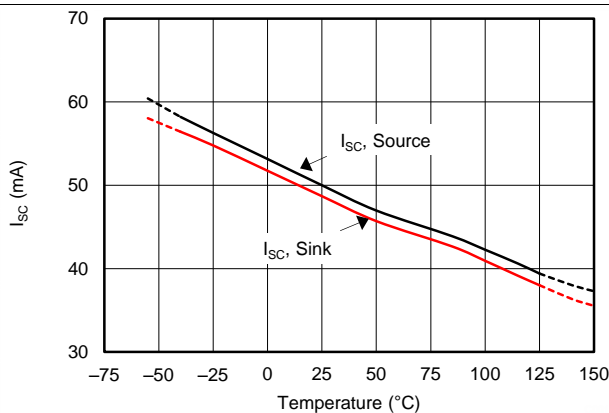
at $T_A = 25^\circ\text{C}$, $V_S = 5.5\text{ V}$, $R_L = 10\text{ k}\Omega$ connected to $V_S / 2$, $V_{CM} = V_S / 2$, and $V_{OUT} = V_S / 2$, (unless otherwise noted)

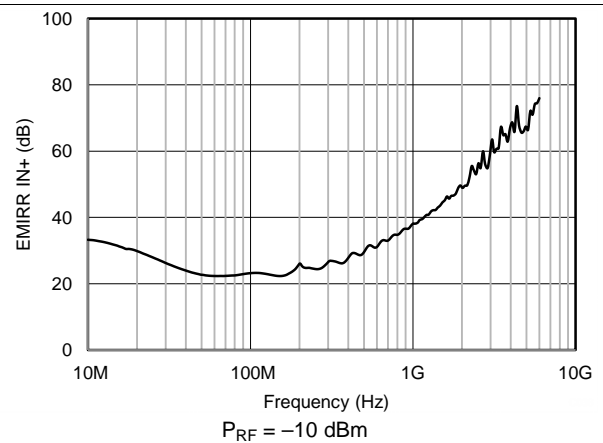

图 13. Channel Separation vs Frequency

8 Detailed Description

8.1 Overview

The TLVx316-Q1 is a family of low-power, rail-to-rail input and output operational amplifiers. These devices operate from 1.8 V to 5.5 V, are unity-gain stable, and are suitable for a wide range of general-purpose applications. The class AB output stage is capable of driving $\leq 10\text{-k}\Omega$ loads connected to any point between $V+$ and ground. The input common-mode voltage range includes both rails and allows the TLVx316-Q1 to be used in virtually any single-supply application. Rail-to-rail input and output swing significantly increases dynamic range, especially in low-supply applications, and makes them suitable for driving sampling analog-to-digital converters (ADCs).

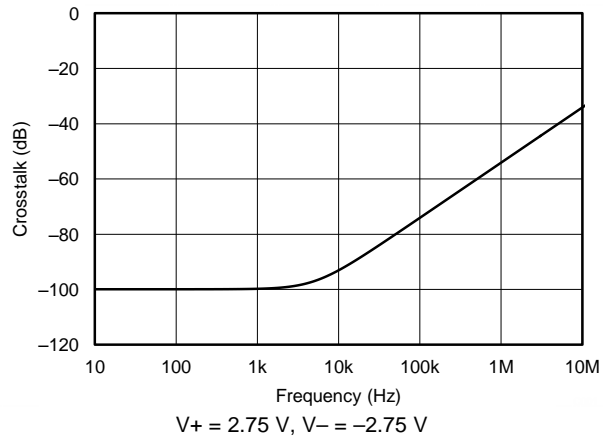
The TLVx316-Q1 features 10-MHz bandwidth and $6\text{-V}/\mu\text{s}$ slew rate with only $400\text{-}\mu\text{A}$ supply current per channel, providing good ac performance at very-low-power consumption. DC applications are well served with a very-low input noise voltage of $12\text{ nV}/\sqrt{\text{Hz}}$ at 1 kHz, low input bias current (5 pA), and an input offset voltage of 0.5 mV (typical).

8.2 Functional Block Diagram

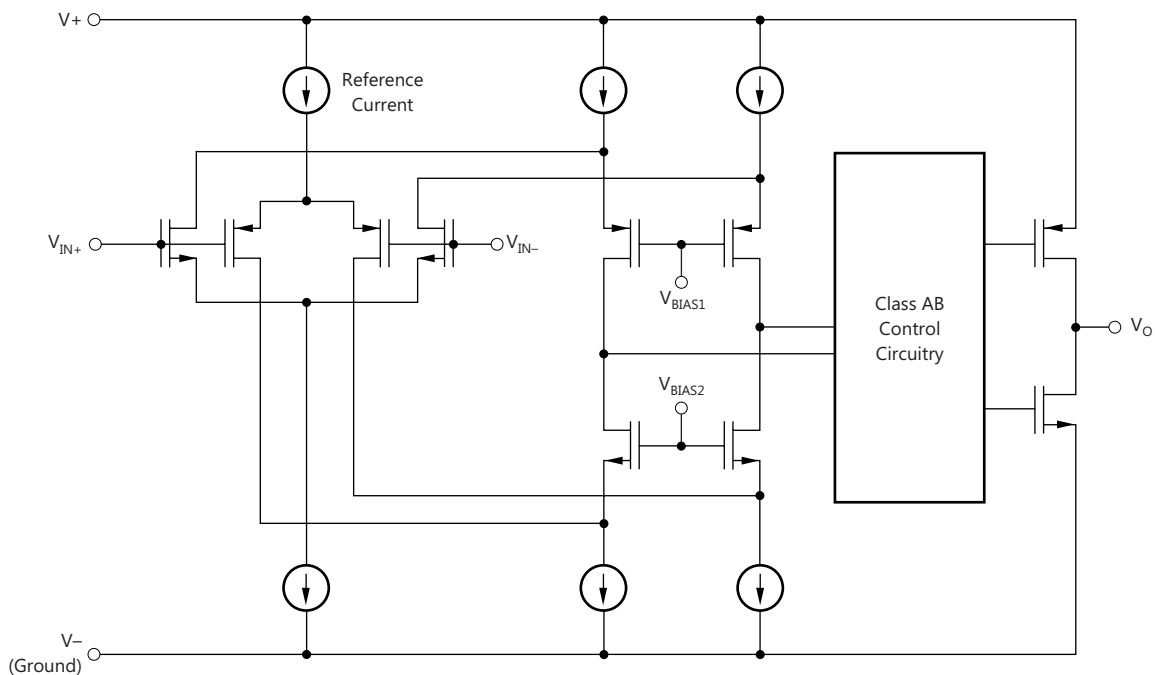

Copyright © 2017, Texas Instruments Incorporated

8.3 Feature Description

8.3.1 Operating Voltage

The TLVx316-Q1 operational amplifiers are fully specified and ensured for operation from 1.8 V to 5.5 V. In addition, many specifications apply from -40°C to $+125^{\circ}\text{C}$. Parameters that vary significantly with operating voltages or temperature are illustrated in the [Typical Characteristics](#) section.

8.3.2 Rail-to-Rail Input

The input common-mode voltage range of the TLVx316-Q1 extends 200 mV beyond the supply rails for supply voltages greater than 2.5 V. This performance is achieved with a complementary input stage: an N-channel input differential pair in parallel with a P-channel differential pair, as shown in the [Functional Block Diagram](#). The N-channel pair is active for input voltages close to the positive rail, typically $(V+) - 1.4\text{ V}$ to 200 mV above the positive supply, whereas the P-channel pair is active for inputs from 200 mV below the negative supply to approximately $(V+) - 1.4\text{ V}$. There is a small transition region, typically $(V+) - 1.2\text{ V}$ to $(V+) - 1\text{ V}$, in which both pairs are on. This 200-mV transition region can vary up to 200 mV with process variation. Thus, the transition region (both stages on) can range from $(V+) - 1.4\text{ V}$ to $(V+) - 1.2\text{ V}$ on the low end, up to $(V+) - 1\text{ V}$ to $(V+) - 0.8\text{ V}$ on the high end. Within this transition region, PSRR, CMRR, offset voltage, offset drift, and THD can be degraded compared to device operation outside this region.

8.3.3 Rail-to-Rail Output

Designed as a low-power, low-voltage operational amplifier, the TLVx316-Q1 delivers a robust output drive capability. A class AB output stage with common-source transistors is used to achieve full rail-to-rail output swing capability. For resistive loads of 10 k Ω , the output swings typically to within 30 mV of either supply rail regardless of the power-supply voltage applied. Different load conditions change the ability of the amplifier to swing close to the rails; see .

8.3.4 Common-Mode Rejection Ratio (CMRR)

CMRR for the TLVx316-Q1 is specified in two ways so the best match for a given application can be selected. The [Electrical Characteristics](#) table provides the CMRR of the device in the common-mode range below the transition region [$V_{\text{CM}} < (V+) - 1.4\text{ V}$]. This specification is the best indicator of device capability when the application requires using one of the differential input pairs. The CMRR over the entire common-mode range is specified at $V_{\text{CM}} = -0.2\text{ V}$ to 5.7 V for $V_{\text{S}} = 5.5\text{ V}$. This last value includes the variations through the transition region.

8.3.5 Capacitive Load and Stability

The TLVx316-Q1 is designed for applications where driving a capacitive load is required. As with all operational amplifiers, there may be specific instances where the TLVx316-Q1 can become unstable. The particular operational amplifier circuit configuration, layout, gain, and output loading are some of the factors to consider when establishing whether or not an amplifier is stable in operation. An operational amplifier in the unity-gain (1 V/V) buffer configuration that drives a capacitive load exhibits a greater tendency to be unstable than an amplifier operated at a higher noise gain. The capacitive load, in conjunction with the operational amplifier output resistance, creates a pole within the feedback loop that degrades the phase margin. The degradation of the phase margin increases when the capacitive loading increases. For a conservative best practice, designing for 25% overshoot (40° phase margin) provides improved stability over process variations. The equivalent series resistance (ESR) of some very-large capacitors (C_{L} capacitors with a value greater than 1 μF) is sufficient to alter the phase characteristics in the feedback loop such that the amplifier remains stable. Increasing the amplifier closed-loop gain allows the amplifier to drive increasingly larger capacitance. This increased capability is evident when observing the overshoot response of the amplifier at higher voltage gains, as shown in [Figure 7](#) ($G = -1\text{ V/V}$).

Feature Description (接下页)

One technique for increasing the capacitive load drive capability of the amplifier operating in a unity-gain configuration is to insert a small resistor (typically 10-Ω to 20-Ω) in series with the output, as shown in 图 14. This resistor significantly reduces the overshoot and ringing associated with large capacitive loads. One possible problem with this technique, however, is that a voltage divider is created with the added series resistor and any resistor connected in parallel with the capacitive load. The voltage divider introduces a gain error at the output that reduces the output swing.



图 14. Improving Capacitive Load Drive

8.3.6 EMI Susceptibility and Input Filtering

Operational amplifiers vary with regard to the susceptibility of the device to electromagnetic interference (EMI). If conducted EMI enters the operational amplifier, the dc offset measured at the amplifier output can shift from the nominal value when EMI is present. This shift is a result of signal rectification associated with the internal semiconductor junctions. Although EMI can affect all operational amplifier pin functions, the signal input pins are likely to be the most susceptible. The TLVx316-Q1 operational amplifier family incorporates an internal input low-pass filter that reduces the amplifier response to EMI. This filter provides both common-mode and differential-mode filtering. The filter is designed for a cutoff frequency of approximately 80 MHz (–3 dB), with a roll-off of 20 dB per decade.

The immunity of an operational amplifier can be accurately measured and quantified over a broad frequency spectrum extending from 10 MHz to 6 GHz. The EMI rejection ratio (EMIRR) metric allows operational amplifiers to be directly compared by the EMI immunity. 图 12 illustrates the results of this testing on the TLVx316-Q1. Detailed information can be found in [EMI Rejection Ratio of Operational Amplifiers](#), available for download from www.ti.com.

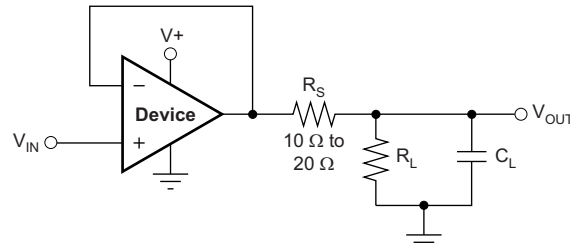
8.3.7 Overload Recovery

Overload recovery is defined as the time required for the operational amplifier output to recover from a saturated state to a linear state. The output devices of the operational amplifier enter a saturation region when the output voltage exceeds the rated operating voltage, either because of the high input voltage or the high gain. After the device enters the saturation region, the charge carriers in the output devices require time to return back to the linear state. After the charge carriers return back to the linear state, the device begins to slew at the specified slew rate. Thus, the propagation delay in case of an overload condition is the sum of the overload recovery time and the slew time. The overload recovery time for the TLVx316-Q1 is approximately 300 ns.

8.4 Device Functional Modes

The TLVx316-Q1 family has a single functional mode. These devices are powered on as long as the power-supply voltage is between 1.8 V (±0.9 V) and 5.5 V (±2.75 V).

9 Application and Implementation

注

Information in the following applications sections is not part of the TI component specification, and TI does not warrant its accuracy or completeness. TI's customers are responsible for determining suitability of components for their purposes. Customers should validate and test their design implementation to confirm system functionality.

9.1 Application Information

The TLV316-Q1, TLV2316-Q1, and TLV4316-Q1 devices are powered on when the supply is connected. The devices can operate as a single-supply operational amplifier or a dual-supply amplifier, depending on the application.

9.2 System Examples

When receiving low-level signals, the device often requires limiting the bandwidth of the incoming signals into the system. The simplest way to establish this limited bandwidth is to place an RC filter at the noninverting pin of the amplifier, as shown in 图 15.

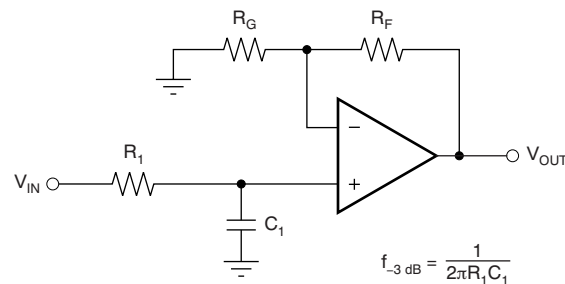

$$f_{-3\text{ dB}} = \frac{1}{2\pi R_1 C_1}$$

$$\frac{V_{\text{OUT}}}{V_{\text{IN}}} = \left(1 + \frac{R_F}{R_G}\right) \left(\frac{1}{1 + sR_1 C_1}\right)$$

图 15. Single-Pole, Low-Pass Filter

If even more attenuation is needed, the device requires a multiple-pole filter. The Sallen-Key filter can be used for this task, as shown in 图 16. For best results, the amplifier must have a bandwidth that is eight to ten times the filter frequency bandwidth. Failure to follow this guideline can result in a phase shift of the amplifier.

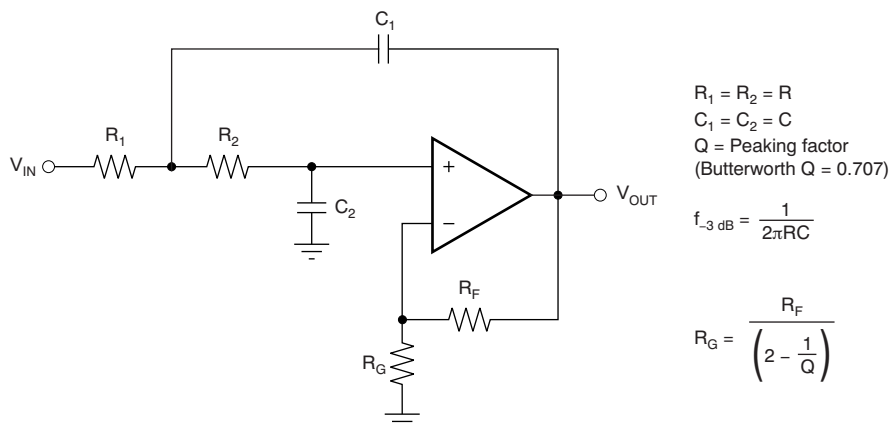

$$R_1 = R_2 = R$$

$$C_1 = C_2 = C$$

$$Q = \text{Peaking factor}$$

(Butterworth Q = 0.707)

$$f_{-3\text{ dB}} = \frac{1}{2\pi RC}$$

$$R_G = \frac{R_F}{\left(2 - \frac{1}{Q}\right)}$$

图 16. Two-Pole, Low-Pass, Sallen-Key Filter

10 Power Supply Recommendations

The TLVx316-Q1 family is specified for operation from 1.8 V to 5.5 V (± 0.9 V to ± 2.75 V); many specifications apply from -40°C to $+125^{\circ}\text{C}$. The [Typical Characteristics](#) section presents parameters that can exhibit significant variance with regard to operating voltage or temperature.

CAUTION

Supply voltages larger than 7 V can permanently damage the device; see the [Absolute Maximum Ratings](#) table.

Place 0.1- μF bypass capacitors close to the power-supply pins to reduce errors coupling in from noisy or high-impedance power supplies. For more detailed information on bypass capacitor placement, see the [Layout Guidelines](#) section.

10.1 Input and ESD Protection

The TLVx316-Q1 incorporates internal ESD protection circuits on all pins. For input and output pins, this protection primarily consists of current-steering diodes connected between the input and power-supply pins. These ESD protection diodes provide in-circuit, input overdrive protection, as long as the current is limited to 10 mA, as stated in the [Absolute Maximum Ratings](#) table. [Figure 17](#) shows how a series input resistor can be added to the driven input to limit the input current. The added resistor contributes thermal noise at the amplifier input and the value must be kept to a minimum in noise-sensitive applications.



图 17. Input Current Protection

11 Layout

11.1 Layout Guidelines

For best operational performance of the device, use good PCB layout practices, including:

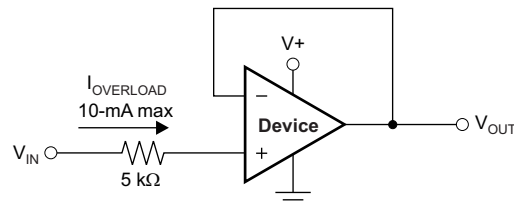
- Noise can propagate into analog circuitry through the power pins of the circuit as a whole and the operational amplifier. Bypass capacitors reduce the coupled noise by providing low-impedance power sources local to the analog circuitry.
 - Connect low-ESR, 0.1- μ F ceramic bypass capacitors between each supply pin and ground, placed as close to the device as possible. A single bypass capacitor from V+ to ground is applicable for single-supply applications.
- Separate grounding for analog and digital portions of the circuitry is one of the simplest and most effective methods of noise suppression. One or more layers on multilayer PCBs are typically devoted to ground planes. A ground plane helps distribute heat and reduces EMI noise pickup. Take care to physically separate digital and analog grounds, paying attention to the flow of the ground current. For more detailed information, see [Circuit Board Layout Techniques](#).
- To reduce parasitic coupling, run the input traces as far away from the supply or output traces as possible. If these traces cannot be kept separate, crossing the sensitive trace perpendicularly is much better than crossing in parallel with the noisy trace.
- Place the external components as close to the device as possible. Keeping R_F and R_G close to the inverting input minimizes parasitic capacitance, as shown in [Figure 18](#).
- Keep the length of input traces as short as possible. Remember that the input traces are the most sensitive part of the circuit.
- Consider a driven, low-impedance guard ring around the critical traces. A guard ring can significantly reduce leakage currents from nearby traces that are at different potentials.

11.2 Layout Example

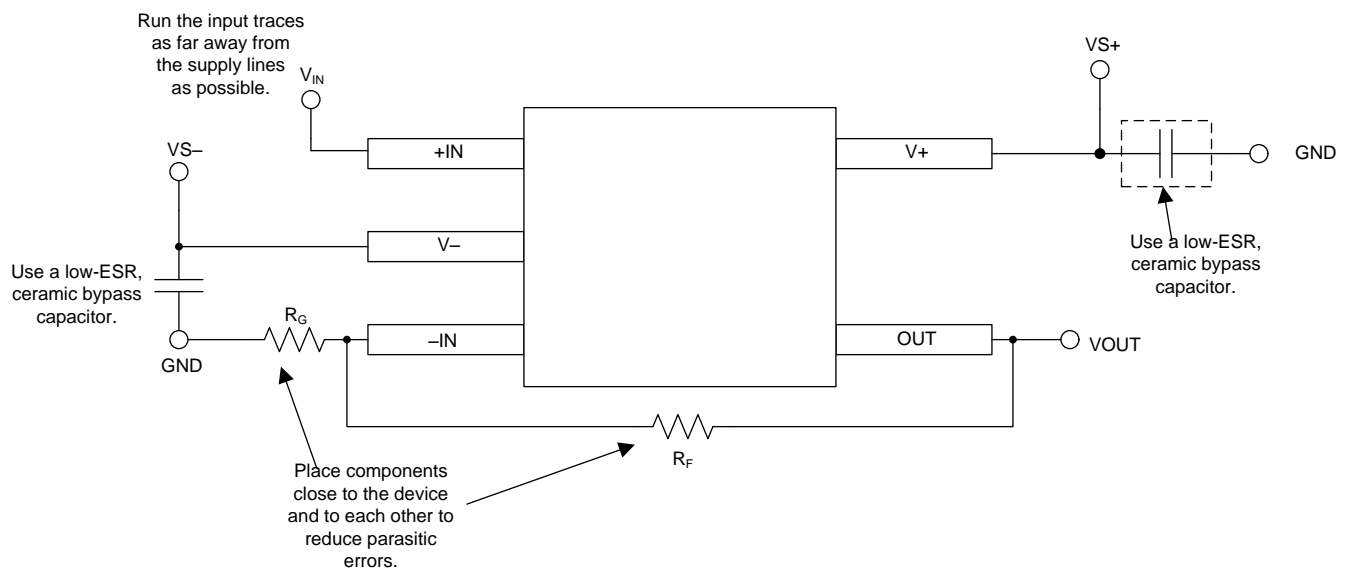

Copyright © 2016, Texas Instruments Incorporated

图 18. Operational Amplifier Board Layout for a Noninverting Configuration

12 器件和文档支持

12.1 文档支持

中文档参考的固定文献编号

12.1.1 相关文档

《TLVx313 面向成本敏感型系统的低功耗、轨到轨输入/输出、500 μ V 典型偏移值、1MHz 运算放大器》

TLVx314 3MHz、低功耗、内部 EMI 滤波器、RRIO 运算放大器

《运算放大器的电磁干扰 (EMI) 抑制比》

《QFN/SON PCB 连接》

《四方扁平无引线逻辑器件封装》

《电路板布局布线技巧》

单端输入至差动输出转换电路参考设计

12.2 相关链接

下表列出了快速访问链接。类别包括技术文档、支持和社区资源、工具和软件以及立即订购快速访问。

表 2. 相关链接

器件	产品文件夹	立即订购	技术文档	工具和软件	支持和社区
TLV316-Q1	请单击此处	请单击此处	请单击此处	请单击此处	请单击此处
TLV2316-Q1	请单击此处	请单击此处	请单击此处	请单击此处	请单击此处
TLV4316-Q1	请单击此处	请单击此处	请单击此处	请单击此处	请单击此处

12.3 社区资源

下列链接提供到 TI 社区资源的连接。链接的内容由各个分销商“按照原样”提供。这些内容并不构成 TI 技术规范，并且不一定反映 TI 的观点；请参阅 TI 的《使用条款》。

TI E2E™ 在线社区 **TI 的工程师对工程师 (E2E) 社区**。此社区的创建目的在于促进工程师之间的协作。在 e2e.ti.com 中，您可以咨询问题、分享知识、拓展思路并与同行工程师一道帮助解决问题。

设计支持 **TI 参考设计支持** 可帮助您快速查找有帮助的 E2E 论坛、设计支持工具以及技术支持的联系信息。

12.4 商标

E2E is a trademark of Texas Instruments.

12.5 静电放电警告



ESD 可能会损坏该集成电路。德州仪器 (TI) 建议通过适当的预防措施处理所有集成电路。如果不遵守正确的处理措施和安装程序，可能会损坏集成电路。

ESD 的损坏小至导致微小的性能降级，大至整个器件故障。精密的集成电路可能更容易受到损坏，这是因为非常细微的参数更改都可能会导致器件与其发布的规格不相符。

12.6 Glossary

[SLYZ022](#) — *TI Glossary*.

This glossary lists and explains terms, acronyms, and definitions.

13 机械、封装和可订购信息

以下页面包含机械、封装和可订购信息。这些信息是指定器件的最新可用数据。这些数据如有变更，恕不另行通知和修订此文档。如欲获取此产品说明书的浏览器版本，请参阅左侧的导航。

PACKAGING INFORMATION

Orderable Device	Status (1)	Package Type	Package Drawing	Pins	Package Qty	Eco Plan (2)	Lead finish/ Ball material (6)	MSL Peak Temp (3)	Op Temp (°C)	Device Marking (4/5)	Samples
TLV2316QDGKRQ1	ACTIVE	VSSOP	DGK	8	2500	RoHS & Green	NIPDAUAG	Level-2-260C-1 YEAR	-40 to 125	16M6	Samples
TLV2316QDGKTQ1	ACTIVE	VSSOP	DGK	8	250	RoHS & Green	NIPDAUAG	Level-2-260C-1 YEAR	-40 to 125	16M6	Samples
TLV316QDBVRQ1	ACTIVE	SOT-23	DBV	5	3000	RoHS & Green	NIPDAU	Level-2-260C-1 YEAR	-40 to 125	16ND	Samples
TLV316QDBVTQ1	ACTIVE	SOT-23	DBV	5	250	RoHS & Green	NIPDAU SN	Level-2-260C-1 YEAR	-40 to 125	16ND	Samples
TLV4316QPWRQ1	ACTIVE	TSSOP	PW	14	2000	RoHS & Green	NIPDAU	Level-2-260C-1 YEAR	-40 to 125	V4316Q1	Samples

(1) The marketing status values are defined as follows:

ACTIVE: Product device recommended for new designs.

LIFEBUY: TI has announced that the device will be discontinued, and a lifetime-buy period is in effect.

NRND: Not recommended for new designs. Device is in production to support existing customers, but TI does not recommend using this part in a new design.

PREVIEW: Device has been announced but is not in production. Samples may or may not be available.

OBSELETE: TI has discontinued the production of the device.

(2) **RoHS:** TI defines "RoHS" to mean semiconductor products that are compliant with the current EU RoHS requirements for all 10 RoHS substances, including the requirement that RoHS substance do not exceed 0.1% by weight in homogeneous materials. Where designed to be soldered at high temperatures, "RoHS" products are suitable for use in specified lead-free processes. TI may reference these types of products as "Pb-Free".

RoHS Exempt: TI defines "RoHS Exempt" to mean products that contain lead but are compliant with EU RoHS pursuant to a specific EU RoHS exemption.

Green: TI defines "Green" to mean the content of Chlorine (Cl) and Bromine (Br) based flame retardants meet JS709B low halogen requirements of <=1000ppm threshold. Antimony trioxide based flame retardants must also meet the <=1000ppm threshold requirement.

(3) MSL, Peak Temp. - The Moisture Sensitivity Level rating according to the JEDEC industry standard classifications, and peak solder temperature.

(4) There may be additional marking, which relates to the logo, the lot trace code information, or the environmental category on the device.

(5) Multiple Device Markings will be inside parentheses. Only one Device Marking contained in parentheses and separated by a "~" will appear on a device. If a line is indented then it is a continuation of the previous line and the two combined represent the entire Device Marking for that device.

(6) Lead finish/Ball material - Orderable Devices may have multiple material finish options. Finish options are separated by a vertical ruled line. Lead finish/Ball material values may wrap to two lines if the finish value exceeds the maximum column width.

Important Information and Disclaimer:The information provided on this page represents TI's knowledge and belief as of the date that it is provided. TI bases its knowledge and belief on information provided by third parties, and makes no representation or warranty as to the accuracy of such information. Efforts are underway to better integrate information from third parties. TI has taken and continues to take reasonable steps to provide representative and accurate information but may not have conducted destructive testing or chemical analysis on incoming materials and chemicals. TI and TI suppliers consider certain information to be proprietary, and thus CAS numbers and other limited information may not be available for release.

In no event shall TI's liability arising out of such information exceed the total purchase price of the TI part(s) at issue in this document sold by TI to Customer on an annual basis.

OTHER QUALIFIED VERSIONS OF TLV2316-Q1, TLV316-Q1, TLV4316-Q1 :

- Catalog : [TLV2316](#), [TLV316](#), [TLV4316](#)

NOTE: Qualified Version Definitions:

- Catalog - TI's standard catalog product

TAPE AND REEL INFORMATION

QUADRANT ASSIGNMENTS FOR PIN 1 ORIENTATION IN TAPE

*All dimensions are nominal

Device	Package Type	Package Drawing	Pins	SPQ	Reel Diameter (mm)	Reel Width W1 (mm)	A0 (mm)	B0 (mm)	K0 (mm)	P1 (mm)	W (mm)	Pin1 Quadrant
TLV2316QDGKRQ1	VSSOP	DGK	8	2500	330.0	12.4	5.3	3.4	1.4	8.0	12.0	Q1
TLV2316QDGKTQ1	VSSOP	DGK	8	250	330.0	12.4	5.3	3.4	1.4	8.0	12.0	Q1
TLV316QDBVRQ1	SOT-23	DBV	5	3000	178.0	9.0	3.3	3.2	1.4	4.0	8.0	Q3
TLV316QDBVTQ1	SOT-23	DBV	5	250	178.0	9.0	3.3	3.2	1.4	4.0	8.0	Q3
TLV4316QPWRQ1	TSSOP	PW	14	2000	330.0	12.4	6.9	5.6	1.6	8.0	12.0	Q1

TAPE AND REEL BOX DIMENSIONS

*All dimensions are nominal

Device	Package Type	Package Drawing	Pins	SPQ	Length (mm)	Width (mm)	Height (mm)
TLV2316QDGKRQ1	VSSOP	DGK	8	2500	366.0	364.0	50.0
TLV2316QDGKTQ1	VSSOP	DGK	8	250	366.0	364.0	50.0
TLV316QDBVRQ1	SOT-23	DBV	5	3000	180.0	180.0	18.0
TLV316QDBVTQ1	SOT-23	DBV	5	250	180.0	180.0	18.0
TLV4316QPWRQ1	TSSOP	PW	14	2000	356.0	356.0	35.0

PW (R-PDSO-G14)

PLASTIC SMALL OUTLINE



4040064-3/G 02/11

- NOTES:
- A. All linear dimensions are in millimeters. Dimensioning and tolerancing per ASME Y14.5M-1994.
 - B. This drawing is subject to change without notice.
 - C. Body length does not include mold flash, protrusions, or gate burrs. Mold flash, protrusions, or gate burrs shall not exceed 0,15 each side.
 - D. Body width does not include interlead flash. Interlead flash shall not exceed 0,25 each side.
 - E. Falls within JEDEC MO-153

DBV0005A



PACKAGE OUTLINE

SOT-23 - 1.45 mm max height

SMALL OUTLINE TRANSISTOR

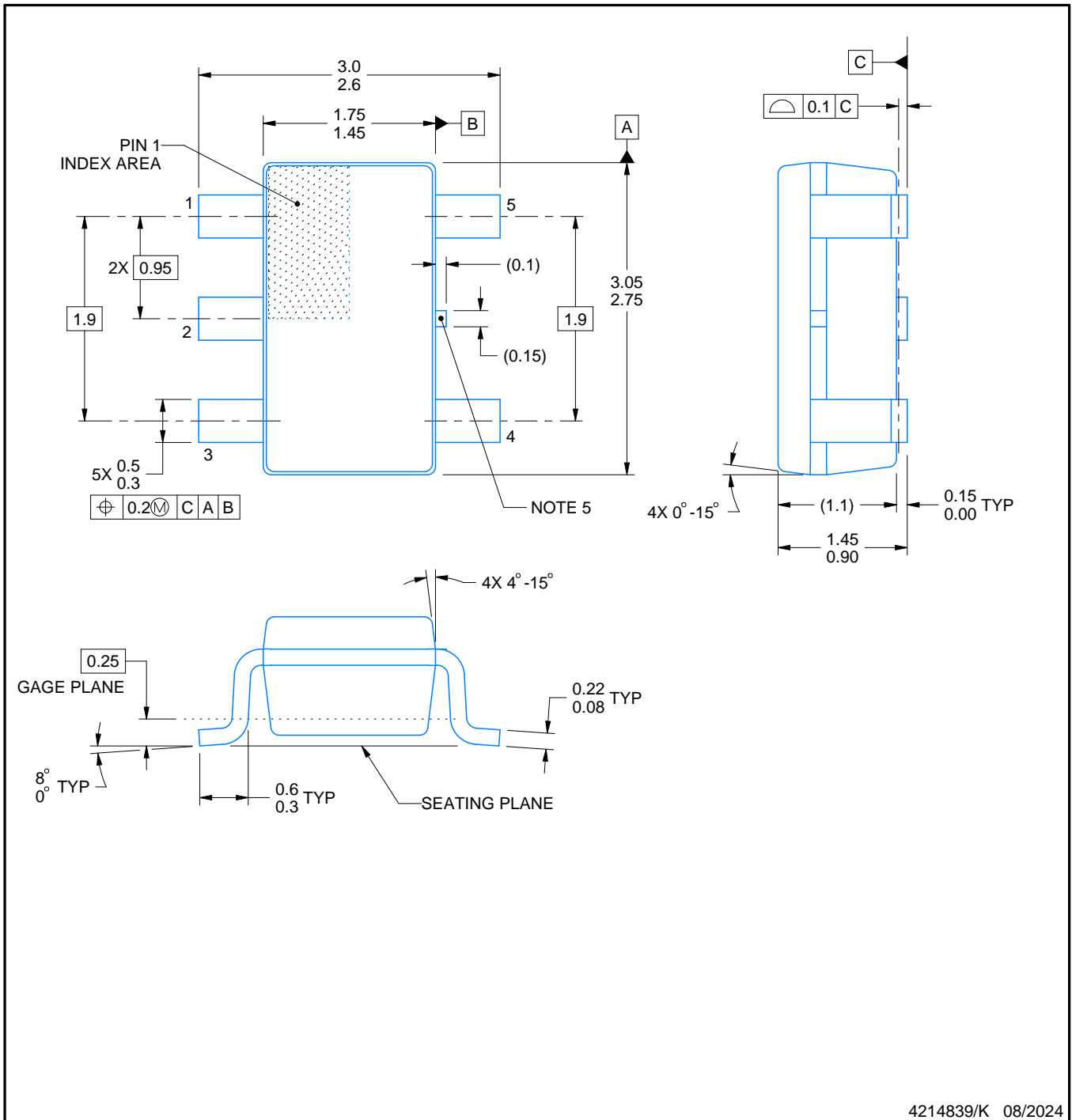

4214839/K 08/2024

EXAMPLE BOARD LAYOUT

DBV0005A

SOT-23 - 1.45 mm max height

SMALL OUTLINE TRANSISTOR



LAND PATTERN EXAMPLE
EXPOSED METAL SHOWN
SCALE:15X



SOLDER MASK DETAILS

4214839/K 08/2024

NOTES: (continued)

- 6. Publication IPC-7351 may have alternate designs.
- 7. Solder mask tolerances between and around signal pads can vary based on board fabrication site.

EXAMPLE STENCIL DESIGN

DBV0005A

SOT-23 - 1.45 mm max height

SMALL OUTLINE TRANSISTOR



SOLDER PASTE EXAMPLE
BASED ON 0.125 mm THICK STENCIL
SCALE:15X

4214839/K 08/2024

NOTES: (continued)

8. Laser cutting apertures with trapezoidal walls and rounded corners may offer better paste release. IPC-7525 may have alternate design recommendations.
9. Board assembly site may have different recommendations for stencil design.

DGK0008A

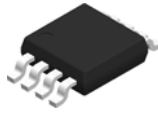

PACKAGE OUTLINE

VSSOP - 1.1 mm max height

SMALL OUTLINE PACKAGE



NOTES:

PowerPAD is a trademark of Texas Instruments.

1. All linear dimensions are in millimeters. Any dimensions in parenthesis are for reference only. Dimensioning and tolerancing per ASME Y14.5M.
2. This drawing is subject to change without notice.
3. This dimension does not include mold flash, protrusions, or gate burrs. Mold flash, protrusions, or gate burrs shall not exceed 0.15 mm per side.
4. This dimension does not include interlead flash. Interlead flash shall not exceed 0.25 mm per side.
5. Reference JEDEC registration MO-187.

EXAMPLE BOARD LAYOUT

DGK0008A

™ VSSOP - 1.1 mm max height

SMALL OUTLINE PACKAGE



LAND PATTERN EXAMPLE
EXPOSED METAL SHOWN
SCALE: 15X

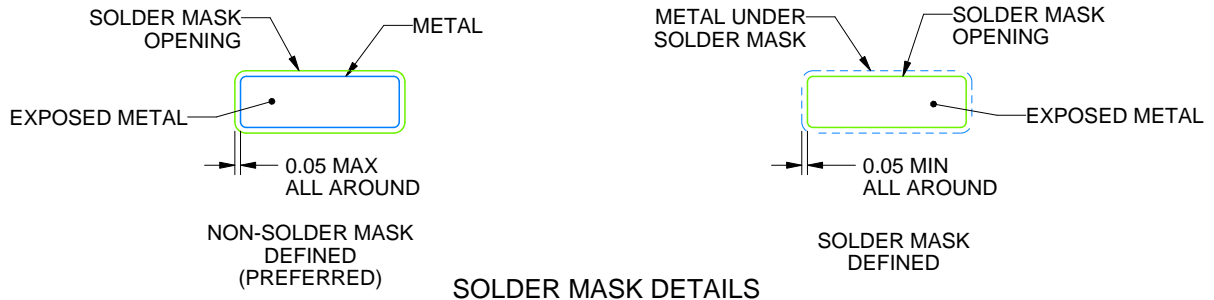

4214862/A 04/2023

NOTES: (continued)

6. Publication IPC-7351 may have alternate designs.
7. Solder mask tolerances between and around signal pads can vary based on board fabrication site.
8. Vias are optional depending on application, refer to device data sheet. If any vias are implemented, refer to their locations shown on this view. It is recommended that vias under paste be filled, plugged or tented.
9. Size of metal pad may vary due to creepage requirement.

EXAMPLE STENCIL DESIGN

DGK0008A

TM VSSOP - 1.1 mm max height

SMALL OUTLINE PACKAGE



SOLDER PASTE EXAMPLE
SCALE: 15X

4214862/A 04/2023

NOTES: (continued)

11. Laser cutting apertures with trapezoidal walls and rounded corners may offer better paste release. IPC-7525 may have alternate design recommendations.
12. Board assembly site may have different recommendations for stencil design.

重要声明和免责声明

TI“按原样”提供技术和可靠性数据（包括数据表）、设计资源（包括参考设计）、应用或其他设计建议、网络工具、安全信息和其他资源，不保证没有瑕疵且不做任何明示或暗示的担保，包括但不限于对适销性、某特定用途方面的适用性或不侵犯任何第三方知识产权的暗示担保。

这些资源可供使用 TI 产品进行设计的熟练开发人员使用。您将自行承担以下全部责任：(1) 针对您的应用选择合适的 TI 产品，(2) 设计、验证并测试您的应用，(3) 确保您的应用满足相应标准以及任何其他功能安全、信息安全、监管或其他要求。

这些资源如有变更，恕不另行通知。TI 授权您仅可将这些资源用于研发本资源所述的 TI 产品的应用。严禁对这些资源进行其他复制或展示。您无权使用任何其他 TI 知识产权或任何第三方知识产权。您应全额赔偿因在这些资源的使用中对 TI 及其代表造成的任何索赔、损害、成本、损失和债务，TI 对此概不负责。

TI 提供的产品受 [TI 的销售条款](#) 或 [ti.com](#) 上其他适用条款/TI 产品随附的其他适用条款的约束。TI 提供这些资源并不会扩展或以其他方式更改 TI 针对 TI 产品发布的适用的担保或担保免责声明。

TI 反对并拒绝您可能提出的任何其他或不同的条款。

邮寄地址：Texas Instruments, Post Office Box 655303, Dallas, Texas 75265

Copyright © 2024，德州仪器 (TI) 公司