

# ADC12DJ3200 6.4GSPS 单通道或 3.2GSPS 双通道 12 位射频采样模数转换器 (ADC)

## 1 特性

- ADC 内核:
  - 12 位分辨率
  - 单通道模式下采样率高达 6.4GSPS
  - 双通道模式下采样率高达 3.2GSPS
- 性能规格:
  - 本底噪声 (无信号,  $V_{FS} = 1.0V_{PP-DIFF}$ ):
    - 双通道模式:  $-151.8\text{dBFS/Hz}$
    - 单通道模式:  $-154.6\text{dBFS/Hz}$
  - HD2、HD3:  $-65\text{dBc}$ , 高达 3GHz
- $V_{CM}$  为 0V 时的缓冲模拟输入:
  - 模拟输入带宽 ( $-3\text{dB}$ ): 8.0GHz
  - 可用输入频率范围:  $>10\text{GHz}$
  - 满量程输入电压 ( $V_{FS}$ , 默认值):  $0.8V_{PP}$
  - 模拟输入共模电压 ( $V_{ICM}$ ): 0V
- 无噪声孔径延迟 ( $T_{AD}$ ) 调节:
  - 采样精度控制: 19fs 步长
  - 简化同步和交错
  - 温度和电压不变延迟
- 简便易用的同步特性:
  - 自动 SYSREF 计时校准
  - 样片标记时间戳
- JESD204B 串行数据接口:
  - 支持子类 0 和 1
  - 最大通道速率: 12.8Gbps
  - 多达 16 个通道可降低通道速率
- 双通道模式下的数字下变频器:
  - 实际输出: DDC 旁路或双倍抽取
  - 复杂输出: 4 倍、8 倍或 16 倍抽取
  - 每个 DDC 均具有四个独立的 32 位 NCO
- 功耗: 3W
- 电源电压: 1.1V、1.9V

## 2 应用

- 通信测试仪 (802.11ad, 5G)
- 卫星通信 (SATCOM)
- 相控阵雷达、信号情报和电子情报
- 合成孔径雷达 (SAR)
- 飞行时间和激光雷达测距
- 示波器和宽带数字转换器
- 微波回程连线
- 射频采样软件定义无线电 (SDR)
- 光谱测量

## 3 说明

ADC12DJ3200 器件是一款射频采样千兆采样模数转换器 (ADC), 可对从直流到 10GHz 以上的输入频率进行直接采样。在双通道下, ADC12DJ3200 的最大采样率为 3200MSPS, 单通道模式下的最大采样率为 6400MSPS。通道数 (双通道模式) 和奈斯特带宽 (单通道模式) 的可编程交换功能可用于开发灵活的硬件, 以满足高通道数或宽瞬时信号带宽 应用的需求。8.0GHz 的全功率输入带宽 ( $-3\text{dB}$ ), 可用频率在双通道和单通道模式下均超过  $-3\text{dB}$ , 可对频率捷变系统的 L、S、C 和 X 频带进行直接射频采样。

ADC12DJ3200 采用具有多达 16 个串行通道和子类 1 兼容性的高速 JESD204B 输出接口, 可实现确定性延迟和多器件同步。串行输出通道支持高达 12.8Gbps 的速率, 并可配置交换位速率和通道数。创新同步 具有无噪声孔径延迟 ( $T_{AD}$ ) 调节和 SYSREF 窗口等创新的同步特性, 简化了相控阵雷达和 MIMO 通信的系统设计。采用双通道模式的可选数字下变频器 (DDC) 可以降低接口速率 (实际和复杂抽取模式), 支持数字化信号混合 (仅复杂抽取模式)。

### 器件信息<sup>(1)</sup>

器件型号	封装	封装尺寸 (标称值)
ADC12DJ3200	FCBGA (144)	10.00mm x 10.00mm

(1) 如需了解所有可用封装, 请参见数据表末尾的封装选项附录。

ADC12DJ3200 测量的输入带宽

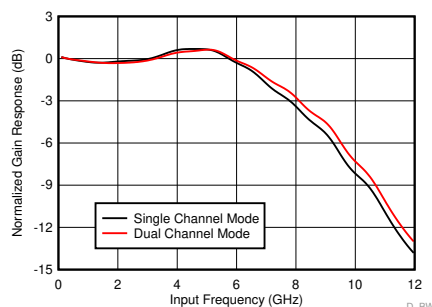

## 目录

1	特性 .....	1	7.3	Feature Description .....	38
2	应用 .....	1	7.4	Device Functional Modes .....	62
3	说明 .....	1	7.5	Programming .....	81
4	修订历史记录 .....	2	7.6	Register Maps .....	82
5	<b>Pin Configuration and Functions</b> .....	4	8	<b>Application and Implementation</b> .....	132
6	<b>Specifications</b> .....	9	8.1	Application Information .....	132
6.1	Absolute Maximum Ratings .....	9	8.2	Typical Applications .....	132
6.2	ESD Ratings .....	9	8.3	Initialization Set Up .....	139
6.3	Recommended Operating Conditions .....	10	9	<b>Power Supply Recommendations</b> .....	139
6.4	Thermal Information .....	10	9.1	Power Sequencing .....	141
6.5	Electrical Characteristics - DC Specifications .....	11	10	<b>Layout</b> .....	141
6.6	Electrical Characteristics - Power Consumption .....	13	10.1	Layout Guidelines .....	141
6.7	Electrical Characteristics: AC Specifications (Dual-Channel Mode) .....	14	10.2	Layout Example .....	142
6.8	Electrical Characteristics: AC Specifications (Single-Channel Mode) .....	17	11	<b>器件和文档支持</b> .....	145
6.9	Timing Requirements .....	20	11.1	器件支持 .....	145
6.10	Switching Characteristics .....	21	11.2	文档支持 .....	145
6.11	Typical Characteristics .....	25	11.3	接收文档更新通知 .....	145
7	<b>Detailed Description</b> .....	37	11.4	支持资源 .....	145
7.1	Overview .....	37	11.5	商标 .....	145
7.2	Functional Block Diagram .....	38	11.6	静电放电警告 .....	146
			11.7	Glossary .....	146
			12	<b>机械、封装和可订购信息</b> .....	146

## 4 修订历史记录

注：之前版本的页码可能与当前版本有所不同。

Changes from Original (June 2017) to Revision A	Page
• Changed <i>Pin Functions</i> table listed in alphanumeric order by pin name. ....	5
• Deleted reference to footnote below the <i>Recommended Operating Conditions</i> table and moved the information to the <i>Power-Down Mode</i> section. ....	7
• Deleted note underneath the <i>Recommended Operating Conditions</i> table regarding reliable serializer operation. The information has moved to the <i>Power-Down Modes</i> section. ....	10
• Changed <i>Electrical Characteristics - AC Specifications</i> table to include only the Dual-Channel Mode specifications and renamed the table to <i>Electrical Characteristics: AC Specifications (Dual-Channel Mode)</i> . Single-Channel Mode specifications have been split into a separate table for ease of reading. ....	14
• Added <i>Electrical Characteristics: AC Specifications (Single-Channel Mode)</i> table to make the specification tables easier to read. ....	17
• Changed figure order in <i>Typical Characteristics</i> section .....	25
• Added FG calibration to conditions of <i>ENOB vs Input Frequency</i> figure .....	25
• Changed title of <i>HD2, HD3, THD vs Input Frequency</i> figure. ....	26
• Added $f_{CLK} = 3200\text{ MHz}$ to conditions of <i>SNR, SINAD, SFDR vs Temperature</i> figure .....	31
• Added $f_{CLK} = 3200\text{ MHz}$ to conditions of <i>HD2, HD3, THD vs Temperature</i> figure .....	31
• Changed title of <i>ENOB vs Temperature and Calibration Type</i> figure .....	31
• Added $f_{CLK} = 3200\text{ MHz}$ to conditions of <i>ENOB vs Temperature and Calibration Type</i> figure .....	31
• Added $f_{CLK} = 3200\text{ MHz}$ to conditions of <i>SNR, SINAD, SFDR vs Supply Voltage</i> figure. ....	32
• Added $f_{CLK} = 3200\text{ MHz}$ to conditions of <i>ENOB vs Supply Voltage</i> figure .....	32
• Added $f_{CLK} = 3200\text{ MHz}$ to conditions of <i>HD2, HD3, THD vs Supply Voltage</i> figure .....	32
• Added $f_{CLK} = 3200\text{ MHz}$ to <i>Supply Current vs Temperature</i> figure .....	33
• Added $f_{CLK} = 3200\text{ MHz}$ to <i>Power Consumption vs Temperature</i> figure .....	34
• Changed <i>JMODE2</i> to <i>JMODE0</i> in <i>Background Calibration Core Transition (AC Signal)</i> figure .....	36

## 修订历史记录 (接下页)

• Changed curve data for <i>Background Calibration Core Transition (AC Signal)</i> , <i>Background Calibration Core Transition (AC Signal Zoomed)</i> , <i>Background Calibration Core Transition (DC Signal)</i> , and <i>Background Calibration Core Transition (DC Signal Zoomed)</i> figures .....	36
• Changed <i>JMODE2</i> to <i>JMODE0</i> in <i>Background Calibration Core Transition (AC Signal Zoomed)</i> figure .....	36
• 已更改 product description in <i>Overview</i> section .....	37
• 已添加 <i>Device Comparison</i> section. ....	38
• 已更改 location of <i>Analog Reference Voltage</i> section. ....	40
• 已更改 location of <i>Temperature Monitoring Diode</i> section. ....	42
• 已添加 requirement for at least 3 rising edges of SYSREF before SYSREF_POS output is valid. ....	45
• 已更改 note in <i>Basic NCO Frequency Setting Mode</i> section .....	50
• 已添加 sentence describing <i>Common NCO_RDIV Values (For 10-kHz Frequency Steps)</i> table .....	51
• 已添加 clarification of NCO synchronization using DC-coupled SYSREF.....	51
• 已添加 clarification of NCO synchronization using AC-coupled SYSREF.....	52
• 已更改 note in <i>Power-Down Modes</i> section to caution note explaining reliable serializer operation instead of the information being presented under the <i>Recommended Operating Conditions</i> table. ....	71
• 已更改 the <i>Low-Power Background Calibration (LPBG) Mode</i> section to provide additional detail of how to operate the device in low-power background calibration mode.....	77
• 已添加 clarity about offset calibration when both CAL_OS and CAL_BG are enabled. ....	78
• 已更改 <i>Trimming</i> section to limit trimming to foreground (FG) calibration mode only to better reflect customer use cases and simplify the explanation.....	79
• 已更改 additional clarity to <i>Offset Filtering</i> section to explain the frequency domain impact of the feature. ....	80
• 已更改 third sentence of SDI section to include <i>and multi-byte registers are always in little-endian format (least significant byte stored at the lowest address)</i> .....	81
• Added <i>ADC12DJ3200 Access Type Codes</i> table .....	87
• Changed description of bit 0 in <i>DEVCLK Timing Adjust Ramp Control Register</i> section .....	129
• 已添加 <i>Application Information</i> section discussion .....	132
• 已添加 <i>Reconfigurable Dual-Channel 2.5-GSPS or Single-Channel 5.0-Gsps Oscilloscope</i> section.....	135
• 已更改 <i>Top Layer Routing: Analog Inputs, CLK and SYSREF, DA0-3, DB0-3</i> to <i>Bottom Layer Routing: Additional CLK Routing, DA4-7, DB4-7</i> figures .....	142

## 5 Pin Configuration and Functions

**AAV Package  
144-Ball Flip Chip BGA  
Top View**

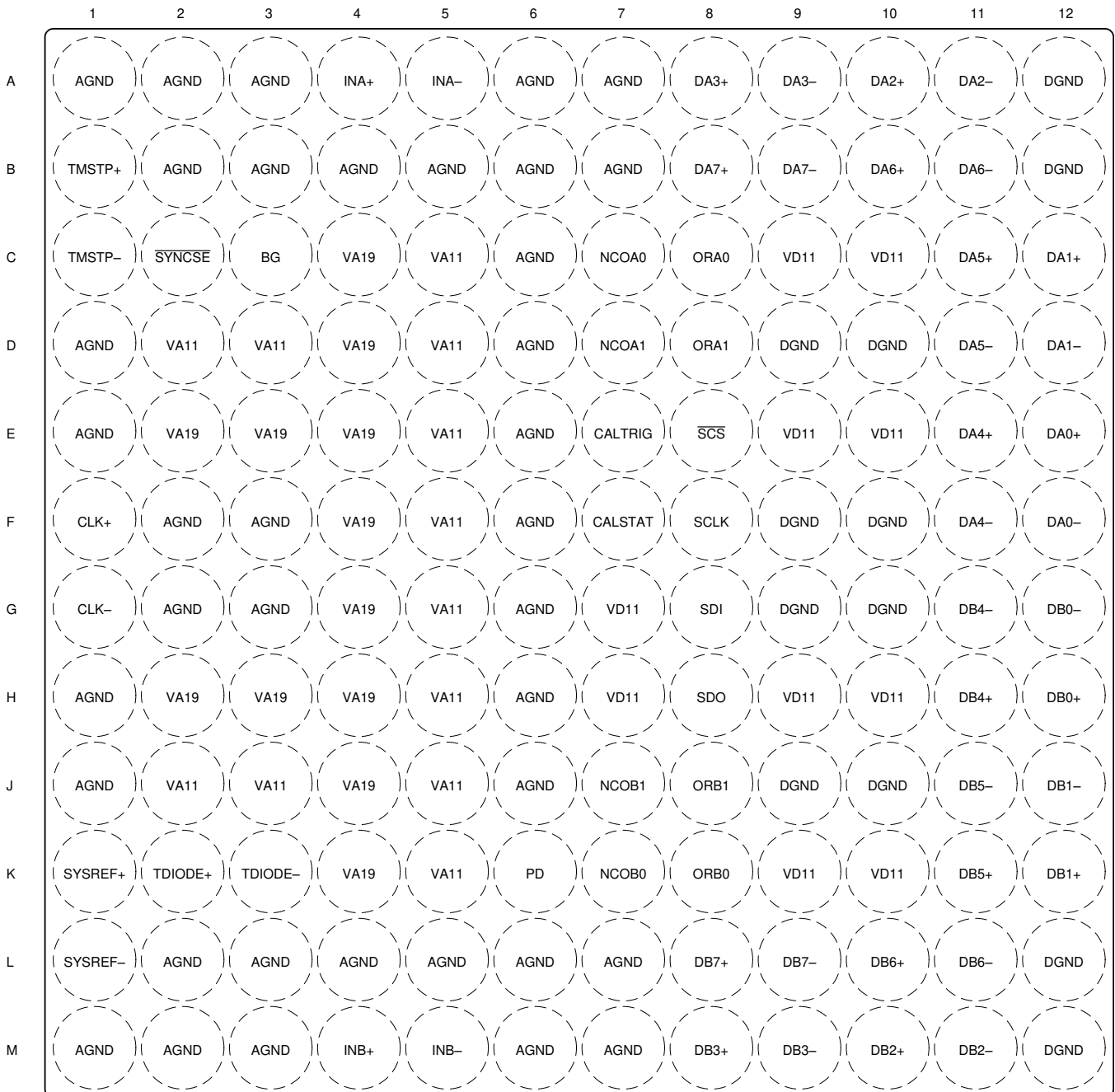

Not to scale

### Pin Functions

PIN		I/O	DESCRIPTION
NAME	NO.		
AGND	A1, A2, A3, A6, A7, B2, B3, B4, B5, B6, B7, C6, D1, D6, E1, E6, F2, F3, F6, G2, G3, G6, H1, H6, J1, J6, L2, L3, L4, L5, L6, L7, M1, M2, M3, M6, M7	—	Analog supply ground. Tie AGND and DGND to a common ground plane (GND) on the circuit board.
BG	C3	O	Band-gap voltage output. This pin is capable of sourcing only small currents and driving limited capacitive loads, as specified in the <a href="#">Recommended Operating Conditions</a> table. This pin can be left disconnected if not used.
CALSTAT	F7	O	Foreground calibration status output or device alarm output. Functionality is programmed through CAL_STATUS_SEL. This pin can be left disconnected if not used.
CALTRIG	E7	I	Foreground calibration trigger input. This pin is only used if hardware calibration triggering is selected in CAL_TRIG_EN, otherwise software triggering is performed using CAL_SOFT_TRIG. Tie this pin to GND if not used.
CLK+	F1	I	Device (sampling) clock positive input. The clock signal is strongly recommended to be AC-coupled to this input for best performance. In single-channel mode, the analog input signal is sampled on both the rising and falling edges. In dual-channel mode, the analog signal is sampled on the rising edge. This differential input has an internal untrimmed 100-Ω differential termination and is self-biased to the optimal input common-mode voltage as long as DEVCLK_LVPECL_EN is set to 0.
CLK–	G1	I	Device (sampling) clock negative input. TI strongly recommends using AC-coupling for best performance.
DA0+	E12	O	High-speed serialized data output for channel A, lane 0, positive connection. This differential output must be AC-coupled and must always be terminated with a 100-Ω differential termination at the receiver. This pin can be left disconnected if not used.
DA0–	F12	O	High-speed serialized data output for channel A, lane 0, negative connection. This pin can be left disconnected if not used.
DA1+	C12	O	High-speed serialized data output for channel A, lane 1, positive connection. This differential output must be AC-coupled and must always be terminated with a 100-Ω differential termination at the receiver. This pin can be left disconnected if not used.
DA1–	D12	O	High-speed serialized data output for channel A, lane 1, negative connection. This pin can be left disconnected if not used.
DA2+	A10	O	High-speed serialized-data output for channel A, lane 2, positive connection. This differential output must be AC-coupled and must always be terminated with a 100-Ω differential termination at the receiver. This pin can be left disconnected if not used.
DA2–	A11	O	High-speed serialized-data output for channel A, lane 2, negative connection. This pin can be left disconnected if not used.
DA3+	A8	O	High-speed serialized-data output for channel A, lane 3, positive connection. This differential output must be AC-coupled and must always be terminated with a 100-Ω differential termination at the receiver. This pin can be left disconnected if not used.
DA3–	A9	O	High-speed serialized-data output for channel A, lane 3, negative connection. This pin can be left disconnected if not used.
DA4+	E11	O	High-speed serialized data output for channel A, lane 4, positive connection. This differential output must be AC-coupled and must always be terminated with a 100-Ω differential termination at the receiver. This pin can be left disconnected if not used.
DA4–	F11	O	High-speed serialized data output for channel A, lane 4, negative connection. This pin can be left disconnected if not used.
DA5+	C11	O	High-speed serialized data output for channel A, lane 5, positive connection. This differential output must be AC-coupled and must always be terminated with a 100-Ω differential termination at the receiver. This pin can be left disconnected if not used.
DA5–	D11	O	High-speed serialized data output for channel A, lane 5, negative connection. This pin can be left disconnected if not used.

**Pin Functions (continued)**

PIN		I/O	DESCRIPTION
NAME	NO.		
DA6+	B10	O	High-speed serialized data output for channel A, lane 6, positive connection. This differential output must be AC-coupled and must always be terminated with a 100-Ω differential termination at the receiver. This pin can be left disconnected if not used.
DA6–	B11	O	High-speed serialized data output for channel A, lane 6, negative connection. This pin can be left disconnected if not used.
DA7+	B8	O	High-speed serialized data output for channel A, lane 7, positive connection. This differential output must be AC-coupled and must always be terminated with a 100-Ω differential termination at the receiver. This pin can be left disconnected if not used.
DA7–	B9	O	High-speed serialized data output for channel A, lane 7, negative connection. This pin can be left disconnected if not used.
DB0+	H12	O	High-speed serialized data output for channel B, lane 0, positive connection. This differential output must be AC-coupled and must always be terminated with a 100-Ω differential termination at the receiver. This pin can be left disconnected if not used.
DB0–	G12	O	High-speed serialized data output for channel B, lane 0, negative connection. This pin can be left disconnected if not used.
DB1+	K12	O	High-speed serialized data output for channel B, lane 1, positive connection. This differential output must be AC-coupled and must always be terminated with a 100-Ω differential termination at the receiver. This pin can be left disconnected if not used.
DB1–	J12	O	High-speed serialized data output for channel B, lane 1, negative connection. This pin can be left disconnected if not used.
DB2+	M10	O	High-speed serialized data output for channel B, lane 2, positive connection. This differential output must be AC-coupled and must always be terminated with a 100-Ω differential termination at the receiver. This pin can be left disconnected if not used.
DB2–	M11	O	High-speed serialized data output for channel B, lane 2, negative connection. This pin can be left disconnected if not used.
DB3+	M8	O	High-speed serialized data output for channel B, lane 3, positive connection. This differential output must be AC-coupled and must always be terminated with a 100-Ω differential termination at the receiver. This pin can be left disconnected if not used.
DB3–	M9	O	High-speed serialized data output for channel B, lane 3, negative connection. This pin can be left disconnected if not used.
DB4+	H11	O	High-speed serialized data output for channel B, lane 4, positive connection. This differential output must be AC-coupled and must always be terminated with a 100-Ω differential termination at the receiver. This pin can be left disconnected if not used.
DB4–	G11	O	High-speed serialized data output for channel B, lane 4, negative connection. This pin can be left disconnected if not used.
DB5+	K11	O	High-speed serialized data output for channel B, lane 5, positive connection. This differential output must be AC-coupled and must always be terminated with a 100-Ω differential termination at the receiver. This pin can be left disconnected if not used.
DB5–	J11	O	High-speed serialized data output for channel B, lane 5, negative connection. This pin can be left disconnected if not used.
DB6+	L10	O	High-speed serialized data output for channel B, lane 6, positive connection. This differential output must be AC-coupled and must always be terminated with a 100-Ω differential termination at the receiver. This pin can be left disconnected if not used.
DB6–	L11	O	High-speed serialized data output for channel B, lane 6, negative connection. This pin can be left disconnected if not used.
DB7+	L8	O	High-speed serialized data output for channel B, lane 7, positive connection. This differential output must be AC-coupled and must always be terminated with a 100-Ω differential termination at the receiver. This pin can be left disconnected if not used.
DB7–	L9	O	High-speed serialized data output for channel B, lane 7, negative connection. This pin can be left disconnected if not used.
DGND	A12, B12, D9, D10, F9, F10, G9, G10, J9, J10, L12, M12	—	Digital supply ground. Tie AGND and DGND to a common ground plane (GND) on the circuit board.



**Pin Functions (continued)**

PIN		I/O	DESCRIPTION
NAME	NO.		
INA+	A4	I	Channel A analog input positive connection. INA± is recommended for use in single channel mode for optimal performance. The differential full-scale input voltage is determined by the FS_RANGE_A register (see the <a href="#">Full-Scale Voltage (VFS) Adjustment</a> section). This input is terminated to ground through a 50-Ω termination resistor. The input common-mode voltage is typically be set to 0 V (GND) and must follow the recommendations in the <a href="#">Recommended Operating Conditions</a> table. This pin can be left disconnected if not used.
INA–	A5	I	Channel A analog input negative connection. INA± is recommended for use in single channel mode for optimal performance. See INA+ (pin A4) for detailed description. This input is terminated to ground through a 50-Ω termination resistor. This pin can be left disconnected if not used.
INB+	M4	I	Channel B analog input positive connection. INA± is recommended for use in single channel mode for optimal performance. The differential full-scale input voltage is determined by the FS_RANGE_B register (see the <a href="#">Full-Scale Voltage (VFS) Adjustment</a> section). This input is terminated to ground through a 50-Ω termination resistor. The input common-mode voltage is typically be set to 0 V (GND) and must follow the recommendations in the <a href="#">Recommended Operating Conditions</a> table. This pin can be left disconnected if not used.
INB–	M5	I	Channel B analog input negative connection. INA± is recommended for use in single channel mode for optimal performance. See INA+ (pin A4) for detailed description. This input is terminated to ground through a 50-Ω termination resistor. This pin can be left disconnected if not used.
NCOA0	C7	I	LSB of NCO selection control for DDC A. NCOA0 and NCOA1 select which NCO, of a possible four NCOs, is used for digital mixing when using a complex output JMODE. The remaining unselected NCOs continue to run to maintain phase coherency and can be swapped in by changing the values of NCOA0 and NCOA1 (when CMODE = 1). This pin is an asynchronous input. See the <a href="#">NCO Fast Frequency Hopping (FFH)</a> and <a href="#">NCO Selection</a> sections for more information. Tie this pin to GND if not used.
NCOA1	D7	I	MSB of NCO selection control for DDC A. Tie this pin to GND if not used.
NCOB0	K7	I	LSB of NCO selection control for DDC B. NCOB0 and NCOB1 select which NCO, of a possible four NCOs, is used for digital mixing when using a complex output JMODE. The remaining unselected NCOs continue to run to maintain phase coherency and can be swapped in by changing the values of NCOB0 and NCOB1 (when CMODE = 1). This pin is an asynchronous input. See the <a href="#">NCO Fast Frequency Hopping (FFH)</a> and <a href="#">NCO Selection</a> sections for more information. Tie this pin to GND if not used.
NCOB1	J7	I	MSB of NCO selection control for DDC B. Tie this pin to GND if not used.
ORA0	C8	O	Fast overrange detection status for channel A for the OVR_T0 threshold. When the analog input exceeds the threshold programmed into OVR_T0, this status indicator goes high. The minimum pulse duration is set by OVR_N. See the <a href="#">ADC Overage Detection</a> section for more information. This pin can be left disconnected if not used.
ORA1	D8	O	Fast overrange detection status for channel A for the OVR_T1 threshold. When the analog input exceeds the threshold programmed into OVR_T1, this status indicator goes high. The minimum pulse duration is set by OVR_N. See the <a href="#">ADC Overage Detection</a> section for more information. This pin can be left disconnected if not used.
ORB0	K8	O	Fast overrange detection status for channel B for the OVR_T0 threshold. When the analog input exceeds the threshold programmed into OVR_T0, this status indicator goes high. The minimum pulse duration is set by OVR_N. See the <a href="#">ADC Overage Detection</a> section for more information. This pin can be left disconnected if not used.
ORB1	J8	O	Fast overrange detection status for channel B for the OVR_T1 threshold. When the analog input exceeds the threshold programmed into OVR_T1, this status indicator goes high. The minimum pulse duration is set by OVR_N. See the <a href="#">ADC Overage Detection</a> section for more information. This pin can be left disconnected if not used.
PD	K6	I	This pin disables all analog circuits and serializer outputs when set high for temperature diode calibration only. Do not use this pin to power down the device for power savings. Tie this pin to GND during normal operation. For information regarding reliable serializer operation, see the <a href="#">Power-Down Modes</a> section.
SCLK	F8	I	Serial interface clock. This pin functions as the serial-interface clock input that clocks the serial programming data in and out. The <a href="#">Using the Serial Interface</a> section describes the serial interface in more detail. Supports 1.1-V to 1.9-V CMOS levels.
$\overline{\text{SCS}}$	E8	I	Serial interface chip select active low input. The <a href="#">Using the Serial Interface</a> section describes the serial interface in more detail. Supports 1.1-V to 1.9-V CMOS levels. This pin has a 82-kΩ pullup resistor to VD11.
SDI	G8	I	Serial interface data input. The <a href="#">Using the Serial Interface</a> section describes the serial interface in more detail. Supports 1.1-V to 1.9-V CMOS levels.

**Pin Functions (continued)**

PIN		I/O	DESCRIPTION
NAME	NO.		
SDO	H8	O	Serial interface data output. The <a href="#">Using the Serial Interface</a> section describes the serial interface in more detail. This pin is high impedance during normal device operation. This pin outputs 1.9-V CMOS levels during serial interface read operations. This pin can be left disconnected if not used.
$\overline{\text{SYNCSE}}$	C2	I	Single-ended JESD204B SYNC signal. This input is an active low input that is used to initialize the JESD204C serial link in 8B/10B modes when SYNC_SEL is set to 0. When toggled low this input initiates code group synchronization (see the <a href="#">Code Group Synchronization (CGS)</a> section). After code group synchronization, this input must be toggled high to start the initial lane alignment sequence (see the <a href="#">Initial Lane Alignment Sequence (ILAS)</a> section). A differential SYNC signal can be used instead by setting SYNC_SEL to 1 and using TMSTP± as a differential SYNC input. Tie this pin to GND if differential SYNC (TMSTP±) is used as the JESD204B SYNC signal.
SYSREF+	K1	I	The SYSREF positive input is used to achieve synchronization and deterministic latency across the JESD204B interface. This differential input (SYSREF+ to SYSREF−) has an internal untrimmed 100-Ω differential termination and can be AC-coupled when SYSREF_LVPECL_EN is set to 0. This input is self-biased when SYSREF_LVPECL_EN is set to 0. The termination changes to 50 Ω to ground on each input pin (SYSREF+ and SYSREF−) and can be DC-coupled when SYSREF_LVPECL_EN is set to 1. This input is not self-biased when SYSREF_LVPECL_EN is set to 1 and must be biased externally to the input common-mode voltage range provided in the <a href="#">Recommended Operating Conditions</a> table.
SYSREF−	L1	I	SYSREF negative input
TDIODE+	K2	I	Temperature diode positive (anode) connection. An external temperature sensor can be connected to TDIODE+ and TDIODE− to monitor the junction temperature of the device. This pin can be left disconnected if not used.
TDIODE−	K3	I	Temperature diode negative (cathode) connection. This pin can be left disconnected if not used.
TMSTP+	B1	I	Timestamp input positive connection or differential JESD204B $\overline{\text{SYNC}}$ positive connection. This input is a timestamp input, used to mark a specific sample, when TIMESTAMP_EN is set to 1. This differential input is used as the JESD204B SYNC signal input when SYNC_SEL is set 1. This input can be used as both a timestamp and differential SYNC input at the same time, allowing feedback of the SYNC signal using the timestamp mechanism. TMSTP± uses active low signaling when used as a JESD204B SYNC. For additional usage information, see the <a href="#">Timestamp</a> section. TMSTP_RECV_EN must be set to 1 to use this input. This differential input (TMSTP+ to TMSTP−) has an internal untrimmed 100-Ω differential termination and can be AC-coupled when TMSTP_LVPECL_EN is set to 0. The termination changes to 50 Ω to ground on each input pin (TMSTP+ and TMSTP−) and can be DC coupled when TMSTP_LVPECL_EN is set to 1. This pin is not self-biased and therefore must be externally biased for both AC- and DC-coupled configurations. The common-mode voltage must be within the range provided in the <a href="#">Recommended Operating Conditions</a> table when both AC and DC coupled. This pin can be left disconnected and disabled (TMSTP_RECV_EN = 0) if $\overline{\text{SYNCSE}}$ is used for JESD204B SYNC and timestamp is not required.
TMSTP−	C1	I	Timestamp input positive connection or differential JESD204B $\overline{\text{SYNC}}$ negative connection. This pin can be left disconnected and disabled (TMSTP_RECV_EN = 0) if $\overline{\text{SYNCSE}}$ is used for JESD204B SYNC and timestamp is not required.
VA11	C5, D2, D3, D5, E5, F5, G5, H5, J2, J3, J5, K5	I	1.1-V analog supply
VA19	C4, D4, E2, E3, E4, F4, G4, H2, H3, H4, J4, K4	I	1.9-V analog supply
VD11	C9, C10, E9, E10, G7, H7, H9, H10, K9, K10	I	1.1-V digital supply



## 6 Specifications

### 6.1 Absolute Maximum Ratings

Over operating free-air temperature range (unless otherwise noted)<sup>(1)</sup>

		MIN	MAX	UNIT
Supply Voltage Range	VA19 <sup>(2)</sup>	-0.3	2.35	V
	VA11 <sup>(2)</sup>	-0.3	1.32	V
	VD11 <sup>(3)</sup>	-0.3	1.32	V
	Voltage between VD11 and VA11	-1.32	1.32	V
Voltage between AGND and DGND		-0.1	0.1	V
Terminal Voltage Range	DA0...7+, DA0...7-, DB0...7+, DB0...7-, TMSTP+, TMSTP- <sup>(3)</sup>	-0.5	min(1.32, VD11+0.5)	V
	CLK+, CLK-, SYSREF+, SYSREF- <sup>(2)</sup>	-0.5	min(1.32, VA11+0.5)	V
	BG, TDIODE+, TDIODE- <sup>(2)</sup>	-0.5	min(2.35, VA19+0.5)	V
	INA+, INA-, INB+, INB- <sup>(2)</sup>	-1	1	V
	CALSTAT, CALTRIG, NCOA0, NCOA1, NCOB0, NCOB1, ORA0, ORA1, ORB0, ORB1, PD, SCLK, SCS, SDI, SDO, SYNCSE <sup>(2)</sup>	-0.5	VA19+0.5	V
Peak input current (any input except INA+, INA-, INB+, INB-)		-25	25	mA
Peak input current (INA+, INA-, INB+, INB-)		-50	50	mA
Peak RF input power (INA+, INA-, INB+, INB-)	Single-ended with $Z_{S-SE} = 50 \Omega$ or differential with $Z_{S-DIFF} = 100 \Omega$		16.4	dBm
Peak total input current (sum of absolute value of all currents forced in or out, not including power supply current)			100	mA
Operating junction temperature, $T_j$			150	°C
Storage temperature, $T_{stg}$		-65	150	°C

(1) Stresses beyond those listed under *Absolute Maximum Ratings* may cause permanent damage to the device. These are stress ratings only, which do not imply functional operation of the device at these or any other conditions beyond those indicated under *Recommended Operating Conditions*. Exposure to absolute-maximum-rated conditions for extended periods may affect device reliability.

(2) Measured to AGND.

(3) Measured to DGND.

### 6.2 ESD Ratings

		VALUE	UNIT
$V_{(ESD)}$ Electrostatic discharge	Human-body model (HBM), per ANSI/ESDA/JEDEC JS-001 <sup>(1)</sup>	± 2500	V
	Charged-device model (CDM), per JEDEC specification JESD22-C101 <sup>(2)</sup>	± 1000	

(1) JEDEC document JEP155 states that 500-V HBM allows safe manufacturing with a standard ESD control process.

(2) JEDEC document JEP157 states that 250-V CDM allows safe manufacturing with a standard ESD control process.

### 6.3 Recommended Operating Conditions

Over operating free-air temperature range (unless otherwise noted)

		MIN	NOM	MAX	UNIT	
V <sub>DD</sub>	Supply Voltage Range	VA19, Analog 1.9V supply <sup>(1)</sup>	1.8	1.9	2.0	V
		VA11, Analog 1.1V supply <sup>(1)</sup>	1.05	1.1	1.15	V
		VD11, Digital 1.1V supply <sup>(2)</sup>	1.05	1.1	1.15	V
V <sub>CM1</sub>	Input common mode voltage	INA+, INA–, INB+, INB– <sup>(1)</sup>	-50	0	100	mV
		CLK+, CLK–, SYSREF+, SYSREF– <sup>(1)(3)</sup>	0.0	0.3	0.55	V
		TMSTP+, TMSTP– <sup>(1)(4)</sup>	0.0	0.3	0.55	V
V <sub>ID</sub>	Input voltage, peak-to-peak differential	CLK+ to CLK–, SYSREF+ to SYSREF–, TMSTP+ to TMSTP–	0.4	1.0	2.0	V <sub>PP-DIFF</sub>
		INA+ to INA–, INB+ to INB–			1.0 <sup>(5)</sup>	V <sub>PP-DIFF</sub>
V <sub>IH</sub>	High level input voltage	CALTRIG, NCOA0, NCOA1, NCOB0, NCOB1, PD, SCLK, SCS, SDI, SYNCSE <sup>(1)</sup>	0.7			V
V <sub>IL</sub>	Low level input voltage	CALTRIG, NCOA0, NCOA1, NCOB0, NCOB1, PD, SCLK, SCS, SDI, SYNCSE <sup>(1)</sup>		0.45		V
I <sub>C_TD</sub>	Temperature diode input current	TDIODE+ to TDIODE–		100		μA
C <sub>L</sub>	BG max load capacitance			50		pF
I <sub>O</sub>	BG max output current			100		μA
DC	Input clock duty cycle		30	50	70	%
T <sub>A</sub>	Operating free-air temperature		-40		85	°C
T <sub>j</sub>	Operating junction temperature				105 <sup>(6)(7)</sup>	°C

(1) Measured to AGND.

(2) Measured to DGND.

(3) It is strongly recommended that CLK+/- be AC coupled with DEVCLK\_LVPECL\_EN set to 0 to allow CLK+/- to self bias to the optimal input common mode voltage for best performance. TI recommends AC coupling for SYSREF+/- unless DC coupling is required, in which case LVPECL input mode must be used (SYSREF\_LVPECL\_EN = 1).

(4) TMSTP+/- does not have internal biasing which requires TMSTP+/- to be biased externally whether AC coupled with TMSTP\_LVPECL\_EN = 0 or DC coupled with TMSTP\_LVPECL\_EN = 1.

 (5) ADC output code will saturate when V<sub>ID</sub> for INA+/- or INB+/- exceeds the programmed full-scale voltage (V<sub>FS</sub>) set by FS\_RANGE\_A for INA+/- or FS\_RANGE\_B for INB+/- .

(6) Prolonged use above this junction temperature may increase the device failure-in-time (FIT) rate.

 (7) Tested up to 1000 hours continuous operation at T<sub>j</sub> = 125°C. See [Absolute Maximum Ratings](#) for absolute maximum operational temperature.

### 6.4 Thermal Information

THERMAL METRIC <sup>(1)</sup>		ADC12DJ3200	UNIT
		AAV (FCBGA)	
		144 PINS	
R <sub>θJA</sub>	Junction-to-ambient thermal resistance	25.3	°C/W
R <sub>θJC(top)</sub>	Junction-to-case (top) thermal resistance	1.1	°C/W
R <sub>θJB</sub>	Junction-to-board thermal resistance	8.2	°C/W
ψ <sub>JT</sub>	Junction-to-top characterization parameter	0.1	°C/W
ψ <sub>JB</sub>	Junction-to-board characterization parameter	8.2	°C/W
R <sub>θJC(bot)</sub>	Junction-to-case (bottom) thermal resistance	n/a	°C/W

 (1) For more information about traditional and new thermal metrics, see the [Semiconductor and IC Package Thermal Metrics](#) application report.

## 6.5 Electrical Characteristics - DC Specifications

Typical values at  $T_A = +25^\circ\text{C}$ ,  $V_{A19} = 1.9\text{V}$ ,  $V_{A11} = 1.1\text{V}$ ,  $V_{D11} = 1.1\text{V}$ , default full-scale voltage ( $\text{FS\_RANGE\_A} = \text{FS\_RANGE\_B} = 0\text{x}A000$ ), input signal applied to  $\text{INA+/-}$  in single channel modes,  $f_{\text{IN}} = 248\text{ MHz}$ ,  $A_{\text{IN}} = -1\text{ dBFS}$ ,  $f_{\text{CLK}} =$  maximum rated clock frequency, filtered 1-Vpp sine-wave clock,  $\text{JMODE} = 1$ , background calibration, unless otherwise noted. Minimum and maximum values are at nominal supply voltages and over operating free-air temperature range provided in [Recommended Operating Conditions](#).

PARAMETER		TEST CONDITIONS	MIN	TYP	MAX	UNIT
<b>DC ACCURACY</b>						
Resolution		Resolution with no missing codes		12		bits
DNL	Differential nonlinearity			$\pm 0.3$		LSB
INL	Integral nonlinearity			$\pm 2.5$		LSB
<b>ANALOG INPUTS (INA+, INA-, INB+, INB-)</b>						
$V_{\text{OFF}}$	Offset Error	Default full-scale voltage, OS_CAL disabled		$\pm 0.6$		mV
$V_{\text{OFF\_ADJ}}$	Input offset voltage adjustment range	Available offset correction range (see OS_CAL or OADJ_x_INx)		$\pm 55$		mV
$V_{\text{OFF\_DRIFT}}$	Offset Drift	Foreground calibration at nominal temperature only		23		$\mu\text{V}/^\circ\text{C}$
		Foreground calibration at each temperature		0		$\mu\text{V}/^\circ\text{C}$
$V_{\text{IN\_FSR}}$	Analog differential input full scale range	Default full-scale voltage ( $\text{FS\_RANGE\_A} = \text{FS\_RANGE\_B} = 0\text{x}A000$ )	750	800	850	mV <sub>PP</sub>
		Maximum full-scale voltage ( $\text{FS\_RANGE\_A} = \text{FS\_RANGE\_B} = 0\text{x}FFFF$ )	1000	1040		mV <sub>PP</sub>
		Minimum full-scale voltage ( $\text{FS\_RANGE\_A} = \text{FS\_RANGE\_B} = 0\text{x}2000$ )		480	500	mV <sub>PP</sub>
$V_{\text{IN\_FSR\_DRIFT}}$	Analog differential input full scale range drift	Default FS_RANGE_A and FS_RANGE_B setting, foreground calibration at nominal temperature only, inputs driven by 50- $\Omega$ source, includes effect of $R_{\text{IN}}$ drift		-0.01		$\%/^\circ\text{C}$
		Default FS_RANGE_A and FS_RANGE_B setting, foreground calibration at each temperature, inputs driven by 50- $\Omega$ source, includes effect of $R_{\text{IN}}$ drift		0.03		$\%/^\circ\text{C}$
$V_{\text{IN\_FSR\_MATCH}}$	Analog differential input full scale range matching	Matching between $\text{INA+}/\text{INA-}$ and $\text{INB+}/\text{INB-}$ , default setting, dual channel mode		0.625		%
$R_{\text{IN}}$	Single-ended input resistance to AGND	Each input terminal is terminated to AGND, measured at $T_A = 25^\circ\text{C}$	48	50	52	$\Omega$
$R_{\text{IN\_TEMPCO}}$	Input termination linear temperature coefficient			17.6		$\text{m}\Omega/^\circ\text{C}$
$C_{\text{IN}}$	Single-ended input capacitance	Single channel mode at DC		0.4		pF
		Dual channel mode at DC		0.4		pF
<b>TEMPERATURE DIODE CHARACTERISTICS (TDIODE+, TDIODE-)</b>						
$\Delta V_{\text{BE}}$	Temperature diode voltage slope	Forced forward current of 100 $\mu\text{A}$ . Offset voltage (approx. 0.792 V at $0^\circ\text{C}$ ) varies with process and must be measured for each part. Offset measurement should be done with the device unpowered or with the PD pin asserted to minimize device self-heating. PD pin should be asserted only long enough to take the offset measurement.		-1.6		$\text{mV}/^\circ\text{C}$
<b>BANDGAP VOLTAGE OUTPUT (BG)</b>						
$V_{\text{BG}}$	Reference output voltage	$I_L \leq 100\ \mu\text{A}$		1.1		V
$V_{\text{BG\_DRIFT}}$	Reference output temperature drift	$I_L \leq 100\ \mu\text{A}$		-64		$\mu\text{V}/^\circ\text{C}$

**Electrical Characteristics - DC Specifications (continued)**

Typical values at  $T_A = +25^\circ\text{C}$ ,  $V_{A19} = 1.9\text{V}$ ,  $V_{A11} = 1.1\text{V}$ ,  $V_{D11} = 1.1\text{V}$ , default full-scale voltage (FS\_RANGE\_A = FS\_RANGE\_B = 0xA000), input signal applied to INA+/- in single channel modes,  $f_{IN} = 248\text{ MHz}$ ,  $A_{IN} = -1\text{ dBFS}$ ,  $f_{CLK} =$  maximum rated clock frequency, filtered 1-Vpp sine-wave clock, JMODE = 1, background calibration, unless otherwise noted. Minimum and maximum values are at nominal supply voltages and over operating free-air temperature range provided in [Recommended Operating Conditions](#).

PARAMETER	TEST CONDITIONS	MIN	TYP	MAX	UNIT	
<b>CLOCK INPUTS (CLK+, CLK-, SYSREF+, SYSREF-, TMSTP+, TMSTP-)</b>						
$Z_T$	Internal termination	Differential termination with DEVCLK_LVPECL_EN = 0, SYSREF_LVPECL_EN = 0 and TMSTP_LVPECL_EN = 0		110		$\Omega$
		Single ended termination to GND (per pin) with DEVCLK_LVPECL_EN = 0, SYSREF_LVPECL_EN = 0 and TMSTP_LVPECL_EN = 0		55		$\Omega$
$V_{CM}$	Input common mode voltage, self-biased	Self-biasing common mode voltage for CLK+/- when AC coupled (DEVCLK_LVPECL_EN must be set to 0)		0.26		V
		Self-biasing common mode voltage for SYSREF+/- when AC coupled (SYSREF_LVPECL_EN must be set to 0) and with receiver enabled (SYSREF_RECV_EN = 1).		0.29		V
		Self-biasing common mode voltage for SYSREF+/- when AC coupled (SYSREF_LVPECL_EN must be set to 0) and with receiver disabled (SYSREF_RECV_EN = 0).		$V_{A11}$		V
$C_{L\_DIFF}$	Differential input capacitance	Between positive and negative differential input pins		0.1		pF
$C_{L\_SE}$	Single-ended input capacitance	Each input to ground		0.5		pF
<b>SERDES OUTPUTS (DA0+/DA0-...DA7+/DA7-, DB0+/DB0-...DB7+/DB7-)</b>						
$V_{OD}$	Differential output voltage, peak-to-peak	100- $\Omega$ load	550	600	650	mV <sub>PP-DIFF</sub>
$V_{CM}$	Output common mode voltage	AC coupled		$V_{D11/2}$		V
$Z_{DIFF}$	Differential output impedance			100		$\Omega$
<b>CMOS INTERFACE: SCLK, SDI, SDO, <math>\overline{SCS}</math>, PD, NCOA0, NCOA1, NCOB0, NCOB1, CALSTAT, CALTRIG, ORA0, ORA1, ORB0, ORB1, SYNCSE</b>						
$I_{IH}$	High level input current		-40		40	$\mu\text{A}$
$I_{IL}$	Low level input current		-40		40	$\mu\text{A}$
$C_I$	Input capacitance			2		pF
$V_{OH}$	High level output voltage	$I_{LOAD} = -400\ \mu\text{A}$	1.65			V
$V_{OL}$	Low level output voltage	$I_{LOAD} = 400\ \mu\text{A}$			150	mV

## 6.6 Electrical Characteristics - Power Consumption

Typical values at  $T_A = +25^\circ\text{C}$ ,  $V_{A19} = 1.9\text{V}$ ,  $V_{A11} = 1.1\text{V}$ ,  $V_{D11} = 1.1\text{V}$ , default full-scale voltage ( $\text{FS\_RANGE\_A} = \text{FS\_RANGE\_B} = 0xA000$ ), input signal applied to  $\text{INA}+/-$  in single channel modes,  $f_{\text{IN}} = 248\text{ MHz}$ ,  $A_{\text{IN}} = -1\text{ dBFS}$ ,  $f_{\text{CLK}} =$  maximum rated clock frequency, filtered 1-Vpp sine-wave clock,  $\text{JMODE} = 1$ , background calibration, unless otherwise noted. Minimum and maximum values are at nominal supply voltages and over operating free-air temperature range provided in [Recommended Operating Conditions](#).

PARAMETER		TEST CONDITIONS	MIN	TYP	MAX	UNIT
$I_{VA19}$	1.9-V analog supply current	Power mode 1: Single channel mode, JMODE 1 (16 lanes, DDC bypassed), foreground calibration		897		mA
$I_{VA11}$	1.1-V analog supply current			491		mA
$I_{VD11}$	1.1-V digital supply current			640		mA
$P_{\text{DIS}}$	Power dissipation			3.0		W
$I_{VA19}$	1.9-V analog supply current	Power mode 2: Single channel mode, JMODE 0 (8 lanes, DDC bypassed), foreground calibration		875	950	mA
$I_{VA11}$	1.1-V analog supply current			515	600	mA
$I_{VD11}$	1.1-V digital supply current			615	750	mA
$P_{\text{DIS}}$	Power dissipation			2.9	3.5	W
$I_{VA19}$	1.9-V analog supply current	Power mode 3: Single channel mode, JMODE 1 (16 lanes, DDC bypassed), background calibration		1181		mA
$I_{VA11}$	1.1-V analog supply current			595		mA
$I_{VD11}$	1.1-V digital supply current			653		mA
$P_{\text{DIS}}$	Power dissipation			3.6		W
$I_{VA19}$	1.9-V analog supply current	Power mode 4: Dual channel mode, JMODE 3 (16 lanes, DDC bypassed), background calibration		1260		mA
$I_{VA11}$	1.1-V analog supply current			594		mA
$I_{VD11}$	1.1-V digital supply current			636		mA
$P_{\text{DIS}}$	Power dissipation			3.8		W
$I_{VA19}$	1.9-V analog supply current	Power mode 5: Dual channel mode, JMODE 11 (8 lanes, 4x decimation), foreground calibration		964		mA
$I_{VA11}$	1.1-V analog supply current			493		mA
$I_{VD11}$	1.1-V digital supply current			802		mA
$P_{\text{DIS}}$	Power dissipation			3.3		W

## 6.7 Electrical Characteristics: AC Specifications (Dual-Channel Mode)

Typical values at  $T_A = +25^\circ\text{C}$ ,  $V_{A19} = 1.9\text{V}$ ,  $V_{A11} = 1.1\text{V}$ ,  $V_{D11} = 1.1\text{V}$ , default full-scale voltage ( $\text{FS\_RANGE\_A} = \text{FS\_RANGE\_B} = 0xA000$ ),  $f_{\text{IN}} = 248\text{ MHz}$ ,  $A_{\text{IN}} = -1\text{ dBFS}$ ,  $f_{\text{CLK}} =$  maximum rated clock frequency, filtered 1- $V_{\text{PP}}$  sine-wave clock,  $\text{JMODE} = 3$  and background calibration (unless otherwise noted); minimum and maximum values are at nominal supply voltages and over operating free-air temperature range provided in the [Recommended Operating Conditions](#) table.

PARAMETER		TEST CONDITIONS	MIN	TYP	MAX	UNIT
FPBW	Full-power input bandwidth (-3 dB) <sup>(1)</sup>	Foreground calibration		8.1		GHz
		Background calibration		8.1		
XTALK	Channel-to-channel Crosstalk	Aggressor = 400 MHz, -1 dBFS		-93		dB
		Aggressor = 3 GHz, -1 dBFS		-70		
		Aggressor = 6 GHz, -1 dBFS		-63		
CER	Code error rate			$10^{-18}$		errors/sample
NOISE <sub>DC</sub>	DC input noise standard deviation	No input, foreground calibration, excludes DC offset, includes fixed interleaving spur ( $F_s/2$ spur)		2		LSB
NSD	Noise spectral density, no input signal, excludes fixed interleaving spur ( $F_s/2$ spur)	Maximum full-scale voltage ( $\text{FS\_RANGE\_A} = \text{FS\_RANGE\_B} = 0xFFFF$ ) setting, foreground calibration		-151.8		dBFS/Hz
		Default full-scale voltage ( $\text{FS\_RANGE\_A} = \text{FS\_RANGE\_B} = 0xA000$ ) setting, foreground calibration		-150.2		
NF	Noise figure, no input, $Z_S = 100\ \Omega$	Maximum full-scale voltage ( $\text{FS\_RANGE\_A} = 0xFFFF$ ) setting, foreground calibration		23.5		dB
		Default full-scale voltage ( $\text{FS\_RANGE\_A} = 0xA000$ ) setting, foreground calibration		22.8		
SNR	Signal to noise ratio, large signal, excluding DC, HD2 to HD9 and interleaving spurs	$f_{\text{IN}} = 347\text{ MHz}$ , $A_{\text{IN}} = -1\text{ dBFS}$		56.6		dBFS
		$f_{\text{IN}} = 347\text{ MHz}$ , $A_{\text{IN}} = -1\text{ dBFS}$ , maximum $\text{FS\_RANGE\_A}$ and $\text{FS\_RANGE\_B}$ setting, foreground calibration		57.6		
		$f_{\text{IN}} = 997\text{ MHz}$ , $A_{\text{IN}} = -1\text{ dBFS}$		56.3		
		$f_{\text{IN}} = 2482\text{ MHz}$ , $A_{\text{IN}} = -1\text{ dBFS}$	52	55.2		
		$f_{\text{IN}} = 2482\text{ MHz}$ , $A_{\text{IN}} = -1\text{ dBFS}$ , maximum $\text{FS\_RANGE\_A}$ and $\text{FS\_RANGE\_B}$ setting, foreground calibration		56.1		
		$f_{\text{IN}} = 4997\text{ MHz}$ , $A_{\text{IN}} = -1\text{ dBFS}$		52.6		
		$f_{\text{IN}} = 6397\text{ MHz}$ , $A_{\text{IN}} = -1\text{ dBFS}$		51.3		
SNR	Signal to noise ratio, small signal, excluding DC, HD2 to HD9 and interleaving spurs	$f_{\text{IN}} = 347\text{ MHz}$ , $A_{\text{IN}} = -16\text{ dBFS}$		57.4		dBFS
		$f_{\text{IN}} = 997\text{ MHz}$ , $A_{\text{IN}} = -16\text{ dBFS}$		57.5		
		$f_{\text{IN}} = 2482\text{ MHz}$ , $A_{\text{IN}} = -16\text{ dBFS}$		57.4		
		$f_{\text{IN}} = 4997\text{ MHz}$ , $A_{\text{IN}} = -16\text{ dBFS}$		57.1		
		$f_{\text{IN}} = 6397\text{ MHz}$ , $A_{\text{IN}} = -16\text{ dBFS}$		57.3		
		$f_{\text{IN}} = 8197\text{ MHz}$ , $A_{\text{IN}} = -16\text{ dBFS}$		56.9		

(1) Full-power input bandwidth (FPBW) is defined as the input frequency where the reconstructed output of the ADC has dropped 3 dB below the power of a full-scale input signal at a low input frequency. Useable bandwidth may exceed the -3-dB full-power input bandwidth.



**Electrical Characteristics: AC Specifications (Dual-Channel Mode) (continued)**

Typical values at  $T_A = +25^\circ\text{C}$ ,  $V_{A19} = 1.9\text{V}$ ,  $V_{A11} = 1.1\text{V}$ ,  $V_{D11} = 1.1\text{V}$ , default full-scale voltage ( $\text{FS\_RANGE\_A} = \text{FS\_RANGE\_B} = 0xA000$ ),  $f_{\text{IN}} = 248\text{ MHz}$ ,  $A_{\text{IN}} = -1\text{ dBFS}$ ,  $f_{\text{CLK}} =$  maximum rated clock frequency, filtered  $1\text{-}V_{\text{PP}}$  sine-wave clock,  $\text{JMODE} = 3$  and background calibration (unless otherwise noted); minimum and maximum values are at nominal supply voltages and over operating free-air temperature range provided in the [Recommended Operating Conditions](#) table.

PARAMETER		TEST CONDITIONS	MIN	TYP	MAX	UNIT
SINAD	Signal to noise and distortion ratio, large signal, excluding DC and $F_S/2$ fixed spurs	$f_{\text{IN}} = 347\text{ MHz}$ , $A_{\text{IN}} = -1\text{ dBFS}$		56.0		dBFS
		$f_{\text{IN}} = 997\text{ MHz}$ , $A_{\text{IN}} = -1\text{ dBFS}$		55.7		
		$f_{\text{IN}} = 2482\text{ MHz}$ , $A_{\text{IN}} = -1\text{ dBFS}$	51	54.6		
		$f_{\text{IN}} = 4997\text{ MHz}$ , $A_{\text{IN}} = -1\text{ dBFS}$		50.3		
		$f_{\text{IN}} = 6397\text{ MHz}$ , $A_{\text{IN}} = -1\text{ dBFS}$		48.9		
		$f_{\text{IN}} = 8197\text{ MHz}$ , $A_{\text{IN}} = -1\text{ dBFS}$		47.4		
ENOB	Effective number of bits, large signal, excluding DC and $F_S/2$ fixed spurs	$f_{\text{IN}} = 347\text{ MHz}$ , $A_{\text{IN}} = -1\text{ dBFS}$		9.0		bits
		$f_{\text{IN}} = 997\text{ MHz}$ , $A_{\text{IN}} = -1\text{ dBFS}$		9.0		
		$f_{\text{IN}} = 2482\text{ MHz}$ , $A_{\text{IN}} = -1\text{ dBFS}$	8.2	8.8		
		$f_{\text{IN}} = 4997\text{ MHz}$ , $A_{\text{IN}} = -1\text{ dBFS}$		8.1		
		$f_{\text{IN}} = 6397\text{ MHz}$ , $A_{\text{IN}} = -1\text{ dBFS}$		7.8		
		$f_{\text{IN}} = 8197\text{ MHz}$ , $A_{\text{IN}} = -1\text{ dBFS}$		7.6		
SFDR	Spurious free dynamic range, large signal, excluding DC and $F_S/2$ fixed spurs	$f_{\text{IN}} = 347\text{ MHz}$ , $A_{\text{IN}} = -1\text{ dBFS}$		67		dBFS
		$f_{\text{IN}} = 347\text{ MHz}$ , $A_{\text{IN}} = -1\text{ dBFS}$ , maximum $\text{FS\_RANGE\_A}$ and $\text{FS\_RANGE\_B}$ setting, foreground calibration		67		
		$f_{\text{IN}} = 997\text{ MHz}$ , $A_{\text{IN}} = -1\text{ dBFS}$		69		
		$f_{\text{IN}} = 2482\text{ MHz}$ , $A_{\text{IN}} = -1\text{ dBFS}$	60	66		
		$f_{\text{IN}} = 2482\text{ MHz}$ , $A_{\text{IN}} = -1\text{ dBFS}$ , maximum $\text{FS\_RANGE\_A}$ and $\text{FS\_RANGE\_B}$ setting, foreground calibration		63		
		$f_{\text{IN}} = 4997\text{ MHz}$ , $A_{\text{IN}} = -1\text{ dBFS}$		56		
		$f_{\text{IN}} = 6397\text{ MHz}$ , $A_{\text{IN}} = -1\text{ dBFS}$		55		
		$f_{\text{IN}} = 8197\text{ MHz}$ , $A_{\text{IN}} = -1\text{ dBFS}$		52		
SFDR	Spurious free dynamic range, small signal, excluding DC and $F_S/2$ fixed spurs	$f_{\text{IN}} = 347\text{ MHz}$ , $A_{\text{IN}} = -16\text{ dBFS}$		73		dBFS
		$f_{\text{IN}} = 997\text{ MHz}$ , $A_{\text{IN}} = -16\text{ dBFS}$		72		
		$f_{\text{IN}} = 2482\text{ MHz}$ , $A_{\text{IN}} = -16\text{ dBFS}$		72		
		$f_{\text{IN}} = 4997\text{ MHz}$ , $A_{\text{IN}} = -16\text{ dBFS}$		72		
		$f_{\text{IN}} = 6397\text{ MHz}$ , $A_{\text{IN}} = -16\text{ dBFS}$		72		
		$f_{\text{IN}} = 8197\text{ MHz}$ , $A_{\text{IN}} = -16\text{ dBFS}$		72		
$F_S/2$	$F_S/2$ fixed interleaving spur, independent of input signal	No input		-75	-55	dBFS
HD2	2 <sup>nd</sup> order harmonic	$f_{\text{IN}} = 347\text{ MHz}$ , $A_{\text{IN}} = -1\text{ dBFS}$		-73		dBFS
		$f_{\text{IN}} = 347\text{ MHz}$ , $A_{\text{IN}} = -1\text{ dBFS}$ , maximum $\text{FS\_RANGE\_A}$ and $\text{FS\_RANGE\_B}$ setting, foreground calibration		-72		
		$f_{\text{IN}} = 997\text{ MHz}$ , $A_{\text{IN}} = -1\text{ dBFS}$		-72		
		$f_{\text{IN}} = 2482\text{ MHz}$ , $A_{\text{IN}} = -1\text{ dBFS}$		-67	-60	
		$f_{\text{IN}} = 2482\text{ MHz}$ , $A_{\text{IN}} = -1\text{ dBFS}$ , maximum $\text{FS\_RANGE\_A}$ and $\text{FS\_RANGE\_B}$ setting, foreground calibration		-66		
		$f_{\text{IN}} = 4997\text{ MHz}$ , $A_{\text{IN}} = -1\text{ dBFS}$		-58		
		$f_{\text{IN}} = 6397\text{ MHz}$ , $A_{\text{IN}} = -1\text{ dBFS}$		-57		
		$f_{\text{IN}} = 8197\text{ MHz}$ , $A_{\text{IN}} = -1\text{ dBFS}$		-58		

**Electrical Characteristics: AC Specifications (Dual-Channel Mode) (continued)**

Typical values at  $T_A = +25^\circ\text{C}$ ,  $V_{A19} = 1.9\text{V}$ ,  $V_{A11} = 1.1\text{V}$ ,  $V_{D11} = 1.1\text{V}$ , default full-scale voltage (FS\_RANGE\_A = FS\_RANGE\_B = 0xA000),  $f_{IN} = 248\text{ MHz}$ ,  $A_{IN} = -1\text{ dBFS}$ ,  $f_{CLK} =$  maximum rated clock frequency, filtered 1- $V_{PP}$  sine-wave clock, JMODE = 3 and background calibration (unless otherwise noted); minimum and maximum values are at nominal supply voltages and over operating free-air temperature range provided in the [Recommended Operating Conditions](#) table.

PARAMETER		TEST CONDITIONS	MIN	TYP	MAX	UNIT
HD3	3 <sup>rd</sup> order harmonic	$f_{IN} = 347\text{ MHz}$ , $A_{IN} = -1\text{ dBFS}$		-70		dBFS
		$f_{IN} = 347\text{ MHz}$ , $A_{IN} = -1\text{ dBFS}$ , maximum FS_RANGE_A and FS_RANGE_B setting, foreground calibration		-68		
		$f_{IN} = 997\text{ MHz}$ , $A_{IN} = -1\text{ dBFS}$		-72		
		$f_{IN} = 2482\text{ MHz}$ , $A_{IN} = -1\text{ dBFS}$		-69	-60	
		$f_{IN} = 2482\text{ MHz}$ , $A_{IN} = -1\text{ dBFS}$ , maximum FS_RANGE_A and FS_RANGE_B setting, foreground calibration		-63		
		$f_{IN} = 4997\text{ MHz}$ , $A_{IN} = -1\text{ dBFS}$		-57		
		$f_{IN} = 6397\text{ MHz}$ , $A_{IN} = -1\text{ dBFS}$		-55		
		$f_{IN} = 8197\text{ MHz}$ , $A_{IN} = -1\text{ dBFS}$		-52		
$F_S/2-F_{IN}$	$F_S/2-F_{IN}$ interleaving spur, signal dependent	$f_{IN} = 347\text{ MHz}$ , $A_{IN} = -1\text{ dBFS}$		-69		dBFS
		$f_{IN} = 997\text{ MHz}$ , $A_{IN} = -1\text{ dBFS}$		-70		
		$f_{IN} = 2482\text{ MHz}$ , $A_{IN} = -1\text{ dBFS}$		-70	-60	
		$f_{IN} = 4997\text{ MHz}$ , $A_{IN} = -1\text{ dBFS}$		-67		
		$f_{IN} = 6397\text{ MHz}$ , $A_{IN} = -1\text{ dBFS}$		-63		
		$f_{IN} = 8197\text{ MHz}$ , $A_{IN} = -1\text{ dBFS}$		-63		
SPUR	Worst harmonic 4 <sup>th</sup> order or higher	$f_{IN} = 347\text{ MHz}$ , $A_{IN} = -1\text{ dBFS}$		-72		dBFS
		$f_{IN} = 997\text{ MHz}$ , $A_{IN} = -1\text{ dBFS}$		-72		
		$f_{IN} = 2482\text{ MHz}$ , $A_{IN} = -1\text{ dBFS}$		-73	-65	
		$f_{IN} = 4997\text{ MHz}$ , $A_{IN} = -1\text{ dBFS}$		-70		
		$f_{IN} = 6397\text{ MHz}$ , $A_{IN} = -1\text{ dBFS}$		-69		
		$f_{IN} = 8197\text{ MHz}$ , $A_{IN} = -1\text{ dBFS}$		-67		
IMD3	3 <sup>rd</sup> order intermodulation	$f_{IN} = 347\text{ MHz} \pm 5\text{ MHz}$ , $A_{IN} = -7\text{ dBFS}$ per tone		-81		dBFS
		$f_{IN} = 997\text{ MHz} \pm 5\text{ MHz}$ , $A_{IN} = -7\text{ dBFS}$ per tone		-78		
		$f_{IN} = 2482\text{ MHz} \pm 5\text{ MHz}$ , $A_{IN} = -7\text{ dBFS}$ per tone		-73		
		$f_{IN} = 4997\text{ MHz} \pm 5\text{ MHz}$ , $A_{IN} = -7\text{ dBFS}$ per tone		-65		
		$f_{IN} = 6397\text{ MHz} \pm 5\text{ MHz}$ , $A_{IN} = -7\text{ dBFS}$ per tone		-56		
		$f_{IN} = 8197\text{ MHz} \pm 5\text{ MHz}$ , $A_{IN} = -7\text{ dBFS}$ per tone		-46		

## 6.8 Electrical Characteristics: AC Specifications (Single-Channel Mode)

Typical values at  $T_A = +25^\circ\text{C}$ ,  $V_{A19} = 1.9\text{V}$ ,  $V_{A11} = 1.1\text{V}$ ,  $V_{D11} = 1.1\text{V}$ , default full-scale voltage ( $\text{FS\_RANGE\_A} = 0\text{x}A000$ ), input signal applied to  $\text{INA}\pm$ ,  $f_{\text{IN}} = 248\text{ MHz}$ ,  $A_{\text{IN}} = -1\text{ dBFS}$ ,  $f_{\text{CLK}} =$  maximum rated clock frequency, filtered  $1\text{-}V_{\text{PP}}$  sine-wave clock,  $\text{JMODE} = 1$  and background calibration (unless otherwise noted); minimum and maximum values are at nominal supply voltages and over operating free-air temperature range provided in the [Recommended Operating Conditions](#) table.

PARAMETER		TEST CONDITIONS	MIN	TYP	MAX	UNIT
FPBW	Full-power input bandwidth ( $-3\text{ dB}$ ) <sup>(1)</sup>	Foreground calibration		7.9		GHz
		Background calibration		7.9		
CER	Code error rate			$10^{-18}$		errors/sample
NOISE <sub>DC</sub>	DC input noise standard deviation	No input, foreground calibration, excludes DC offset, includes fixed interleaving spurs ( $F_s/2$ and $F_s/4$ spurs)		3.5		LSB
NSD	Noise spectral density, no input signal, excludes fixed interleaving spurs ( $F_s/2$ and $F_s/4$ spur)	Maximum full-scale voltage ( $\text{FS\_RANGE\_A} = 0\text{x}FFFF$ ) setting, foreground calibration		-154.6		dBFS/Hz
		Default full-scale voltage ( $\text{FS\_RANGE\_A} = 0\text{x}A000$ ) setting, foreground calibration		-153.1		
NF	Noise figure, no input, $Z_S = 100\ \Omega$	Maximum full-scale voltage ( $\text{FS\_RANGE\_A} = 0\text{x}FFFF$ ) setting, foreground calibration		20.7		dB
		Default full-scale voltage ( $\text{FS\_RANGE\_A} = 0\text{x}A000$ ) setting, foreground calibration		19.9		
SNR	Signal to noise ratio, large signal, excluding DC, HD2 to HD9 and interleaving spurs	$f_{\text{IN}} = 347\text{ MHz}$ , $A_{\text{IN}} = -1\text{ dBFS}$		56.6		dBFS
		$f_{\text{IN}} = 347\text{ MHz}$ , $A_{\text{IN}} = -1\text{ dBFS}$ , maximum $\text{FS\_RANGE\_A}$ setting, foreground calibration		57.5		
		$f_{\text{IN}} = 997\text{ MHz}$ , $A_{\text{IN}} = -1\text{ dBFS}$		56.3		
		$f_{\text{IN}} = 2482\text{ MHz}$ , $A_{\text{IN}} = -1\text{ dBFS}$	52	55.3		
		$f_{\text{IN}} = 2482\text{ MHz}$ , $A_{\text{IN}} = -1\text{ dBFS}$ , maximum $\text{FS\_RANGE\_A}$ setting, foreground calibration		56.1		
		$f_{\text{IN}} = 4997\text{ MHz}$ , $A_{\text{IN}} = -1\text{ dBFS}$		53.0		
		$f_{\text{IN}} = 6397\text{ MHz}$ , $A_{\text{IN}} = -1\text{ dBFS}$		51.6		
		$f_{\text{IN}} = 8197\text{ MHz}$ , $A_{\text{IN}} = -1\text{ dBFS}$		50.0		
SNR	Signal to noise ratio, small signal, excluding DC, HD2 to HD9 and interleaving spurs	$f_{\text{IN}} = 347\text{ MHz}$ , $A_{\text{IN}} = -16\text{ dBFS}$		57.4		dBFS
		$f_{\text{IN}} = 997\text{ MHz}$ , $A_{\text{IN}} = -16\text{ dBFS}$		57.6		
		$f_{\text{IN}} = 2482\text{ MHz}$ , $A_{\text{IN}} = -16\text{ dBFS}$		57.4		
		$f_{\text{IN}} = 4997\text{ MHz}$ , $A_{\text{IN}} = -16\text{ dBFS}$		57.3		
		$f_{\text{IN}} = 6397\text{ MHz}$ , $A_{\text{IN}} = -16\text{ dBFS}$		57.4		
		$f_{\text{IN}} = 8197\text{ MHz}$ , $A_{\text{IN}} = -16\text{ dBFS}$		57.0		
SINAD	Signal to noise and distortion ratio, large signal, excluding DC and $F_s/2$ fixed spurs	$f_{\text{IN}} = 347\text{ MHz}$ , $A_{\text{IN}} = -1\text{ dBFS}$		52.7		dBFS
		$f_{\text{IN}} = 997\text{ MHz}$ , $A_{\text{IN}} = -1\text{ dBFS}$		52.4		
		$f_{\text{IN}} = 2482\text{ MHz}$ , $A_{\text{IN}} = -1\text{ dBFS}$	48	52.1		
		$f_{\text{IN}} = 4997\text{ MHz}$ , $A_{\text{IN}} = -1\text{ dBFS}$		47.5		
		$f_{\text{IN}} = 6397\text{ MHz}$ , $A_{\text{IN}} = -1\text{ dBFS}$		46.6		
		$f_{\text{IN}} = 8197\text{ MHz}$ , $A_{\text{IN}} = -1\text{ dBFS}$		47.7		

(1) Full-power input bandwidth (FPBW) is defined as the input frequency where the reconstructed output of the ADC has dropped 3 dB below the power of a full-scale input signal at a low input frequency. Useable bandwidth may exceed the  $-3\text{-dB}$  full-power input bandwidth.

**Electrical Characteristics: AC Specifications (Single-Channel Mode) (continued)**

Typical values at  $T_A = +25^\circ\text{C}$ ,  $V_{A19} = 1.9\text{V}$ ,  $V_{A11} = 1.1\text{V}$ ,  $V_{D11} = 1.1\text{V}$ , default full-scale voltage ( $\text{FS\_RANGE\_A} = 0\text{x}A000$ ), input signal applied to  $\text{INA}\pm$ ,  $f_{\text{IN}} = 248\text{ MHz}$ ,  $A_{\text{IN}} = -1\text{ dBFS}$ ,  $f_{\text{CLK}} =$  maximum rated clock frequency, filtered  $1\text{-}V_{\text{PP}}$  sine-wave clock,  $\text{JMODE} = 1$  and background calibration (unless otherwise noted); minimum and maximum values are at nominal supply voltages and over operating free-air temperature range provided in the [Recommended Operating Conditions](#) table.

PARAMETER		TEST CONDITIONS	MIN	TYP	MAX	UNIT
ENOB	Effective number of bits, large signal, excluding DC and $F_S/2$ fixed spurs	$f_{\text{IN}} = 347\text{ MHz}$ , $A_{\text{IN}} = -1\text{ dBFS}$		8.6		Bits
		$f_{\text{IN}} = 997\text{ MHz}$ , $A_{\text{IN}} = -1\text{ dBFS}$		8.5		
		$f_{\text{IN}} = 2482\text{ MHz}$ , $A_{\text{IN}} = -1\text{ dBFS}$	7.7	8.4		
		$f_{\text{IN}} = 4997\text{ MHz}$ , $A_{\text{IN}} = -1\text{ dBFS}$		7.7		
		$f_{\text{IN}} = 6397\text{ MHz}$ , $A_{\text{IN}} = -1\text{ dBFS}$		7.5		
		$f_{\text{IN}} = 8197\text{ MHz}$ , $A_{\text{IN}} = -1\text{ dBFS}$		7.6		
SFDR	Spurious free dynamic range, large signal, excluding DC, $F_S/4$ and $F_S/2$ fixed spurs	$f_{\text{IN}} = 347\text{ MHz}$ , $A_{\text{IN}} = -1\text{ dBFS}$		67		dBFS
		$f_{\text{IN}} = 347\text{ MHz}$ , $A_{\text{IN}} = -1\text{ dBFS}$ , maximum $\text{FS\_RANGE\_A}$ setting, foreground calibration		64		
		$f_{\text{IN}} = 997\text{ MHz}$ , $A_{\text{IN}} = -1\text{ dBFS}$		63		
		$f_{\text{IN}} = 2482\text{ MHz}$ , $A_{\text{IN}} = -1\text{ dBFS}$	50	58		
		$f_{\text{IN}} = 2482\text{ MHz}$ , $A_{\text{IN}} = -1\text{ dBFS}$ , maximum $\text{FS\_RANGE\_A}$ setting, foreground calibration		55		
		$f_{\text{IN}} = 4997\text{ MHz}$ , $A_{\text{IN}} = -1\text{ dBFS}$		51		
		$f_{\text{IN}} = 6397\text{ MHz}$ , $A_{\text{IN}} = -1\text{ dBFS}$		50		
		$f_{\text{IN}} = 8197\text{ MHz}$ , $A_{\text{IN}} = -1\text{ dBFS}$		48		
SFDR	Spurious free dynamic range, small signal, excluding DC, $F_S/4$ and $F_S/2$ fixed spurs	$f_{\text{IN}} = 347\text{ MHz}$ , $A_{\text{IN}} = -16\text{ dBFS}$		75		dBFS
		$f_{\text{IN}} = 997\text{ MHz}$ , $A_{\text{IN}} = -16\text{ dBFS}$		73		
		$f_{\text{IN}} = 2482\text{ MHz}$ , $A_{\text{IN}} = -16\text{ dBFS}$		72		
		$f_{\text{IN}} = 4997\text{ MHz}$ , $A_{\text{IN}} = -16\text{ dBFS}$		66		
		$f_{\text{IN}} = 6397\text{ MHz}$ , $A_{\text{IN}} = -16\text{ dBFS}$		65		
		$f_{\text{IN}} = 8197\text{ MHz}$ , $A_{\text{IN}} = -16\text{ dBFS}$		63		
$F_S/2$	$F_S/2$ fixed interleaving spur, independent of input signal	No input, $\text{OS\_CAL}$ disabled. Spur can be improved by running $\text{OS\_CAL}$ .		-56		dBFS
$F_S/4$	$F_S/4$ fixed interleaving spur, independent of input signal	No input		-65	-55	dBFS
HD2	2 <sup>nd</sup> order harmonic	$f_{\text{IN}} = 347\text{ MHz}$ , $A_{\text{IN}} = -1\text{ dBFS}$		-73		dBFS
		$f_{\text{IN}} = 347\text{ MHz}$ , $A_{\text{IN}} = -1\text{ dBFS}$ , maximum $\text{FS\_RANGE\_A}$ setting, foreground calibration		-76		
		$f_{\text{IN}} = 997\text{ MHz}$ , $A_{\text{IN}} = -1\text{ dBFS}$		-74		
		$f_{\text{IN}} = 2482\text{ MHz}$ , $A_{\text{IN}} = -1\text{ dBFS}$		-68	-60	
		$f_{\text{IN}} = 2482\text{ MHz}$ , $A_{\text{IN}} = -1\text{ dBFS}$ , maximum $\text{FS\_RANGE\_A}$ setting, foreground calibration		-72		
		$f_{\text{IN}} = 4997\text{ MHz}$ , $A_{\text{IN}} = -1\text{ dBFS}$		-62		
		$f_{\text{IN}} = 6397\text{ MHz}$ , $A_{\text{IN}} = -1\text{ dBFS}$		-62		
		$f_{\text{IN}} = 8197\text{ MHz}$ , $A_{\text{IN}} = -1\text{ dBFS}$		-61		

**Electrical Characteristics: AC Specifications (Single-Channel Mode) (continued)**

Typical values at  $T_A = +25^\circ\text{C}$ ,  $V_{A19} = 1.9\text{V}$ ,  $V_{A11} = 1.1\text{V}$ ,  $V_{D11} = 1.1\text{V}$ , default full-scale voltage ( $\text{FS\_RANGE\_A} = 0\text{x}A000$ ), input signal applied to  $\text{INA}\pm$ ,  $f_{\text{IN}} = 248\text{ MHz}$ ,  $A_{\text{IN}} = -1\text{ dBFS}$ ,  $f_{\text{CLK}} =$  maximum rated clock frequency, filtered  $1\text{-}V_{\text{PP}}$  sine-wave clock,  $\text{JMODE} = 1$  and background calibration (unless otherwise noted); minimum and maximum values are at nominal supply voltages and over operating free-air temperature range provided in the [Recommended Operating Conditions](#) table.

PARAMETER		TEST CONDITIONS	MIN	TYP	MAX	UNIT
HD3	3 <sup>rd</sup> order harmonic	$f_{\text{IN}} = 347\text{ MHz}$ , $A_{\text{IN}} = -1\text{ dBFS}$		-70		dBFS
		$f_{\text{IN}} = 347\text{ MHz}$ , $A_{\text{IN}} = -1\text{ dBFS}$ , maximum $\text{FS\_RANGE\_A}$ setting, foreground calibration		-68		
		$f_{\text{IN}} = 997\text{ MHz}$ , $A_{\text{IN}} = -1\text{ dBFS}$		-68		
		$f_{\text{IN}} = 2482\text{ MHz}$ , $A_{\text{IN}} = -1\text{ dBFS}$		-69	-60	
		$f_{\text{IN}} = 2482\text{ MHz}$ , $A_{\text{IN}} = -1\text{ dBFS}$ , maximum $\text{FS\_RANGE\_A}$ setting, foreground calibration		-64		
		$f_{\text{IN}} = 4997\text{ MHz}$ , $A_{\text{IN}} = -1\text{ dBFS}$		-59		
		$f_{\text{IN}} = 6397\text{ MHz}$ , $A_{\text{IN}} = -1\text{ dBFS}$		-58		
$F_S/2\text{-}F_{\text{IN}}$	$F_S/2\text{-}F_{\text{IN}}$ interleaving spur, signal dependent	$f_{\text{IN}} = 347\text{ MHz}$ , $A_{\text{IN}} = -1\text{ dBFS}$		-68		dBFS
		$f_{\text{IN}} = 997\text{ MHz}$ , $A_{\text{IN}} = -1\text{ dBFS}$		-63		
		$f_{\text{IN}} = 2482\text{ MHz}$ , $A_{\text{IN}} = -1\text{ dBFS}$		-58	-50	
		$f_{\text{IN}} = 4997\text{ MHz}$ , $A_{\text{IN}} = -1\text{ dBFS}$		-51		
		$f_{\text{IN}} = 6397\text{ MHz}$ , $A_{\text{IN}} = -1\text{ dBFS}$		-50		
$F_S/4\pm F_{\text{IN}}$	$F_S/4\pm F_{\text{IN}}$ interleaving spurs, signal dependent	$f_{\text{IN}} = 347\text{ MHz}$ , $A_{\text{IN}} = -1\text{ dBFS}$		-74		dBFS
		$f_{\text{IN}} = 997\text{ MHz}$ , $A_{\text{IN}} = -1\text{ dBFS}$		-69		
		$f_{\text{IN}} = 2482\text{ MHz}$ , $A_{\text{IN}} = -1\text{ dBFS}$		-70	-60	
		$f_{\text{IN}} = 4997\text{ MHz}$ , $A_{\text{IN}} = -1\text{ dBFS}$		-66		
		$f_{\text{IN}} = 6397\text{ MHz}$ , $A_{\text{IN}} = -1\text{ dBFS}$		-63		
SPUR	Worst harmonic 4 <sup>th</sup> order or higher	$f_{\text{IN}} = 347\text{ MHz}$ , $A_{\text{IN}} = -1\text{ dBFS}$		-73		dBFS
		$f_{\text{IN}} = 997\text{ MHz}$ , $A_{\text{IN}} = -1\text{ dBFS}$		-73		
		$f_{\text{IN}} = 2482\text{ MHz}$ , $A_{\text{IN}} = -1\text{ dBFS}$		-75	-65	
		$f_{\text{IN}} = 4997\text{ MHz}$ , $A_{\text{IN}} = -1\text{ dBFS}$		-69		
		$f_{\text{IN}} = 6397\text{ MHz}$ , $A_{\text{IN}} = -1\text{ dBFS}$		-69		
IMD3	3 <sup>rd</sup> order intermodulation	$f_{\text{IN}} = 347\text{ MHz} \pm 5\text{ MHz}$ , $A_{\text{IN}} = -7\text{ dBFS}$ per tone		-80		dBFS
		$f_{\text{IN}} = 997\text{ MHz} \pm 5\text{ MHz}$ , $A_{\text{IN}} = -7\text{ dBFS}$ per tone		-75		
		$f_{\text{IN}} = 2482\text{ MHz} \pm 5\text{ MHz}$ , $A_{\text{IN}} = -7\text{ dBFS}$ per tone		-72		
		$f_{\text{IN}} = 4997\text{ MHz} \pm 5\text{ MHz}$ , $A_{\text{IN}} = -7\text{ dBFS}$ per tone		-63		
		$f_{\text{IN}} = 6397\text{ MHz} \pm 5\text{ MHz}$ , $A_{\text{IN}} = -7\text{ dBFS}$ per tone		-65		
		$f_{\text{IN}} = 8197\text{ MHz} \pm 5\text{ MHz}$ , $A_{\text{IN}} = -7\text{ dBFS}$ per tone		-50		

## 6.9 Timing Requirements

		MIN	NOM	MAX	UNIT
<b>DEVICE (SAMPLING) CLOCK (CLK+, CLK–)</b>					
$f_{CLK}$	Input clock frequency (CLK+, CLK–), both single channel and dual channel modes <sup>(1)</sup>	800		3200	MHz
<b>SYSREF (SYSREF+, SYSREF–)</b>					
$t_{INV(SYSREF)}$	Width of invalid SYSREF capture region of CLK+/- period, indicating setup or hold time violation, as measured by SYSREF_POS status register <sup>(2)</sup>		48		ps
$t_{INV(TEMP)}$	Drift of invalid SYSREF capture region over temperature, positive number indicates a shift toward MSB of SYSREF_POS register		0		ps/°C
$t_{INV(VA11)}$	Drift of invalid SYSREF capture region over VA11 supply voltage, positive number indicates a shift toward MSB of SYSREF_POS register		0.36		ps/mV
$t_{STEP(SP)}$	Delay of SYSREF_POS LSB	SYSREF_ZOOM = 0		77	ps
		SYSREF_ZOOM = 1		24	ps
$t_{(PH\_SYS)}$	Minimum SYSREF+/- assertion duration after SYSREF+/- rising edge event		4		ns
$t_{(PL\_SYS)}$	Minimum SYSREF+/- deassertion duration after SYSREF+/- falling edge event		1		ns
<b>JESD204B SYNC TIMING (<math>\overline{SYNCSE}</math> OR <math>TMSTP+/-</math>)</b>					
$t_{H(\overline{SYNCSE})}$	Minimum hold time from multi-frame boundary (SYSREF rising edge captured high) to de-assertion of JESD204B SYNC signal ( $\overline{SYNCSE}$ if $SYNC\_SEL = 0$ or $TMSTP+/-$ if $SYNC\_SEL = 1$ ) for NCO synchronization ( $NCO\_SYNC\_ILA = 1$ )	JMODE = 0, 2, 4, 6, 10, 13 or 15		21	$t_{CLK}$ cycles
		JMODE = 1, 3, 5, 7, 9, 11, 14 or 16		17	
		JMODE = 12, 17 or 18		9	
$t_{SU(\overline{SYNCSE})}$	Minimum setup time from de-assertion of JESD204B SYNC signal ( $\overline{SYNCSE}$ if $SYNC\_SEL = 0$ or $TMSTP+/-$ if $SYNC\_SEL = 1$ ) to multi-frame boundary (SYSREF rising edge captured high) for NCO synchronization ( $NCO\_SYNC\_ILA = 1$ )	JMODE = 0, 2, 4, 6, 10, 13 or 15		-2	$t_{CLK}$ cycles
		JMODE = 1, 3, 5, 7, 9, 11, 14 or 16		2	
		JMODE = 12, 17 or 18		10	
$t_{(\overline{SYNCSE})}$	$\overline{SYNCSE}$ minimum assertion time to trigger link resynchronization		4		Frames
<b>SERIAL PROGRAMMING INTERFACE (SCLK, SDI, <math>\overline{SCS}</math>)</b>					
$f_{CLK(SCLK)}$	Maximum serial clock frequency		15.625		MHz
$t_{(PH)}$	Minimum serial clock high value pulse width		32		ns
$t_{(PL)}$	Minimum serial clock low value pulse width		32		ns
$t_{SU(\overline{SCS})}$	Minimum setup time from $\overline{SCS}$ to rising edge of SCLK		30		ns
$t_{H(\overline{SCS})}$	Minimum hold time from rising edge of SCLK to $\overline{SCS}$		3		ns
$t_{SU(SDI)}$	Minimum setup time from SDI to rising edge of SCLK		30		ns
$t_{H(SDI)}$	Minimum hold time from rising edge of SCLK to SDI		3		ns

(1) Unless functionally limited to a smaller range in 表 19 based on programmed JMODE.

(2) SYSREF\_POS should be used to select an optimal SYSREF\_SEL value for SYSREF capture, see [SYSREF Position Detector and Sampling Position Selection \(SYSREF Windowing\)](#) for more information on SYSREF Windowing. The invalid region, specified by  $t_{INV(SYSREF)}$ , indicates the portion of the CLK+/- period ( $t_{CLK}$ ), as measured by SYSREF\_SEL, that may result in a setup and hold violation. The user should verify that the timing skew between SYSREF+/- and CLK+/- over system operating conditions from the nominal conditions (that used to find optimal SYSREF\_SEL) does not result in the invalid region occurring at the selected SYSREF\_SEL position in SYSREF\_POS, otherwise a temperature dependent SYSREF\_SEL selection may be needed to track the skew between CLK+/- and SYSREF+/-.



## 6.10 Switching Characteristics

Typical values at  $T_A = +25^\circ\text{C}$ ,  $V_{A19} = 1.9\text{V}$ ,  $V_{A11} = 1.1\text{V}$ ,  $V_{D11} = 1.1\text{V}$ , default full-scale voltage ( $\text{FS\_RANGE\_A} = \text{FS\_RANGE\_B} = 0\text{x}A000$ ), input signal applied to  $\text{INA+/-}$  in single channel modes,  $f_{\text{IN}} = 248\text{ MHz}$ ,  $A_{\text{IN}} = -1\text{ dBFS}$ ,  $f_{\text{CLK}} =$  maximum rated clock frequency, filtered 1-Vpp sine-wave clock,  $\text{JMODE} = 1$ , background calibration, unless otherwise noted. Minimum and maximum values are at nominal supply voltages and over operating free-air temperature range provided in [Recommended Operating Conditions](#).

PARAMETER	TEST CONDITIONS	MIN	TYP	MAX	UNIT
<b>DEVICE (SAMPLING) CLOCK (CLK+, CLK-)</b>					
$t_{\text{AD}}$	Sampling (aperture) delay from CLK+/- rising edge (dual channel mode) or rising and falling edge (single channel mode) to sampling instant	TAD_COARSE = 0x00, TAD_FINE = 0x00 and TAD_INV = 0		360	ps
$t_{\text{TAD(MAX)}}$	Maximum $t_{\text{AD}}$ Adjust programmable delay, not including clock inversion (TAD_INV = 0)	Coarse adjustment (TAD_COARSE = 0xFF)		289	ps
		Fine adjustment (TAD_FINE = 0xFF)		4.9	ps
$t_{\text{TAD(STEP)}}$	$t_{\text{AD}}$ Adjust programmable delay step size	Coarse adjustment (TAD_COARSE)		1.13	ps
		Fine adjustment (TAD_FINE)		19	fs
$t_{\text{AJ}}$	Aperture jitter, rms	Minimum $t_{\text{AD}}$ Adjust coarse setting (TAD_COARSE = 0x00, TAD_INV = 0)		50	fs
		Maximum $t_{\text{AD}}$ Adjust coarse setting (TAD_COARSE = 0xFF) excluding TAD_INV (TAD_INV = 0)		70 <sup>(1)</sup>	fs
<b>SERIAL DATA OUTPUTS (DA0+...DA7+, DA0-...DA7-, DB0+...DB7+, DB0-...DB7-)</b>					
$f_{\text{SERDES}}$	Serialized output bit rate	1		12.8	Gbps
UI	Serialized output unit interval	78.125		1000	ps
$t_{\text{TLH}}$	Low-to-high transition time (differential)	20% to 80%, PRBS-7 test pattern, 12.8 Gbps, SER_PE = 0x04		37	ps
$t_{\text{THL}}$	High-to-low transition time (differential)	20% to 80%, PRBS-7 test pattern, 12.8 Gbps, SER_PE = 0x04		37	ps
DDJ	Data dependent jitter, peak-to-peak	PRBS-7 test pattern, 12.8 Gbps, SER_PE = 0x04, JMODE = 2		7.8	ps
RJ	Random jitter, RMS	PRBS-7 test pattern, 12.8 Gbps, SER_PE = 0x04, JMODE = 2		1.1	ps
TJ	Total jitter, peak-to-peak, with gaussian portion defined with respect to a BER=1e-15 (Q=7.94)	PRBS-7 test pattern, 12.8 Gbps, SER_PE = 0x04, JMODE = 0, 2		25	ps
		PRBS-7 test pattern, 6.4 Gbps, SER_PE = 0x04, JMODE = 1, 3		21	ps
		PRBS-7 test pattern, 8 Gbps, SER_PE = 0x04, JMODE = 4, 5, 6, 7		28	ps
		PRBS-7 test pattern, 8 Gbps, SER_PE = 0x04, JMODE = 9		35	ps
		PRBS-7 test pattern, 8 Gbps, SER_PE = 0x04, JMODE = 10, 11		40	ps
		PRBS-7 test pattern, 3.2 Gbps, SER_PE = 0x04, JMODE = 12		26	ps
		PRBS-7 test pattern, 8 Gbps, SER_PE = 0x04, JMODE = 13, 14		39	ps
PRBS-7 test pattern, 8 Gbps, SER_PE = 0x04, JMODE = 15, 16		34	ps		

(1)  $t_{\text{AJ}}$  increases due to additional attenuation on internal clock path.

### Switching Characteristics (continued)

Typical values at  $T_A = +25^\circ\text{C}$ ,  $V_{A19} = 1.9\text{V}$ ,  $V_{A11} = 1.1\text{V}$ ,  $V_{D11} = 1.1\text{V}$ , default full-scale voltage (FS\_RANGE\_A = FS\_RANGE\_B = 0xA000), input signal applied to INA+/- in single channel modes,  $f_{IN} = 248\text{ MHz}$ ,  $A_{IN} = -1\text{ dBFS}$ ,  $f_{CLK} =$  maximum rated clock frequency, filtered 1-Vpp sine-wave clock, JMODE = 1, background calibration, unless otherwise noted. Minimum and maximum values are at nominal supply voltages and over operating free-air temperature range provided in [Recommended Operating Conditions](#).

PARAMETER	TEST CONDITIONS	MIN	TYP	MAX	UNIT
<b>ADC CORE LATENCY</b>					
$t_{ADC}$	Deterministic delay from the CLK+/- edge that samples the reference sample to the CLK+/- edge that samples SYSREF going high <sup>(2)</sup>	JMODE = 0		-8.5	$t_{CLK}$ cycles
		JMODE = 1		-20.5	
		JMODE = 2		-9	
		JMODE = 3		-21	
		JMODE = 4		-4.5	
		JMODE = 5		-24.5	
		JMODE = 6		-5	
		JMODE = 7		-25	
		JMODE = 9		60	
		JMODE = 10		140	
		JMODE = 11		136	
		JMODE = 12		120	
		JMODE = 13		232	
		JMODE = 14		232	
		JMODE = 15		446	
		JMODE = 16		430	
JMODE = 17		-48.5			
JMODE = 18		-49			
<b>JESD204B AND SERIALIZER LATENCY</b>					
$t_{TX}$	Delay from the CLK+/- rising edge that samples SYSREF high to the first bit of the multi-frame on the JESD204B serial output lane corresponding to the reference sample of $t_{ADC}$ <sup>(3)</sup>	JMODE = 0	72	84	$t_{CLK}$ cycles
		JMODE = 1	119	132	
		JMODE = 2	72	84	
		JMODE = 3	119	132	
		JMODE = 4	67	80	
		JMODE = 5	106	119	
		JMODE = 6	67	80	
		JMODE = 7	106	119	
		JMODE = 9	106	119	
		JMODE = 10	67	80	
		JMODE = 11	106	119	
		JMODE = 12	213	225	
		JMODE = 13	67	80	
		JMODE = 14	106	119	
		JMODE = 15	67	80	
		JMODE = 16	106	119	
JMODE = 17	195	208			
JMODE = 18	195	208			

- (2)  $t_{ADC}$  is an exact, unrounded, deterministic delay. The delay can be negative if the reference sample is sampled after the SYSREF high capture point, in which case the total latency is smaller than the delay given by  $t_{TX}$ .
- (3) The values given for  $t_{TX}$  include deterministic and non-deterministic delays. Over process, temperature, and voltage, the delay will vary. JESD204B accounts for these variations when operating in subclass-1 mode in order to achieve deterministic latency. Proper receiver RBD value must be chosen such that the elastic buffer release point does not occur within the invalid region of the local multi-frame clock (LMFC) cycle.

### Switching Characteristics (continued)

Typical values at  $T_A = +25^\circ\text{C}$ ,  $V_{A19} = 1.9\text{V}$ ,  $V_{A11} = 1.1\text{V}$ ,  $V_{D11} = 1.1\text{V}$ , default full-scale voltage (FS\_RANGE\_A = FS\_RANGE\_B = 0xA000), input signal applied to INA+/- in single channel modes,  $f_{IN} = 248\text{ MHz}$ ,  $A_{IN} = -1\text{ dBFS}$ ,  $f_{CLK} =$  maximum rated clock frequency, filtered 1-Vpp sine-wave clock, JMODE = 1, background calibration, unless otherwise noted. Minimum and maximum values are at nominal supply voltages and over operating free-air temperature range provided in [Recommended Operating Conditions](#).

PARAMETER	TEST CONDITIONS	MIN	TYP	MAX	UNIT
<b>SERIAL PROGRAMMING INTERFACE (SDO)</b>					
$t_{(OZD)}$	Maximum delay from falling edge of 16th SCLK cycle during read operation for SDO transition from tri-state to valid data		7		ns
$t_{(ODZ)}$	Maximum delay from $\overline{\text{SCS}}$ rising edge for SDO transition from valid data to tri-state		7		ns
$t_{(OD)}$	Maximum delay from falling edge of 16th SCLK cycle during read operation to SDO valid		12		ns

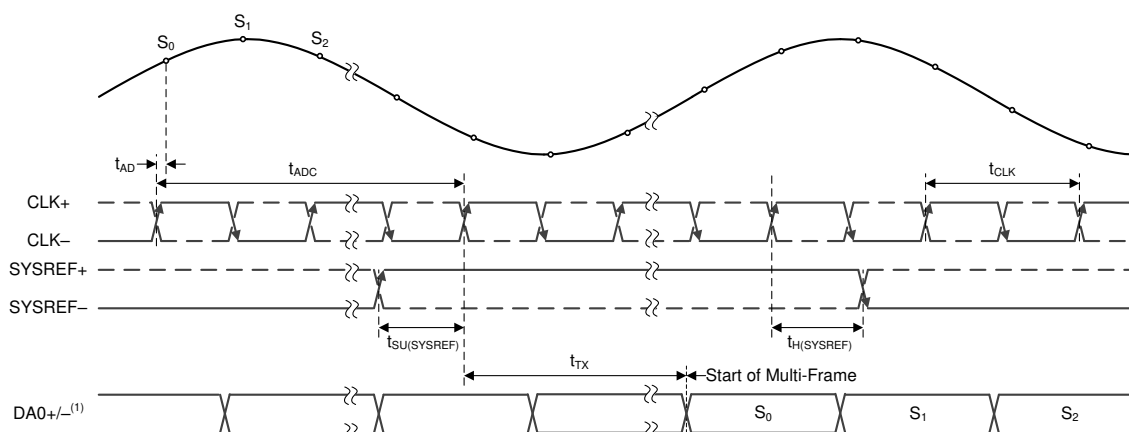

- (1) Only the SerDes lane  $\text{DA}0\pm$  is shown, but  $\text{DA}0\pm$  is representative of all lanes. The number of output lanes used and bit-packing format is dependent on the programmed JMODE value.

图 1. ADC Timing Diagram

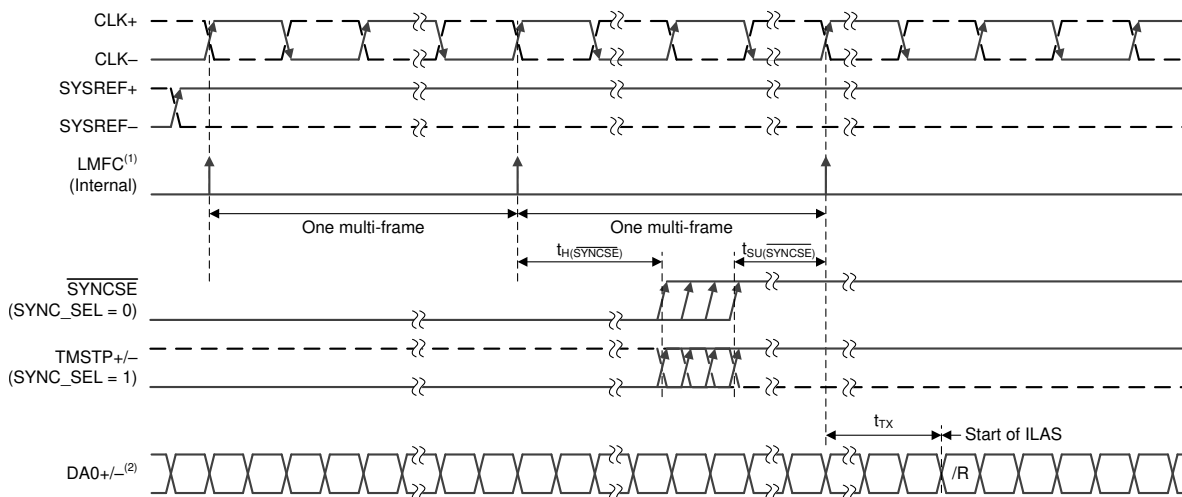

- (2) The internal LMFC is assumed to be aligned with the  $\text{CLK}\pm$  rising edge that captures the  $\text{SYSREF}\pm$  high value.  
 (3) Only SerDes lane  $\text{DA}0\pm$  is shown, but  $\text{DA}0\pm$  is representative of all lanes. All lanes output /R at approximately the same point in time. The number of lanes is dependent on the programmed JMODE value.

图 2. SYNCSE and TMSTP± Timing Diagram for NCO Synchronization

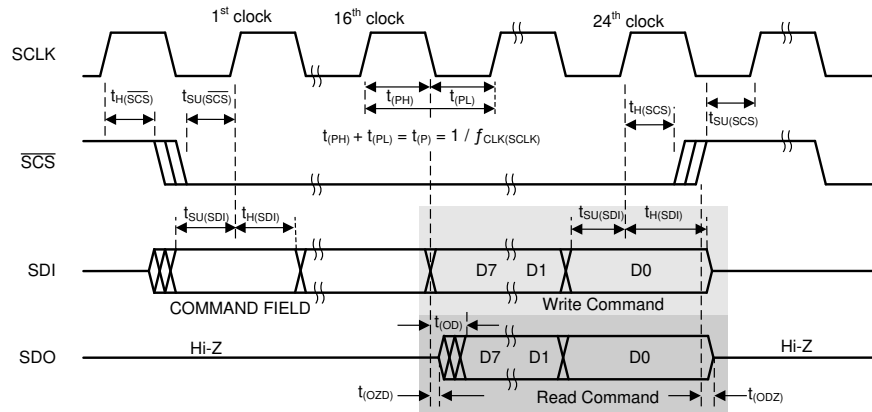
**图 3. Serial Interface Timing**

### 6.11 Typical Characteristics

typical values at  $T_A = 25^\circ\text{C}$ ,  $V_{A19} = 1.9\text{ V}$ ,  $V_{A11} = V_{D11} = 1.1\text{ V}$ , default full-scale voltage ( $\text{FS\_RANGE\_A} = \text{FS\_RANGE\_B} = 0x\text{A000}$ ), input signal applied to  $\text{INA}\pm$  in single-channel modes,  $f_{\text{IN}} = 347\text{ MHz}$ ,  $A_{\text{IN}} = -1\text{ dBFS}$ ,  $f_{\text{CLK}} =$  maximum-rated clock frequency, filtered,  $1\text{-}V_{\text{PP}}$  sine-wave clock,  $\text{JMODE} = 1$ , and background calibration (unless otherwise noted); SNR results exclude DC, HD2 to HD9 and interleaving spurs; SINAD, ENOB, and SFDR results exclude DC and fixed-frequency interleaving spurs

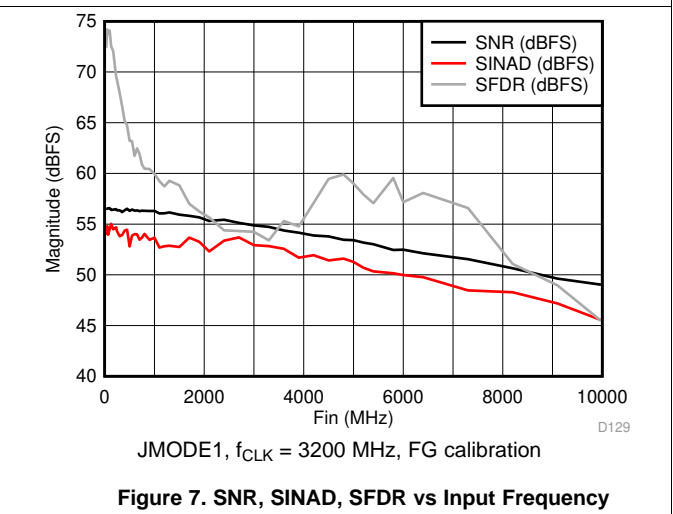
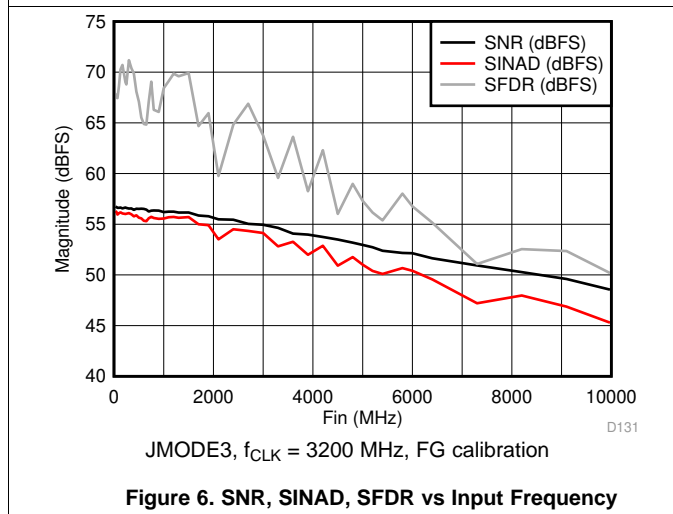
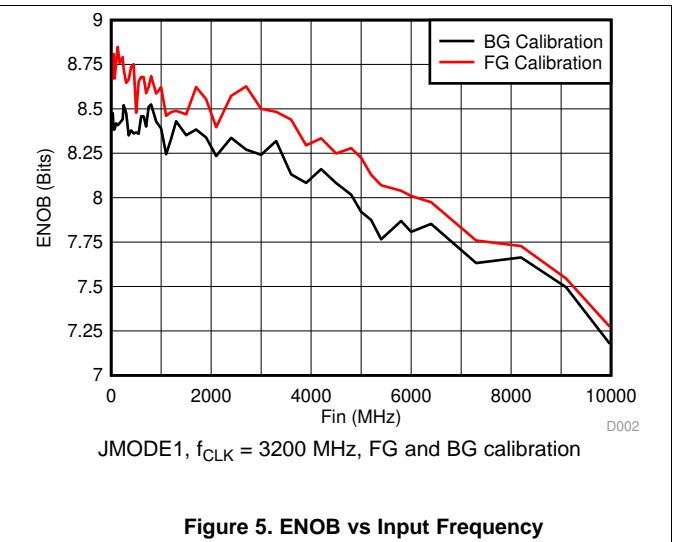
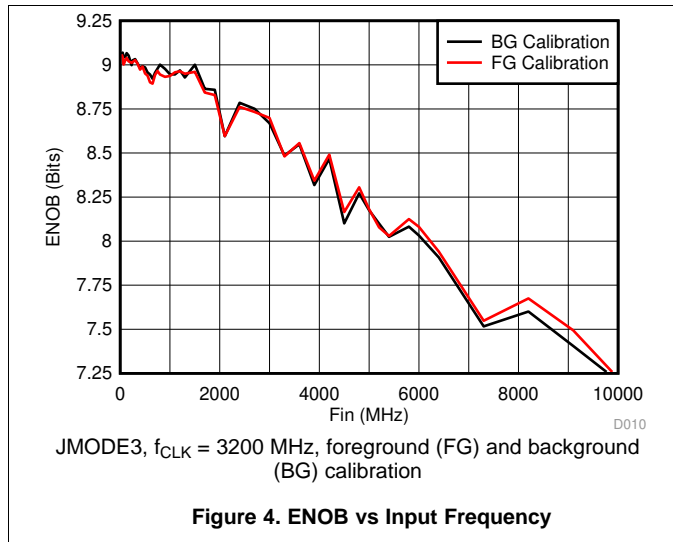

### Typical Characteristics (continued)

typical values at  $T_A = 25^\circ\text{C}$ ,  $V_{A19} = 1.9\text{ V}$ ,  $V_{A11} = V_{D11} = 1.1\text{ V}$ , default full-scale voltage ( $\text{FS\_RANGE\_A} = \text{FS\_RANGE\_B} = 0x\text{A000}$ ), input signal applied to  $\text{INA}\pm$  in single-channel modes,  $f_{\text{IN}} = 347\text{ MHz}$ ,  $A_{\text{IN}} = -1\text{ dBFS}$ ,  $f_{\text{CLK}} =$  maximum-rated clock frequency, filtered,  $1\text{-}V_{\text{PP}}$  sine-wave clock,  $\text{JMODE} = 1$ , and background calibration (unless otherwise noted); SNR results exclude DC, HD2 to HD9 and interleaving spurs; SINAD, ENOB, and SFDR results exclude DC and fixed-frequency interleaving spurs

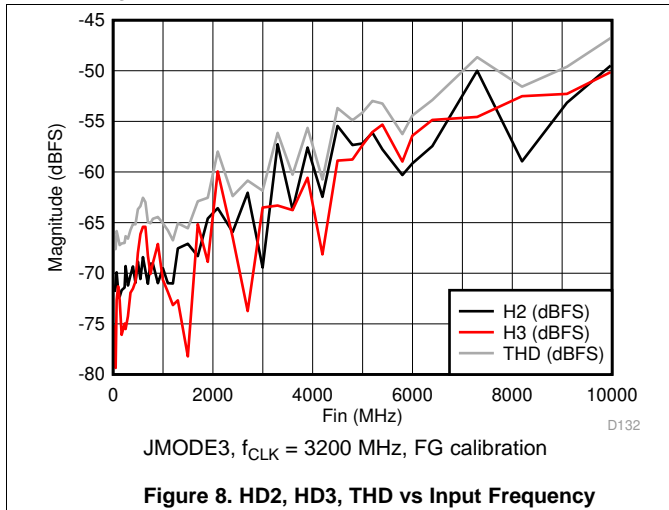

Figure 8. HD2, HD3, THD vs Input Frequency

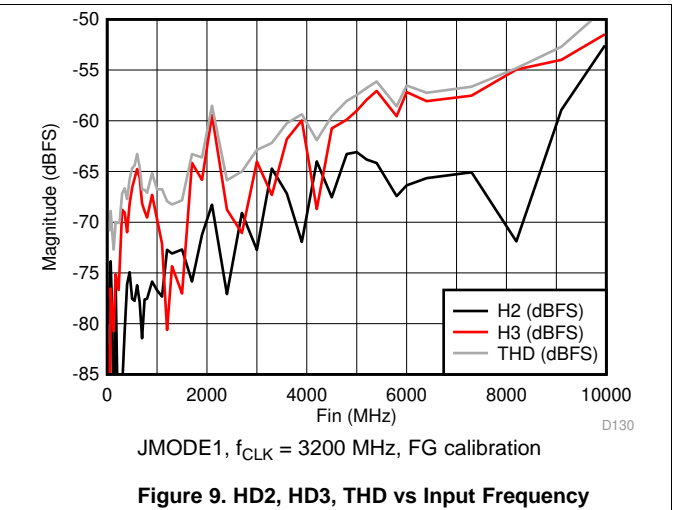

Figure 9. HD2, HD3, THD vs Input Frequency

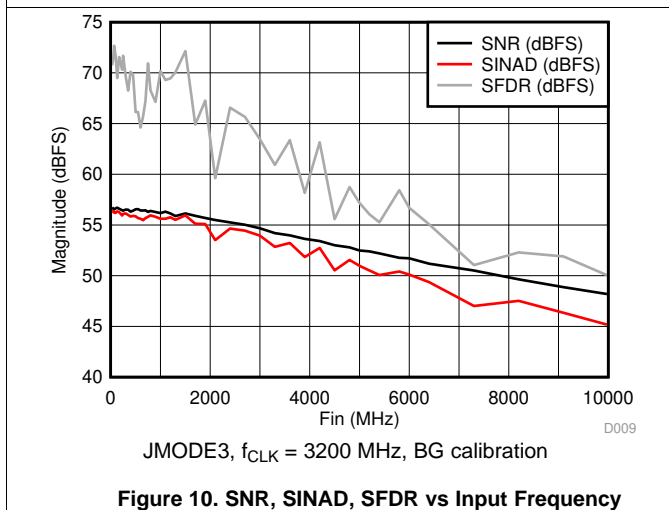

Figure 10. SNR, SINAD, SFDR vs Input Frequency

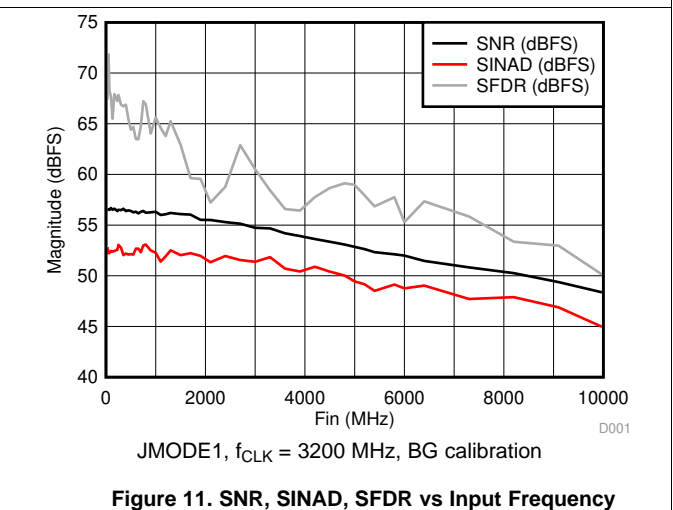

Figure 11. SNR, SINAD, SFDR vs Input Frequency

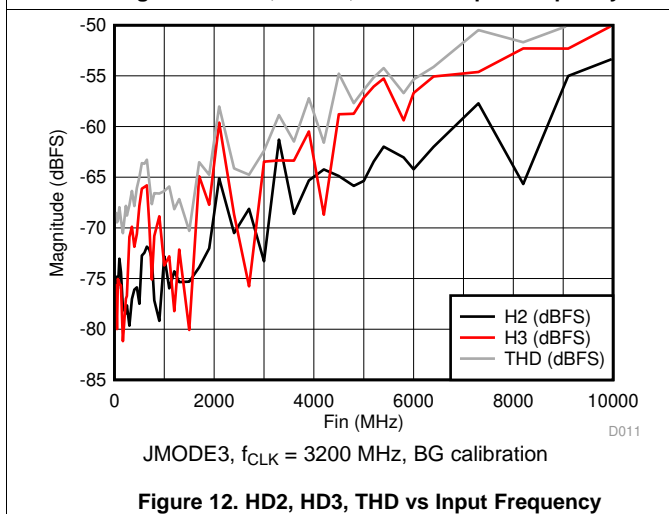

Figure 12. HD2, HD3, THD vs Input Frequency

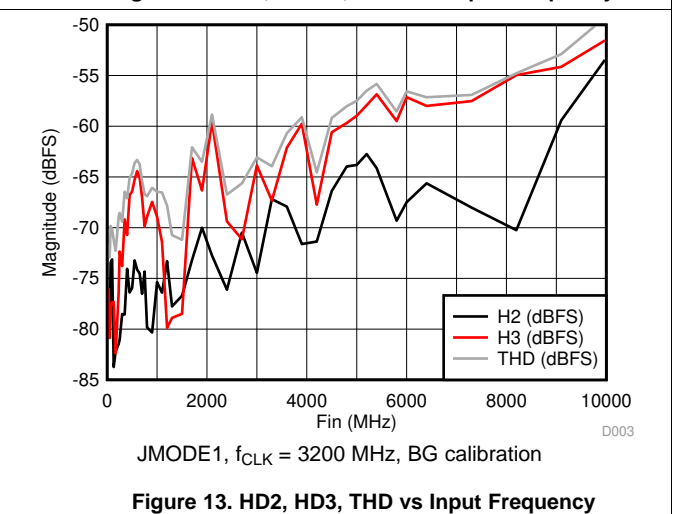

Figure 13. HD2, HD3, THD vs Input Frequency



Typical Characteristics (continued)

typical values at  $T_A = 25^\circ\text{C}$ ,  $V_{A19} = 1.9\text{ V}$ ,  $V_{A11} = V_{D11} = 1.1\text{ V}$ , default full-scale voltage ( $\text{FS\_RANGE\_A} = \text{FS\_RANGE\_B} = 0x\text{A000}$ ), input signal applied to  $\text{INA}\pm$  in single-channel modes,  $f_{\text{IN}} = 347\text{ MHz}$ ,  $A_{\text{IN}} = -1\text{ dBFS}$ ,  $f_{\text{CLK}} =$  maximum-rated clock frequency, filtered,  $1\text{-}V_{\text{PP}}$  sine-wave clock,  $\text{JMODE} = 1$ , and background calibration (unless otherwise noted); SNR results exclude DC, HD2 to HD9 and interleaving spurs; SINAD, ENOB, and SFDR results exclude DC and fixed-frequency interleaving spurs

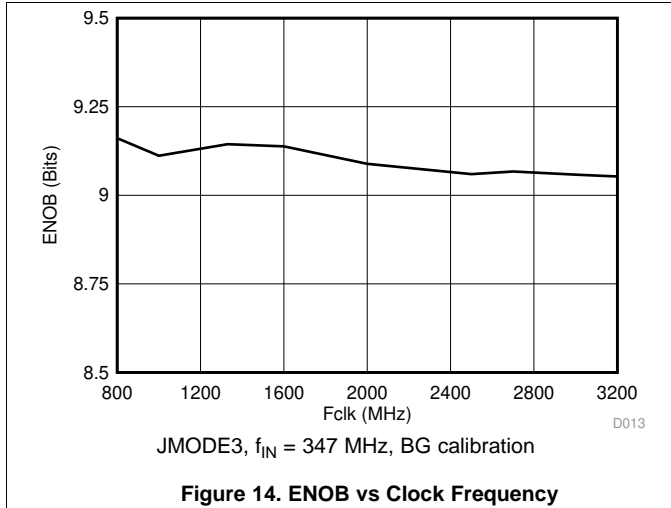

Figure 14. ENOB vs Clock Frequency

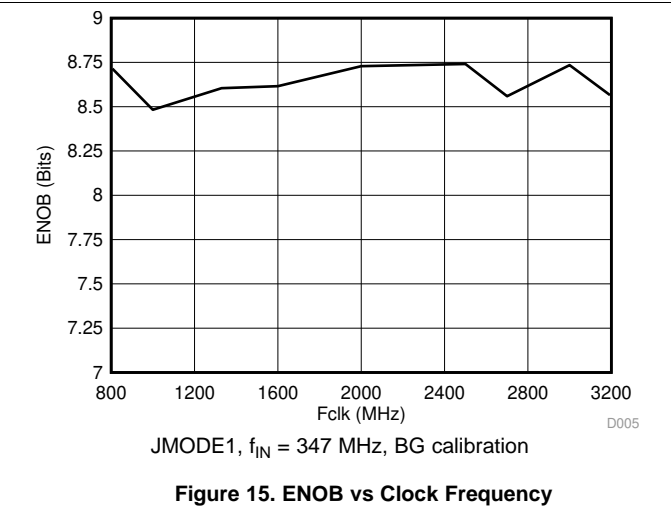

Figure 15. ENOB vs Clock Frequency

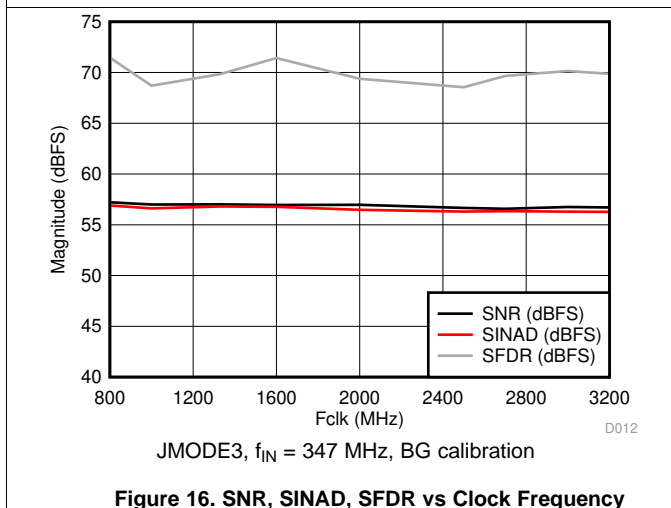

Figure 16. SNR, SINAD, SFDR vs Clock Frequency

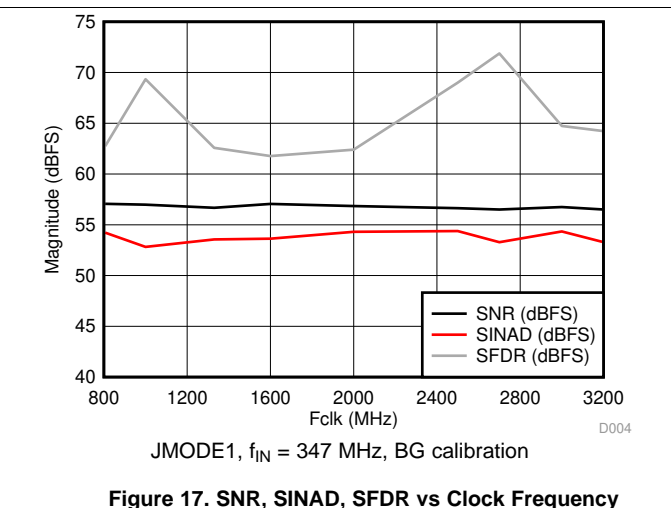

Figure 17. SNR, SINAD, SFDR vs Clock Frequency

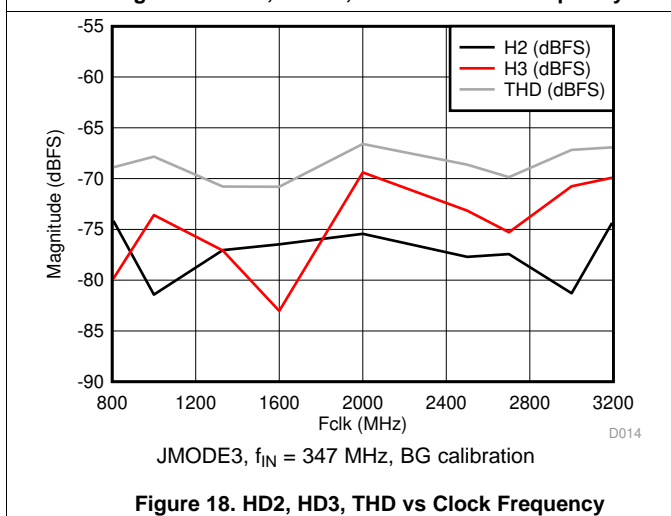

Figure 18. HD2, HD3, THD vs Clock Frequency

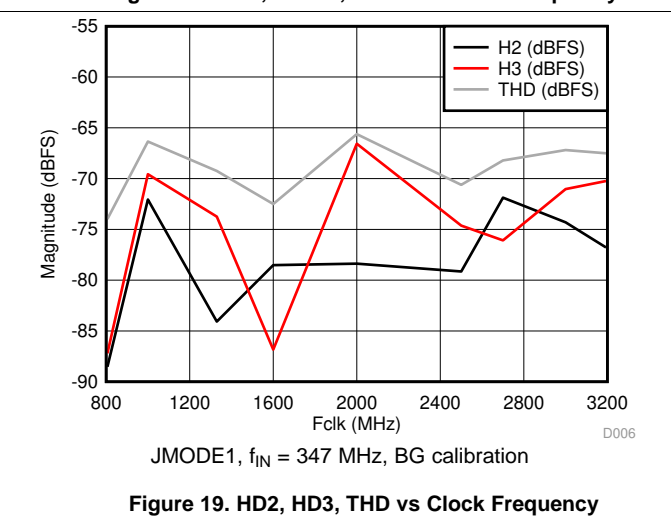

Figure 19. HD2, HD3, THD vs Clock Frequency

### Typical Characteristics (continued)

typical values at  $T_A = 25^\circ\text{C}$ ,  $V_{A19} = 1.9\text{ V}$ ,  $V_{A11} = V_{D11} = 1.1\text{ V}$ , default full-scale voltage ( $\text{FS\_RANGE\_A} = \text{FS\_RANGE\_B} = 0\text{x}A000$ ), input signal applied to  $\text{INA}\pm$  in single-channel modes,  $f_{\text{IN}} = 347\text{ MHz}$ ,  $A_{\text{IN}} = -1\text{ dBFS}$ ,  $f_{\text{CLK}} =$  maximum-rated clock frequency, filtered,  $1\text{-}V_{\text{PP}}$  sine-wave clock,  $\text{JMODE} = 1$ , and background calibration (unless otherwise noted); SNR results exclude DC, HD2 to HD9 and interleaving spurs; SINAD, ENOB, and SFDR results exclude DC and fixed-frequency interleaving spurs

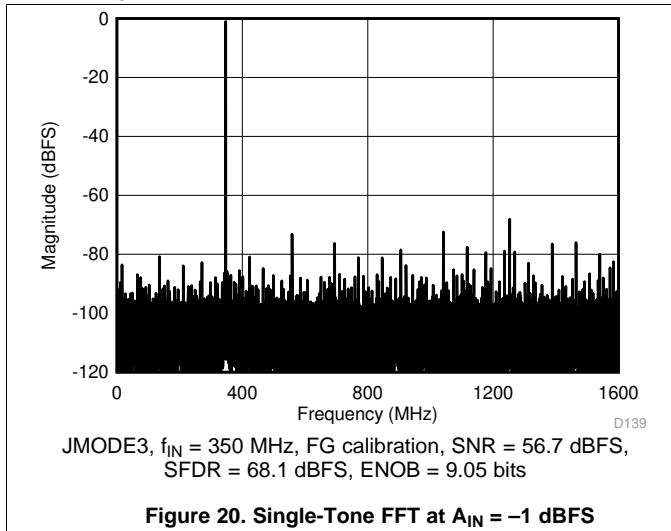

Figure 20. Single-Tone FFT at  $A_{\text{IN}} = -1\text{ dBFS}$

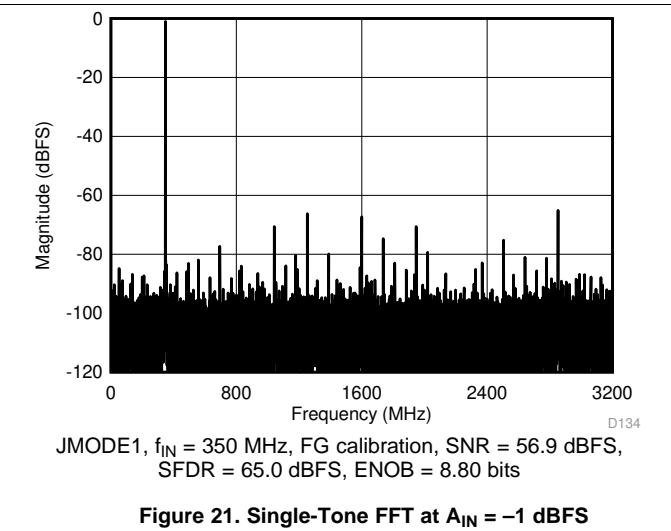

Figure 21. Single-Tone FFT at  $A_{\text{IN}} = -1\text{ dBFS}$

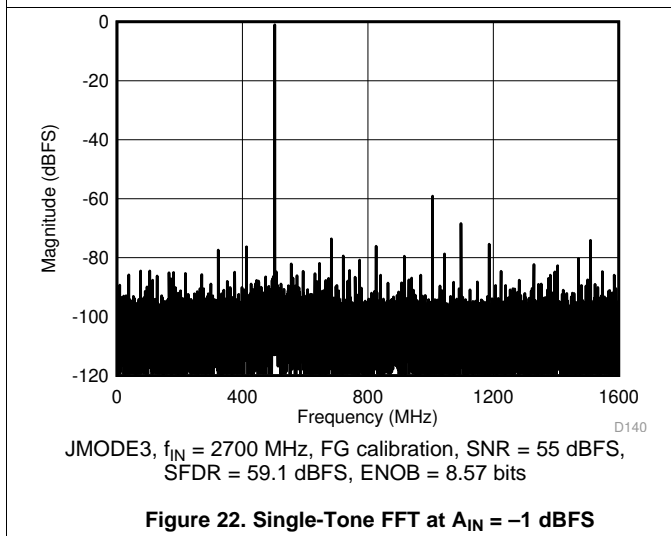

Figure 22. Single-Tone FFT at  $A_{\text{IN}} = -1\text{ dBFS}$

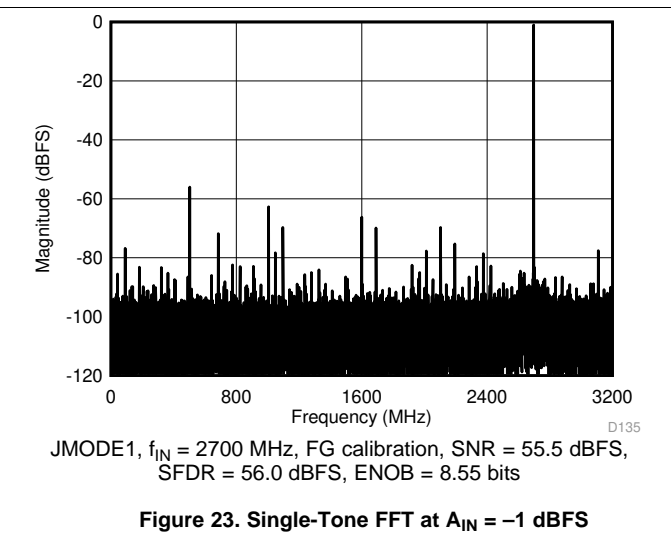
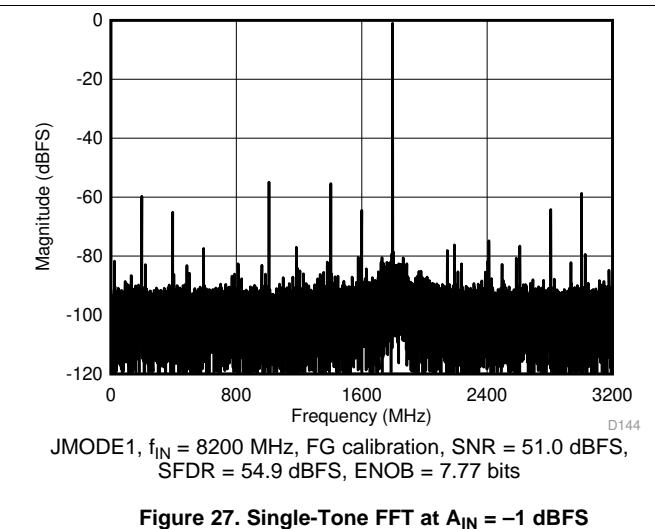
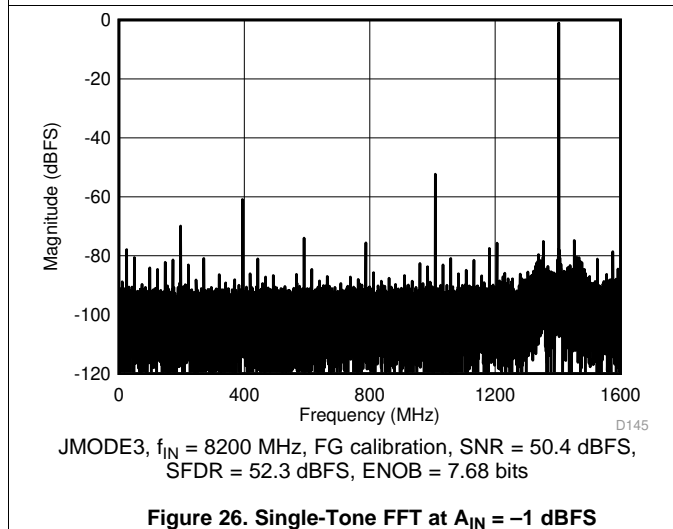
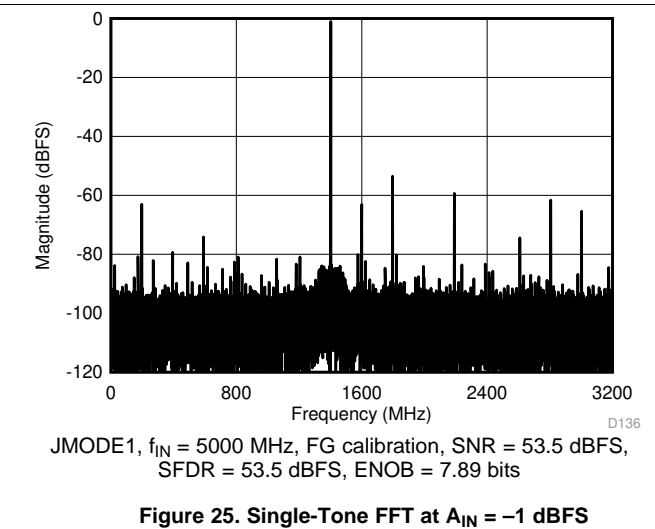
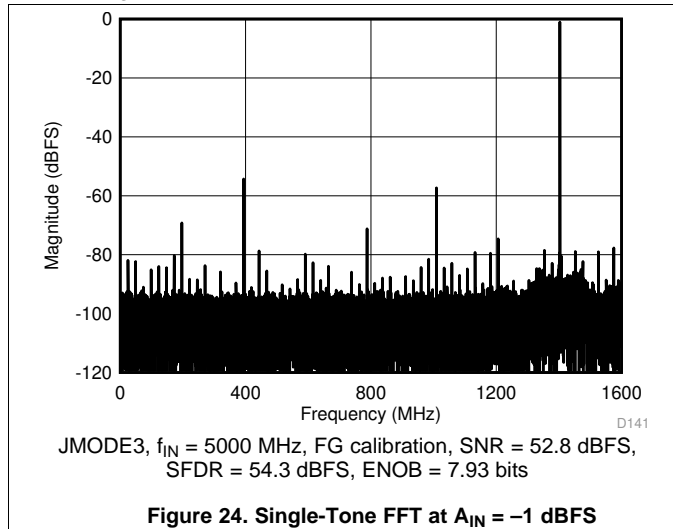

Figure 23. Single-Tone FFT at  $A_{\text{IN}} = -1\text{ dBFS}$

### Typical Characteristics (continued)

typical values at  $T_A = 25^\circ\text{C}$ ,  $V_{A19} = 1.9\text{ V}$ ,  $V_{A11} = V_{D11} = 1.1\text{ V}$ , default full-scale voltage ( $\text{FS\_RANGE\_A} = \text{FS\_RANGE\_B} = 0\text{x}A000$ ), input signal applied to  $\text{INA}\pm$  in single-channel modes,  $f_{\text{IN}} = 347\text{ MHz}$ ,  $A_{\text{IN}} = -1\text{ dBFS}$ ,  $f_{\text{CLK}} =$  maximum-rated clock frequency, filtered,  $1\text{-}V_{\text{PP}}$  sine-wave clock,  $\text{JMODE} = 1$ , and background calibration (unless otherwise noted); SNR results exclude DC, HD2 to HD9 and interleaving spurs; SINAD, ENOB, and SFDR results exclude DC and fixed-frequency interleaving spurs



### Typical Characteristics (continued)

typical values at  $T_A = 25^\circ\text{C}$ ,  $V_{A19} = 1.9\text{ V}$ ,  $V_{A11} = V_{D11} = 1.1\text{ V}$ , default full-scale voltage ( $\text{FS\_RANGE\_A} = \text{FS\_RANGE\_B} = 0\text{x}A000$ ), input signal applied to  $\text{INA}\pm$  in single-channel modes,  $f_{\text{IN}} = 347\text{ MHz}$ ,  $A_{\text{IN}} = -1\text{ dBFS}$ ,  $f_{\text{CLK}} =$  maximum-rated clock frequency, filtered,  $1\text{-}V_{\text{PP}}$  sine-wave clock,  $\text{JMODE} = 1$ , and background calibration (unless otherwise noted); SNR results exclude DC, HD2 to HD9 and interleaving spurs; SINAD, ENOB, and SFDR results exclude DC and fixed-frequency interleaving spurs

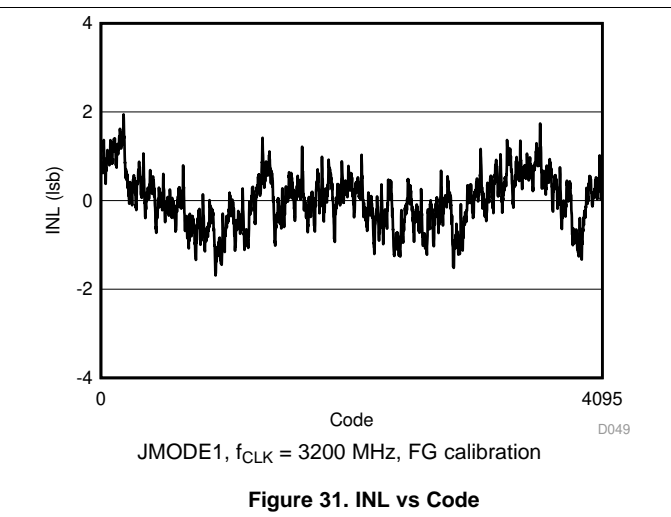
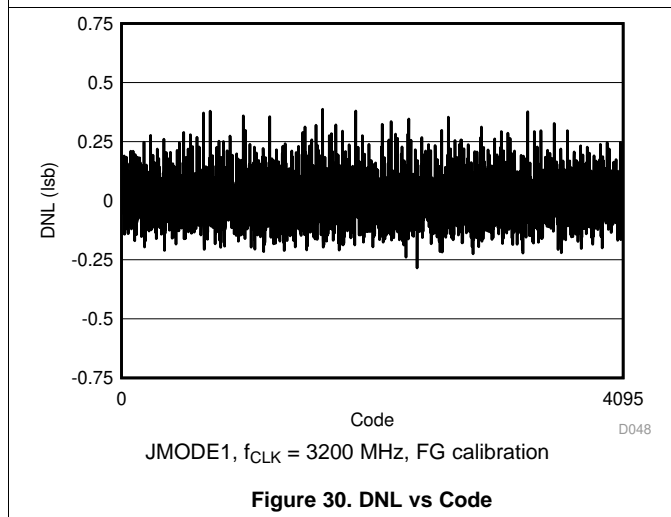
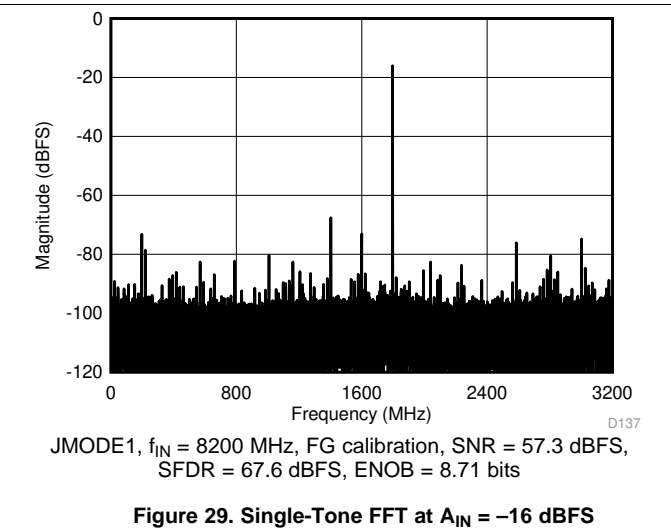
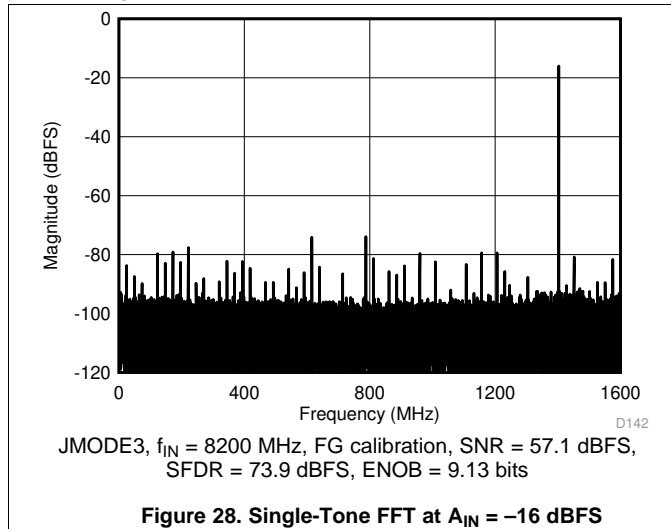

Typical Characteristics (continued)

typical values at  $T_A = 25^\circ\text{C}$ ,  $V_{A19} = 1.9\text{ V}$ ,  $V_{A11} = V_{D11} = 1.1\text{ V}$ , default full-scale voltage ( $\text{FS\_RANGE\_A} = \text{FS\_RANGE\_B} = 0x\text{A000}$ ), input signal applied to  $\text{INA}\pm$  in single-channel modes,  $f_{\text{IN}} = 347\text{ MHz}$ ,  $A_{\text{IN}} = -1\text{ dBFS}$ ,  $f_{\text{CLK}} =$  maximum-rated clock frequency, filtered,  $1\text{-}V_{\text{PP}}$  sine-wave clock,  $\text{JMODE} = 1$ , and background calibration (unless otherwise noted); SNR results exclude DC, HD2 to HD9 and interleaving spurs; SINAD, ENOB, and SFDR results exclude DC and fixed-frequency interleaving spurs

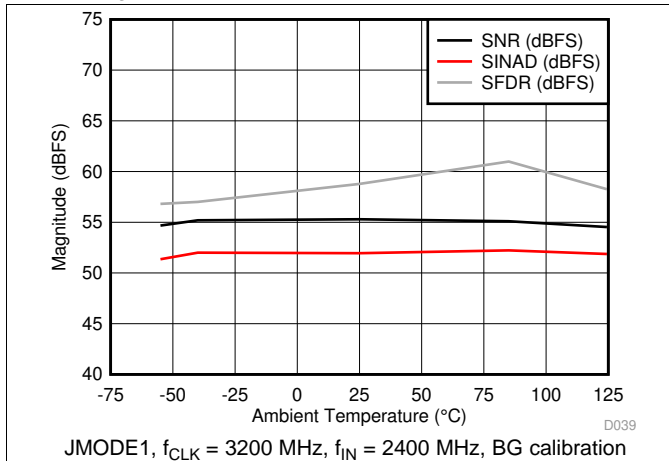

Figure 32. SNR, SINAD, SFDR vs Temperature

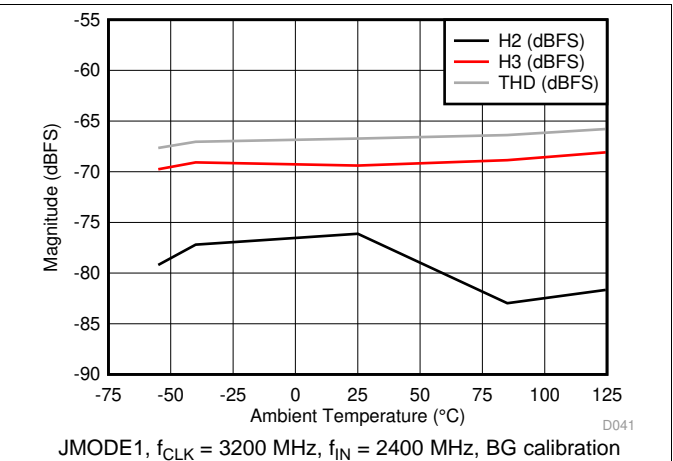

Figure 33. HD2, HD3, THD vs Temperature

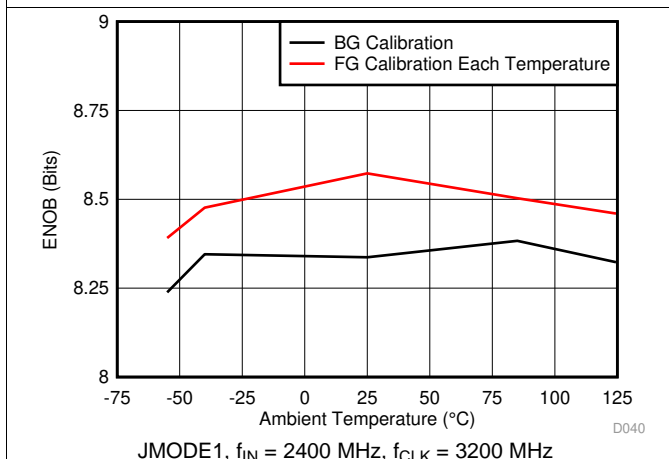

Figure 34. ENOB vs Temperature and Calibration Type

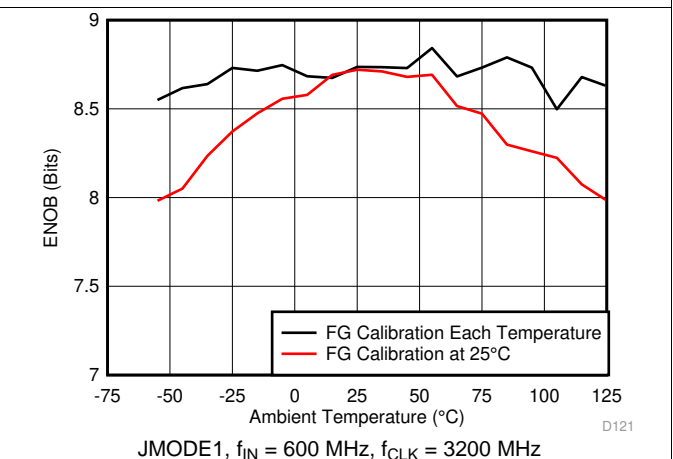

Figure 35. ENOB vs Temperature and Calibration Type

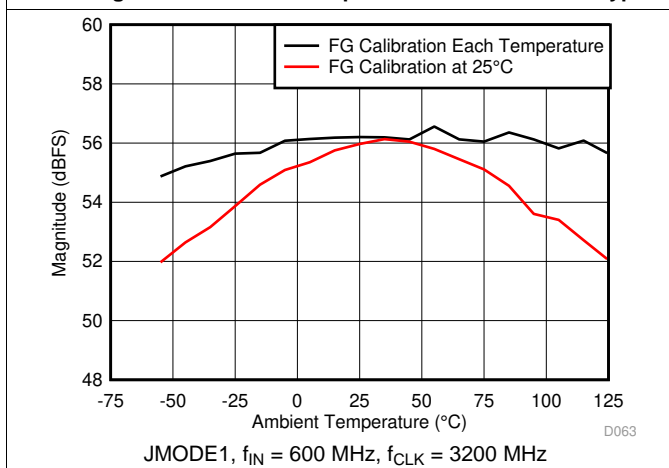

Figure 36. SNR vs Temperature and Calibration Type

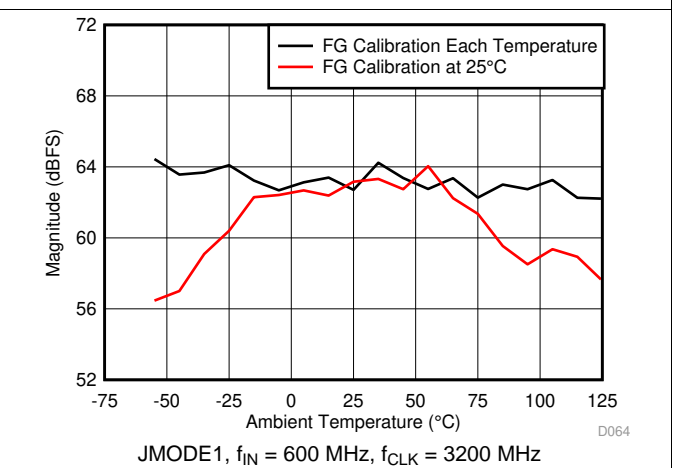

Figure 37. SFDR vs Temperature and Calibration Type

Typical Characteristics (continued)

typical values at  $T_A = 25^\circ\text{C}$ ,  $V_{A19} = 1.9\text{ V}$ ,  $V_{A11} = V_{D11} = 1.1\text{ V}$ , default full-scale voltage ( $\text{FS\_RANGE\_A} = \text{FS\_RANGE\_B} = 0x\text{A000}$ ), input signal applied to  $\text{INA}\pm$  in single-channel modes,  $f_{\text{IN}} = 347\text{ MHz}$ ,  $A_{\text{IN}} = -1\text{ dBFS}$ ,  $f_{\text{CLK}} =$  maximum-rated clock frequency, filtered,  $1\text{-}V_{\text{PP}}$  sine-wave clock,  $\text{JMODE} = 1$ , and background calibration (unless otherwise noted); SNR results exclude DC, HD2 to HD9 and interleaving spurs; SINAD, ENOB, and SFDR results exclude DC and fixed-frequency interleaving spurs

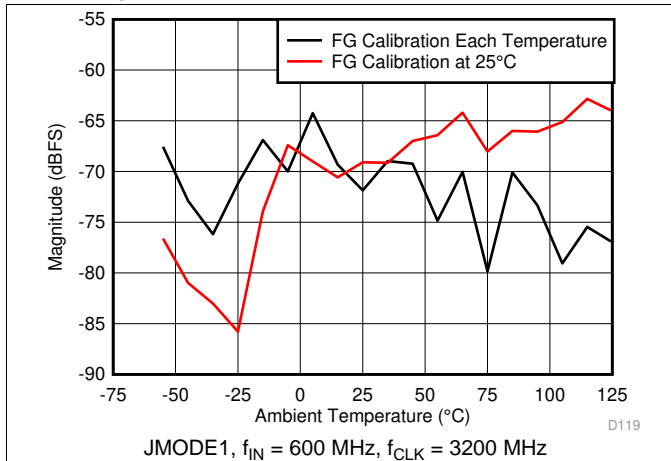

Figure 38. HD2 vs Temperature and Calibration Type

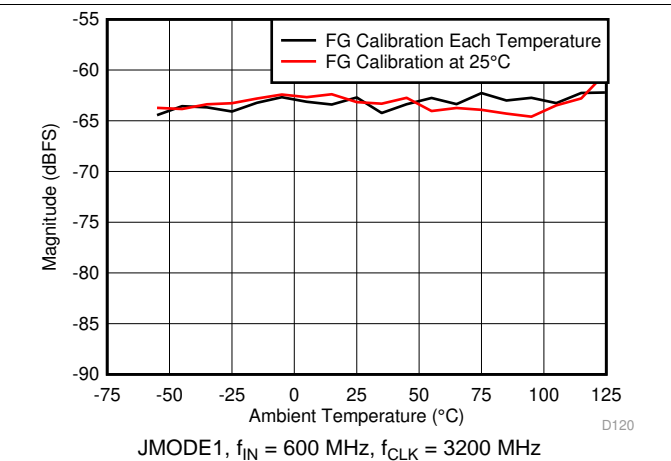

Figure 39. HD3 vs Temperature and Calibration Type

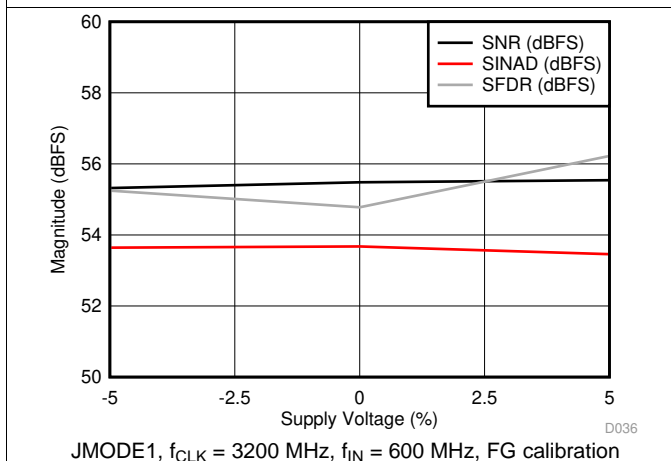

Figure 40. SNR, SINAD, SFDR vs Supply Voltage

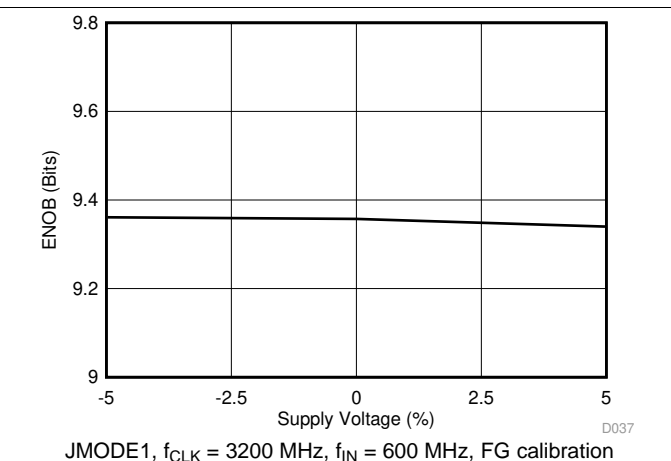

Figure 41. ENOB vs Supply Voltage

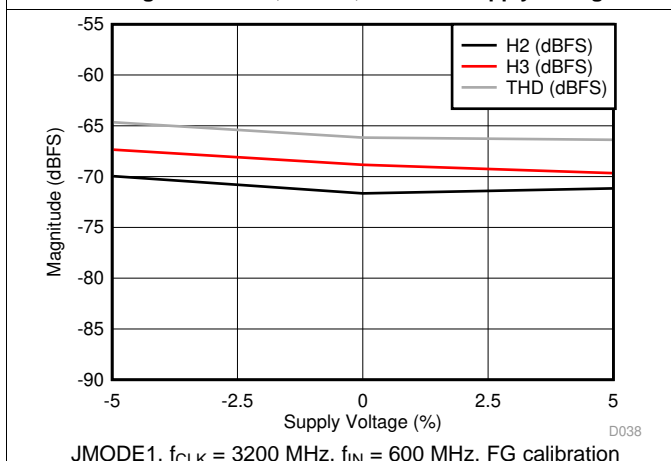

Figure 42. HD2, HD3, THD vs Supply Voltage

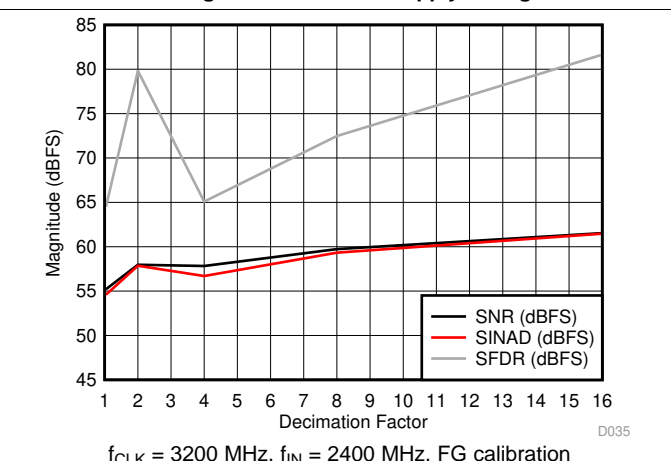

Figure 43. SNR, SINAD, SFDR vs Decimation Factor



Typical Characteristics (continued)

typical values at  $T_A = 25^\circ\text{C}$ ,  $V_{A19} = 1.9\text{ V}$ ,  $V_{A11} = V_{D11} = 1.1\text{ V}$ , default full-scale voltage ( $\text{FS\_RANGE\_A} = \text{FS\_RANGE\_B} = 0x\text{A000}$ ), input signal applied to  $\text{INA}\pm$  in single-channel modes,  $f_{\text{IN}} = 347\text{ MHz}$ ,  $A_{\text{IN}} = -1\text{ dBFS}$ ,  $f_{\text{CLK}} =$  maximum-rated clock frequency, filtered,  $1\text{-}V_{\text{PP}}$  sine-wave clock,  $\text{JMODE} = 1$ , and background calibration (unless otherwise noted); SNR results exclude DC, HD2 to HD9 and interleaving spurs; SINAD, ENOB, and SFDR results exclude DC and fixed-frequency interleaving spurs

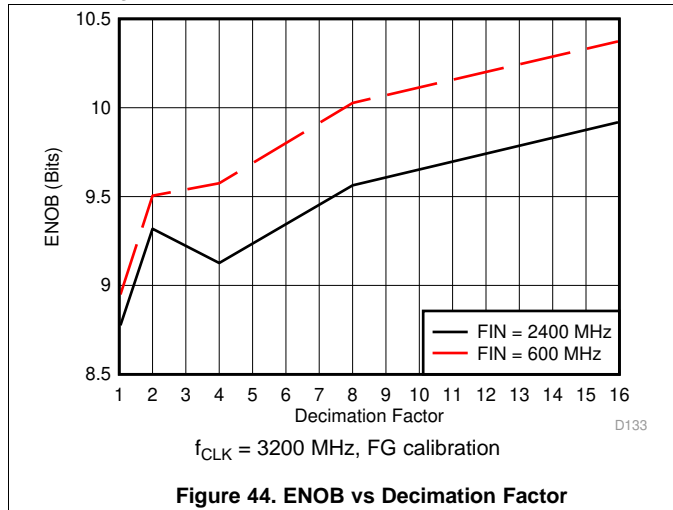

Figure 44. ENOB vs Decimation Factor

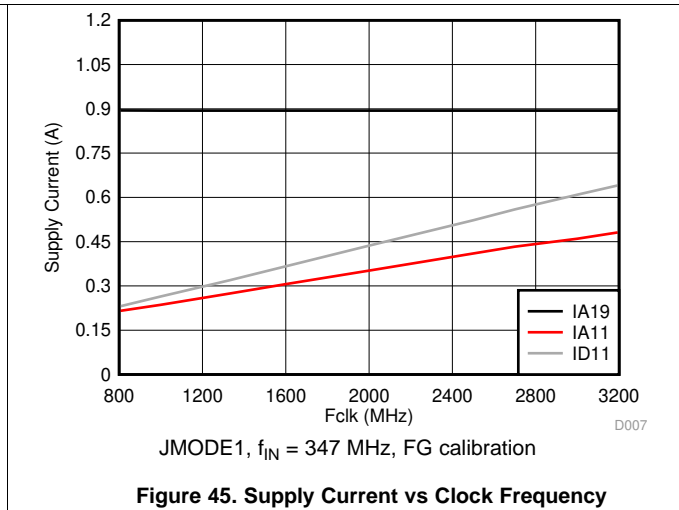

Figure 45. Supply Current vs Clock Frequency

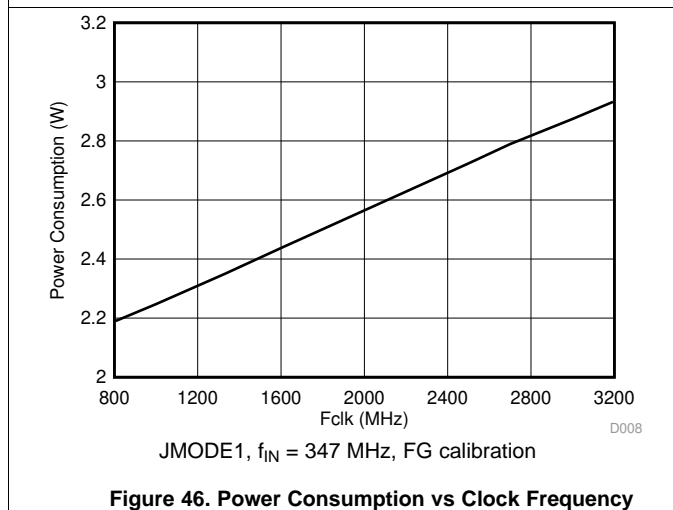

Figure 46. Power Consumption vs Clock Frequency

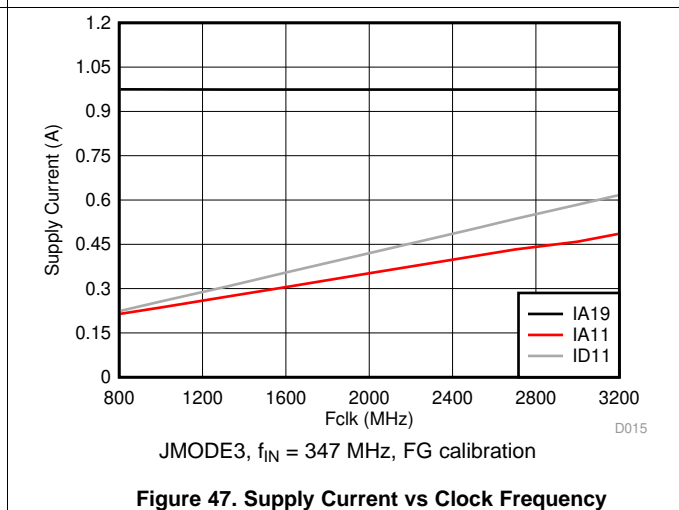

Figure 47. Supply Current vs Clock Frequency

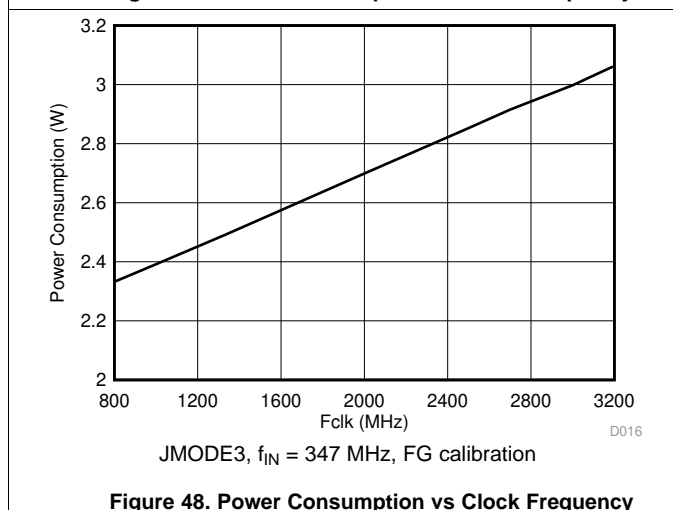

Figure 48. Power Consumption vs Clock Frequency

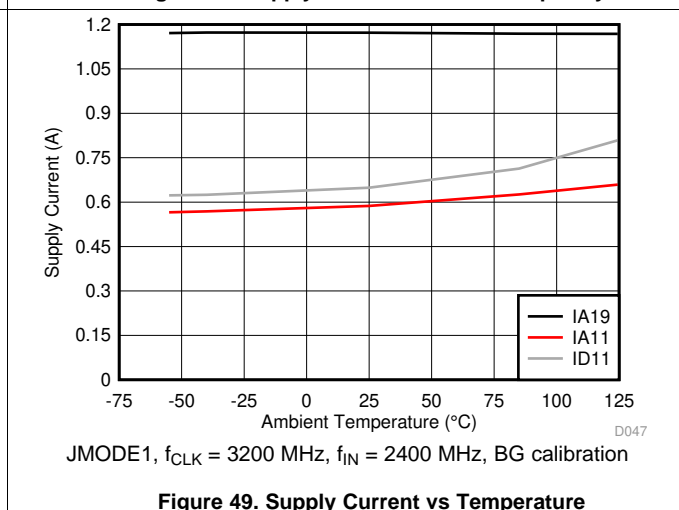
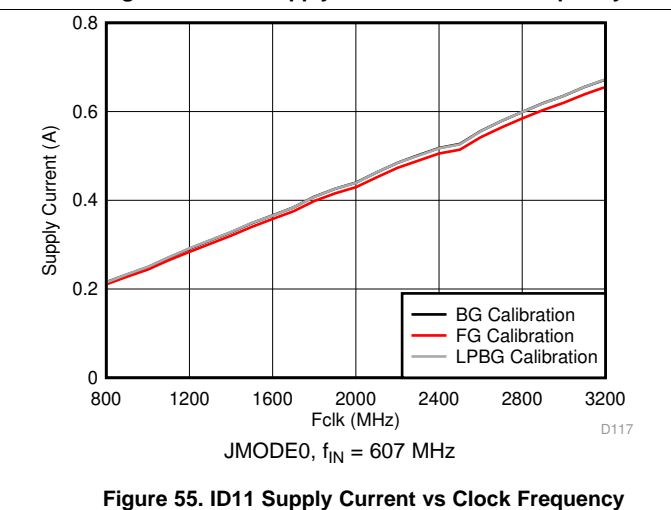
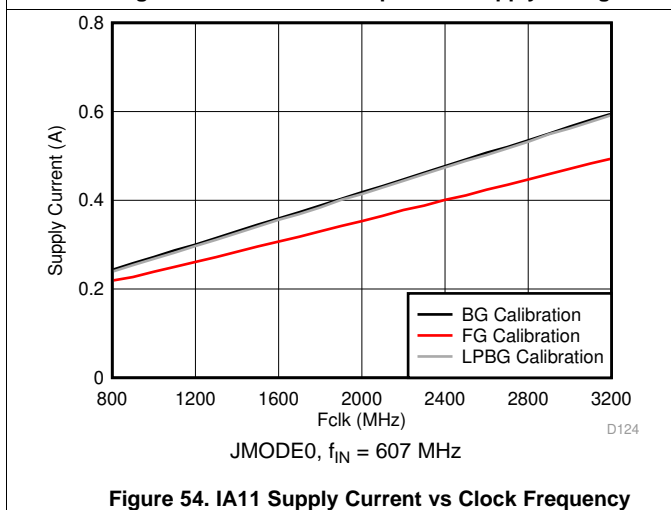
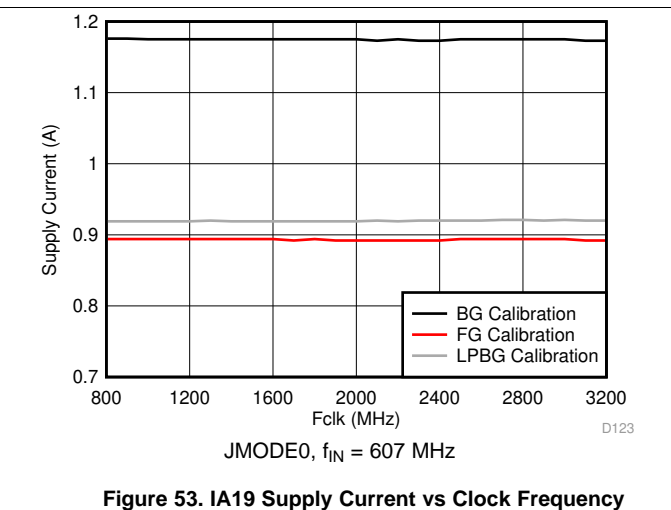
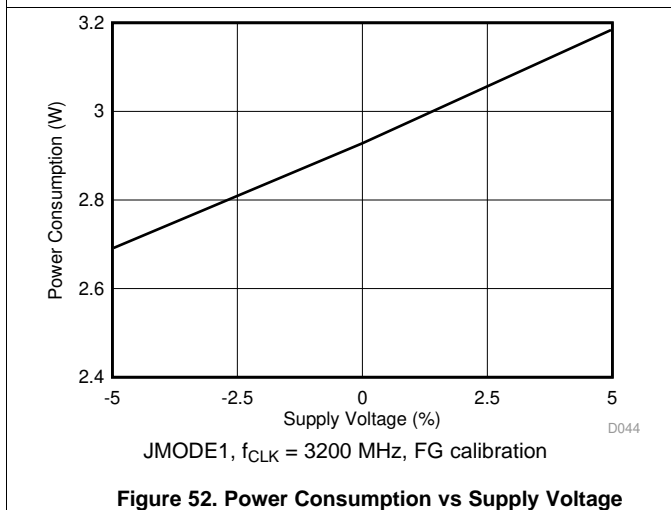
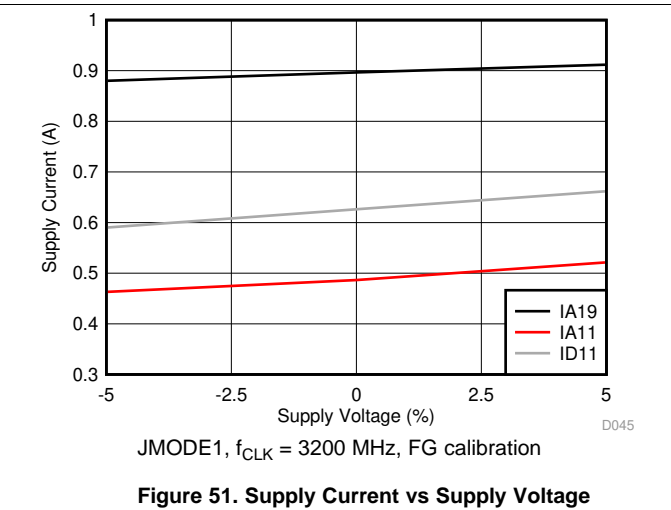
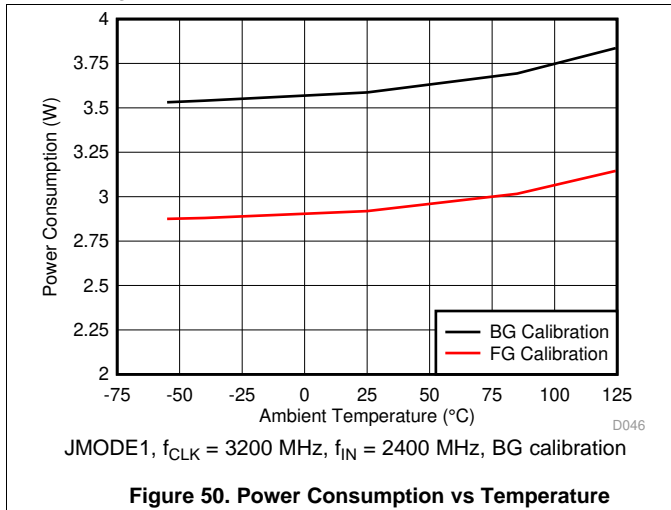

Figure 49. Supply Current vs Temperature

### Typical Characteristics (continued)

typical values at  $T_A = 25^\circ\text{C}$ ,  $V_{A19} = 1.9\text{ V}$ ,  $V_{A11} = V_{D11} = 1.1\text{ V}$ , default full-scale voltage ( $\text{FS\_RANGE\_A} = \text{FS\_RANGE\_B} = 0\text{x}A000$ ), input signal applied to  $\text{INA}\pm$  in single-channel modes,  $f_{\text{IN}} = 347\text{ MHz}$ ,  $A_{\text{IN}} = -1\text{ dBFS}$ ,  $f_{\text{CLK}} =$  maximum-rated clock frequency, filtered,  $1\text{-}V_{\text{PP}}$  sine-wave clock,  $\text{JMODE} = 1$ , and background calibration (unless otherwise noted); SNR results exclude DC, HD2 to HD9 and interleaving spurs; SINAD, ENOB, and SFDR results exclude DC and fixed-frequency interleaving spurs



### Typical Characteristics (continued)

typical values at  $T_A = 25^\circ\text{C}$ ,  $V_{A19} = 1.9\text{ V}$ ,  $V_{A11} = V_{D11} = 1.1\text{ V}$ , default full-scale voltage ( $\text{FS\_RANGE\_A} = \text{FS\_RANGE\_B} = 0\text{x}A000$ ), input signal applied to  $\text{INA}\pm$  in single-channel modes,  $f_{\text{IN}} = 347\text{ MHz}$ ,  $A_{\text{IN}} = -1\text{ dBFS}$ ,  $f_{\text{CLK}} =$  maximum-rated clock frequency, filtered,  $1\text{-}V_{\text{PP}}$  sine-wave clock,  $\text{JMODE} = 1$ , and background calibration (unless otherwise noted); SNR results exclude DC, HD2 to HD9 and interleaving spurs; SINAD, ENOB, and SFDR results exclude DC and fixed-frequency interleaving spurs

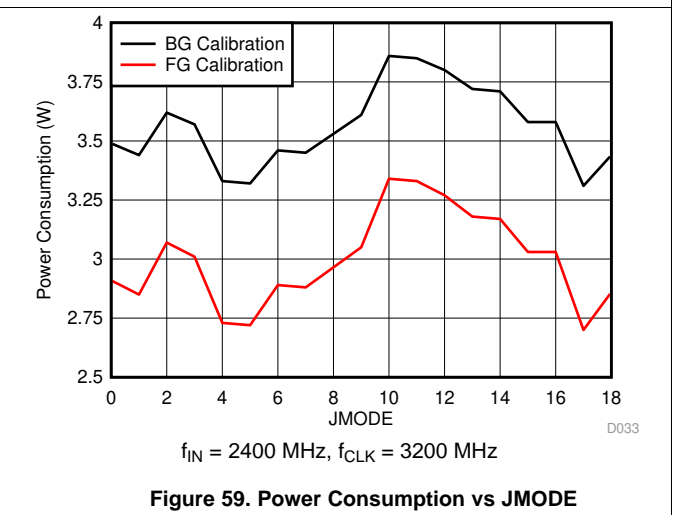
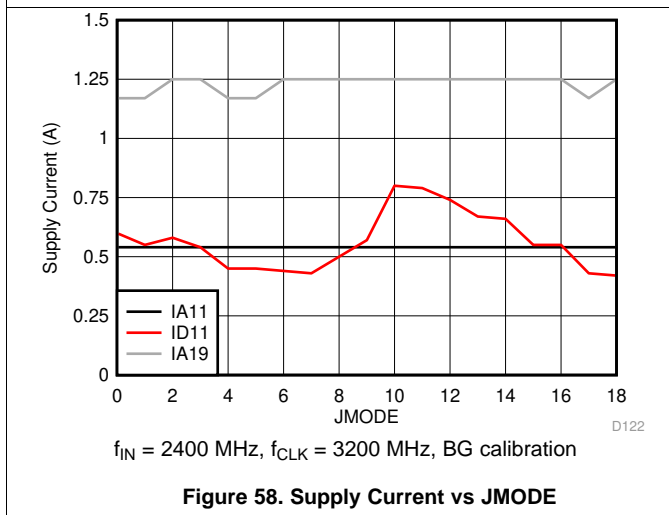
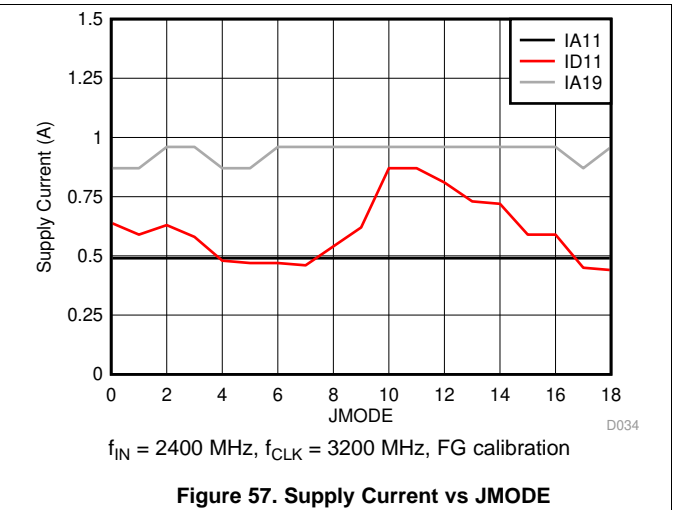
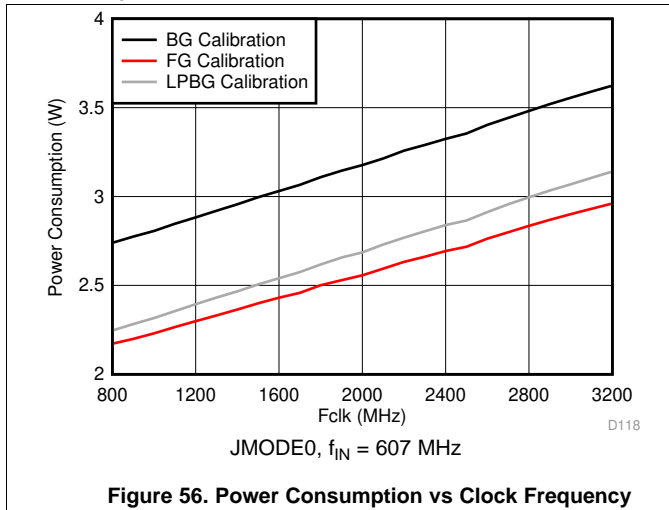

### Typical Characteristics (continued)

typical values at  $T_A = 25^\circ\text{C}$ ,  $V_{A19} = 1.9\text{ V}$ ,  $V_{A11} = V_{D11} = 1.1\text{ V}$ , default full-scale voltage ( $\text{FS\_RANGE\_A} = \text{FS\_RANGE\_B} = 0\text{x}A000$ ), input signal applied to  $\text{INA}\pm$  in single-channel modes,  $f_{\text{IN}} = 347\text{ MHz}$ ,  $A_{\text{IN}} = -1\text{ dBFS}$ ,  $f_{\text{CLK}} =$  maximum-rated clock frequency, filtered,  $1\text{-}V_{\text{PP}}$  sine-wave clock,  $\text{JMODE} = 1$ , and background calibration (unless otherwise noted); SNR results exclude DC, HD2 to HD9 and interleaving spurs; SINAD, ENOB, and SFDR results exclude DC and fixed-frequency interleaving spurs

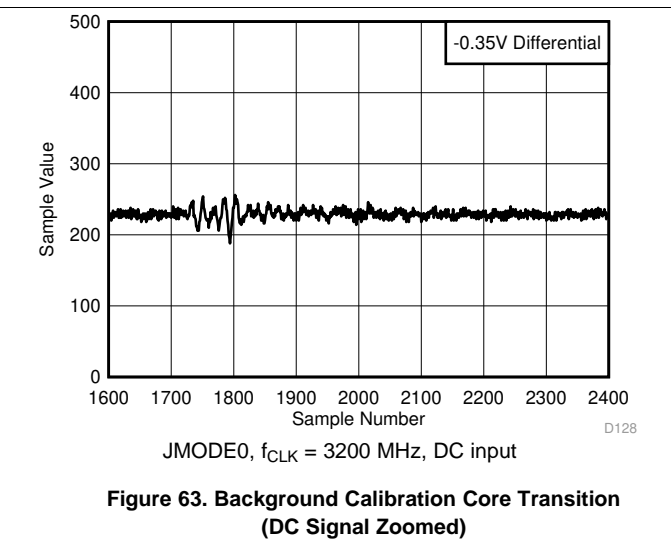
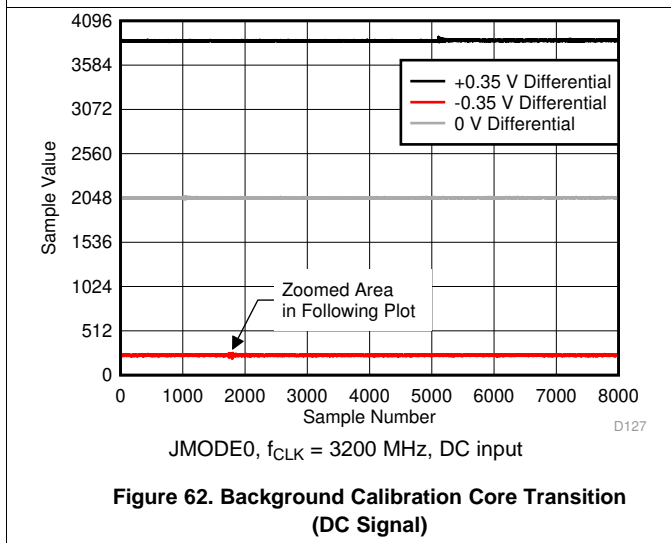
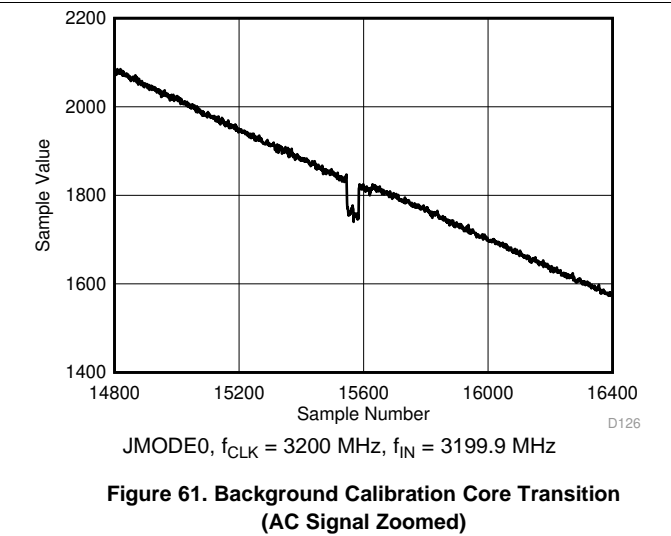
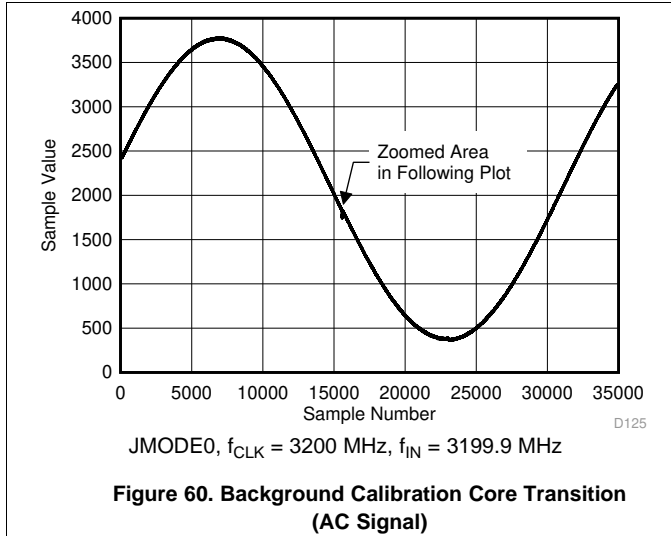

## 7 Detailed Description

### 7.1 Overview

ADC12DJ3200 device is an RF-sampling, giga-sample, analog-to-digital converter (ADC) that can directly sample input frequencies from DC to above 10 GHz. In dual-channel mode, the ADC12DJ3200 can sample up to 3200 GSPS and up to 6400 GSPS in single-channel mode. Programmable tradeoffs in channel count (dual-channel mode) and Nyquist bandwidth (single-channel mode) allow development of flexible hardware that meets the needs of both high channel count or wide instantaneous signal bandwidth applications. Full-power input bandwidth ( $-3$  dB) of 8.0 GHz, with usable frequencies exceeding the  $-3$ -dB point in both dual- and single-channel modes, allows direct RF sampling of L-band, S-band, C-band, and X-band for frequency agile systems.

ADC12DJ3200 uses a high-speed JESD204B output interface with up to 16 serialized lanes and subclass-1 compliance for deterministic latency and multi-device synchronization. The serial output lanes support up to 12.8 Gbps and can be configured to trade-off bit rate and number of lanes.

A number of synchronization features, including noiseless aperture delay ( $t_{AD}$ ) adjustment and SYSREF windowing, simplify system design for multi-channel systems. Aperture delay adjustment can be used to simplify SYSREF capture, to align the sampling instance between multiple ADCs or to sample an ideal location of a front-end track and hold (T&H) amplifier output. SYSREF windowing offers a simplistic way to measure invalid timing regions of SYSREF relative to the device clock and then choose an optimal sampling location. Dual-edge sampling (DES) is implemented in single-channel mode to reduce the maximum clock rate applied to the ADC to support a wide range of clock sources and relax setup and hold timing for SYSREF capture.

Optional digital down converters (DDCs) are available in dual-channel mode to allow a reduction in interface rate (decimation) and digital mixing of the signal to baseband. The DDC block supports data decimation of 4x, 8x or 16x and alias-free complex output bandwidths of 80% of the effective output data rate.

ADC12DJ3200 provides foreground and background calibration options for gain, offset and static linearity errors. Foreground calibration is run at system startup or at specified times during which the ADC is offline and not sending data to the logic device. Background calibration allows the ADC to run continually while the cores are calibrated in the background so that the system does not experience downtime. The calibration routine is also used to match the gain and offset between sub-ADC cores to minimize spurious artifacts from time interleaving.

## 7.2 Functional Block Diagram

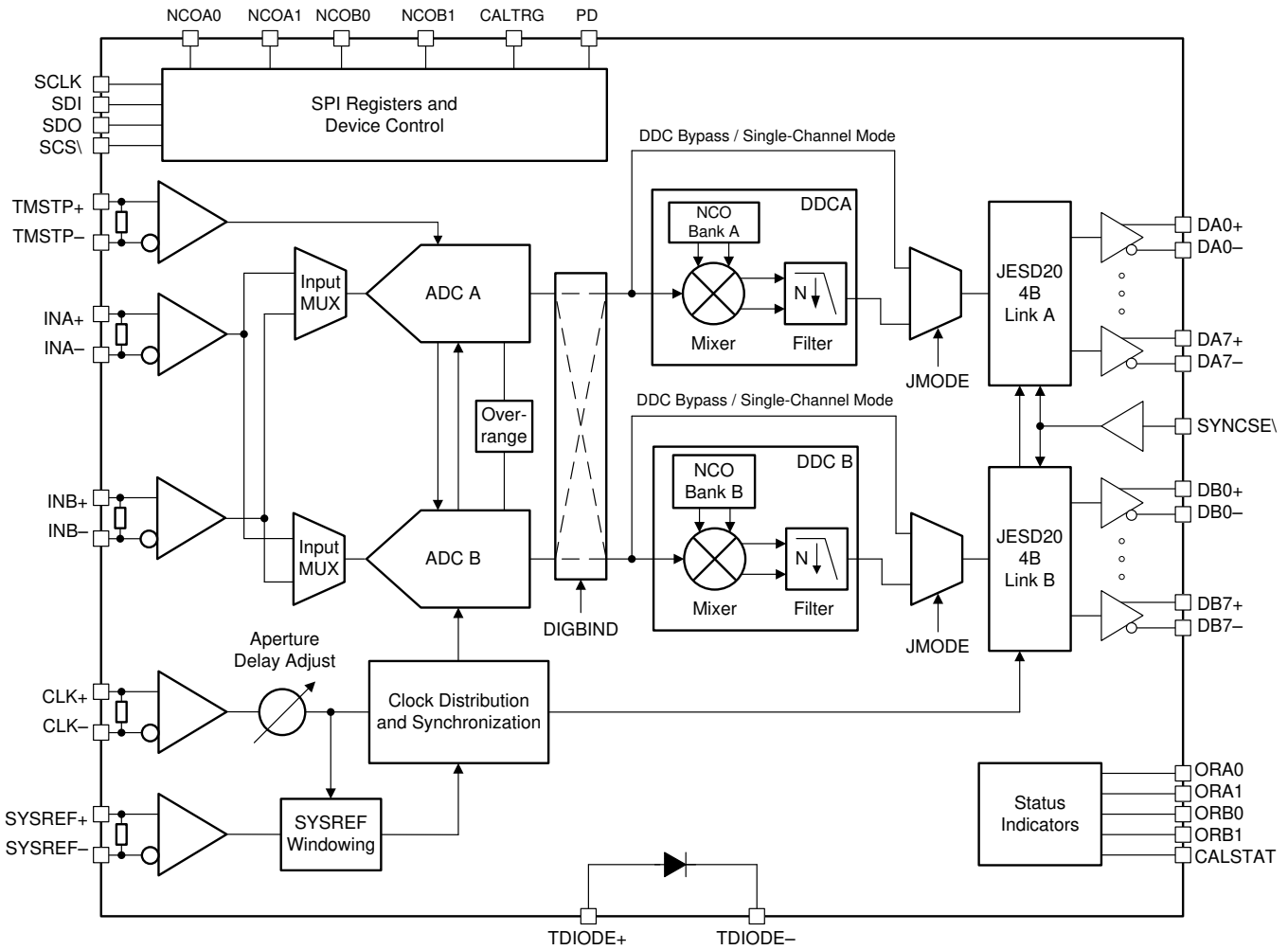

## 7.3 Feature Description

### 7.3.1 Device Comparison

The devices listed in [表 1](#) are part of a pin-to-pin compatible, high-speed, wide-bandwidth ADC family. The family is offered to provide a scalable family of devices for varying resolution, sampling rate and signal bandwidth.

表 1. Device Family Comparison

PART NUMBER	MAXIMUM SAMPLING RATE	RESOLUTION	DUAL CHANNEL DECIMATION	SINGLE CHANNEL DECIMATION	INTERFACE (MAX LINERATE)
ADC12DJ5200RF	Single 10.4 GSPS Dual 5.2 GSPS	12-bit	Complex: 4x, 8x	Complex: 4x, 8x	JESD204B / JESD204C (17.16 Gbps)
ADC12DJ3200	Single 6.4 GSPS Dual 3.2 GSPS	12-bit	Real: 2x Complex: 4x, 8x, 16x	None	JESD204B (12.8 Gbps)
ADC08DJ3200	Single 6.4 GSPS Dual 3.2 GSPS	8-bit	None	None	JESD204B (12.8 Gbps)
ADC12DJ2700	Single 5.4 GSPS Dual 2.7 GSPS	12-bit	Real: 2x Complex: 4x, 8x, 16x	None	JESD204B (12.8 Gbps)

### 7.3.2 Analog Inputs

The analog inputs of the ADC12DJ3200 have internal buffers to enable high input bandwidth and to isolate sampling capacitor glitch noise from the input circuit. Analog inputs must be driven differentially because operation with a single-ended signal results in degraded performance. Both AC-coupling and DC-coupling of the analog inputs is supported. The analog inputs are designed for an input common-mode voltage ( $V_{\text{CMI}}$ ) of 0 V, which is terminated internally through single-ended, 50- $\Omega$  resistors to ground (GND) on each input pin. DC-coupled input signals must have a common-mode voltage that meets the device input common-mode requirements specified as  $V_{\text{CMI}}$  in the [Recommended Operating Conditions](#) table. The 0-V input common-mode voltage simplifies the interface to split-supply, fully-differential amplifiers and to a variety of transformers and baluns. The ADC12DJ3200 includes internal analog input protection to protect the ADC inputs during overranged input conditions; see the [Analog Input Protection](#) section. 图 64 provides a simplified analog input model.



图 64. ADC12DJ3200 Analog Input Internal Termination and Protection Diagram

There is minimal degradation in analog input bandwidth when using single-channel mode versus dual-channel mode. In single-channel mode,  $\text{INA}_{\pm}$  is strongly recommended to be used as the input to the ADC because ADC performance is optimized for  $\text{INA}_{\pm}$ . However, either analog input ( $\text{INA}_{+}$  and  $\text{INA}_{-}$  or  $\text{INB}_{+}$  and  $\text{INB}_{-}$ ) can be used. Using  $\text{INB}_{\pm}$  results in degraded performance unless custom trim routines are used to optimize performance for  $\text{INB}_{\pm}$  in each device. The desired input can be chosen using `SINGLE_INPUT` in the [input mux control register](#).

注

$\text{INA}_{\pm}$  is strongly recommended to be used as the input to the ADC in single-channel mode for optimized performance.

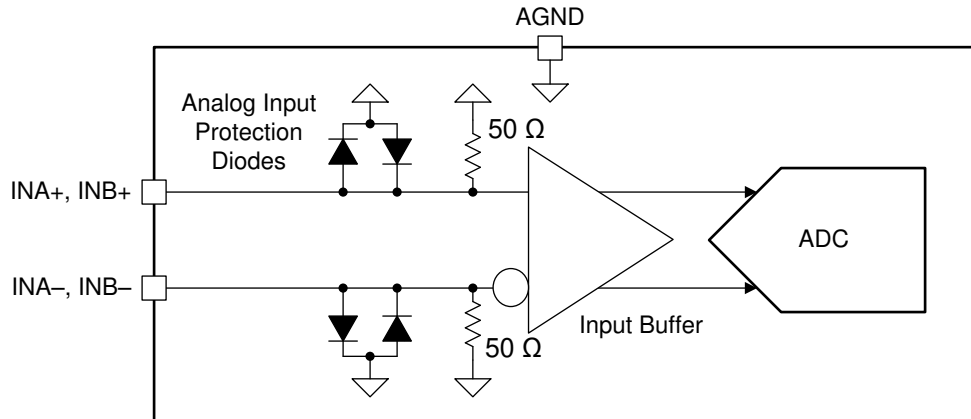
#### 7.3.2.1 Analog Input Protection

The analog inputs are protected against overdrive conditions by internal clamping diodes that are capable of sourcing or sinking input currents during overrange conditions, see the voltage and current limits in the [Absolute Maximum Ratings](#) table. The overrange protection is also defined for a peak RF input power in the [Absolute Maximum Ratings](#) table, which is frequency independent. Operation above the maximum conditions listed in the [Recommended Operating Conditions](#) table results in an increase in failure-in-time (FIT) rate, so the system must correct the overdrive condition as quickly as possible. 图 64 shows the analog input protection diodes.

#### 7.3.2.2 Full-Scale Voltage ( $V_{\text{FS}}$ ) Adjustment

Input full-scale voltage ( $V_{\text{FS}}$ ) adjustment is available, in fine increments, for each analog input through the `FS_RANGE_A` register setting (see the [INA full-scale range adjust register](#)) and `FS_RANGE_B` register setting (see the [INB full-scale range adjust register](#)) for  $\text{INA}_{\pm}$  and  $\text{INB}_{\pm}$ , respectively. The available adjustment range is specified in the [Electrical Characteristics - DC Specifications](#) table. Larger full-scale voltages improve SNR and noise floor (in dBFS/Hz) performance, but may degrade harmonic distortion. The full-scale voltage adjustment is useful for matching the full-scale range of multiple ADCs when developing a multi-converter system or for external interleaving of multiple ADC12DJ3200s to achieve higher sampling rates.



### 7.3.2.3 Analog Input Offset Adjust

The input offset voltage for each input can be adjusted through the SPI register. The OADJ\_A\_INx registers (registers 0x08A and 0x08D) are used to adjust ADC core A's offset voltage when sampling analog input x (where x is A for INA± or B for INB±). OADJ\_B\_INx is used to adjust ADC core B's offset voltage when sampling input x. These registers apply to both dual channel mode and single channel mode. To adjust the offset voltage in dual channel mode simply adjust the offset to the ADC core sampling the desired input. In single channel mode, both ADC core A's and ADC core B's offset must be adjusted together. The difference in the two core's offsets in single channel mode results in a spur at  $f_s/2$  that is independent of the input. These registers can be used to compensate the  $f_s/2$  spur in single channel mode. See the [Calibration Modes and Trimming](#) section for more information.

## 7.3.3 ADC Core

The ADC12DJ3200 consists of a total of six ADC cores. The cores are interleaved for higher sampling rates and swapped on-the-fly for calibration as required by the operating mode. This section highlights the theory and key features of the ADC cores.

### 7.3.3.1 ADC Theory of Operation

The differential voltages at the analog inputs are captured by the rising edge of  $CLK_{\pm}$  in dual-channel mode or by the rising and falling edges of  $CLK_{\pm}$  in single-channel mode. After capturing the input signal, the ADC converts the analog voltage to a digital value by comparing the voltage to the internal reference voltage. If the voltage on INA– or INB– is higher than the voltage on INA+ or INB+, respectively, then the digital output is a negative 2's complement value. If the voltage on INA+ or INB+ is higher than the voltage on INA– or INB–, respectively, then the digital output is a positive 2's complement value. [公式 1](#) can calculate the differential voltage at the input pins from the digital output.

$$V_{IN} = \frac{\text{Code}}{2^N} V_{FS}$$

where

- Code is the signed decimation output code (for example, –2048 to +2047)
  - N is the ADC resolution
  - and  $V_{FS}$  is the full-scale input voltage of the ADC as specified in the [Recommended Operating Conditions](#) table, including any adjustment performed by programming FS\_RANGE\_A or FS\_RANGE\_B
- (1)

### 7.3.3.2 ADC Core Calibration

ADC core calibration is required to optimize the analog performance of the ADC cores. Calibration must be repeated when operating conditions change significantly, namely temperature, in order to maintain optimal performance. The ADC12DJ3200 has a built-in calibration routine that can be run as a foreground operation or a background operation. Foreground operation requires ADC downtime, where the ADC is no longer sampling the input signal, to complete the process. Background calibration can be used to overcome this limitation and allow constant operation of the ADC. See the [Calibration Modes and Trimming](#) section for detailed information on each mode.

### 7.3.3.3 Analog Reference Voltage

The reference voltage for the ADC12DJ3200 is derived from an internal band-gap reference. A buffered version of the reference voltage is available at the BG pin for user convenience. This output has an output-current capability of  $\pm 100 \mu\text{A}$ . The BG output must be buffered if more current is required. No provision exists for the use of an external reference voltage, but the full-scale input voltage can be adjusted through the full-scale-range register settings. In unique cases, the VA11 supply voltage can act as the reference voltage by setting BG\_BYPASS (see the [internal reference bypass register](#)).

### 7.3.3.4 ADC Overrange Detection

To ensure that system gain management has the quickest possible response time, a low-latency configurable overrange function is included. The overrange function works by monitoring the converted 12-bit samples at the ADC to quickly detect if the ADC is near saturation or already in an overrange condition. The absolute value of the upper 8 bits of the ADC data are checked against two programmable thresholds, OVR\_T0 and OVR\_T1. These thresholds apply to both channel A and channel B in dual-channel mode. 表 2 lists how an ADC sample is converted to an absolute value for a comparison of the thresholds.

**表 2. Conversion of ADC Sample for Overrange Comparison**

ADC SAMPLE (Offset Binary)	ADC SAMPLE (2's Complement)	ABSOLUTE VALUE	UPPER 8 BITS USED FOR COMPARISON
1111 1111 1111 (4095)	0111 1111 1111 (+2047)	111 1111 1111 (2047)	1111 1111 (255)
1111 1111 0000 (4080)	0111 1111 0000 (+2032)	111 1111 0000 (2032)	1111 1110 (254)
1000 0000 0000 (2048)	0000 0000 0000 (0)	000 0000 0000 (0)	0000 0000 (0)
0000 0001 0000 (16)	1000 0001 0000 (-2032)	111 1111 0000 (2032)	1111 1110 (254)
0000 0000 0000 (0)	1000 0000 0000 (-2048)	111 1111 1111 (2047)	1111 1111 (255)

If the upper 8 bits of the absolute value equal or exceed the OVR\_T0 or OVR\_T1 thresholds during the monitoring period, then the overrange bit associated with the threshold is set to 1, otherwise the overrange bit is 0. In dual-channel mode, the overrange status can be monitored on the ORA0 and ORA1 pins for channel A and the ORB0 and ORB1 pins for channel B, where ORx0 corresponds to the OVR\_T0 threshold and ORx1 corresponds to the OVR\_T1 threshold. In single-channel mode, the overrange status for the OVR\_T0 threshold is determined by monitoring both the ORA0 and ORB0 outputs and the OVR\_T1 threshold is determined by monitoring both ORA1 and ORB1 outputs. In single-channel mode, the two outputs for each threshold must be OR'd together to determine whether an overrange condition occurred. OVR\_N can be used to set the output pulse duration from the last overrange event. 表 3 lists the overrange pulse lengths for the various OVR\_N settings (see the [overrange configuration register](#)). In decimation modes (only in the JMODEs where CS = 1 in 表 19), the overrange status is also embedded into the output data samples. For complex decimation modes, the OVR\_T0 threshold status is embedded as the LSB along with the upper 15 bits of every complex I sample and the OVR\_T1 threshold status is embedded as the LSB along with the upper 15 bits of every complex Q sample. For real decimation modes, the OVR\_T0 threshold status is embedded as the LSB of every even-numbered sample and the OVR\_T1 threshold status is embedded as the LSB of every odd-numbered sample. 表 4 lists the outputs, related data samples, threshold settings, and the monitoring period equation. The embedded overrange bit goes high if the associated channel exceeds the associated overrange threshold within the monitoring period set by OVR\_N. Use 表 4 to calculate the monitoring period.

**表 3. Overrange Monitoring Period for the ORA0, ORA1, ORB0, and ORB1 Outputs**

OVR_N	OVERRANGE PULSE LENGTH SINCE LAST OVERRANGE EVENT (DEVCLK Cycles)
0	8
1	16
2	32
3	64
4	128
5	256
6	512
7	1024

**表 4. Threshold and Monitoring Period for Embedded Overrange Indicators in Dual-Channel Decimation Modes**

OVERRANGE INDICATOR	ASSOCIATED THRESHOLD	DECIMATION TYPE	OVERRANGE STATUS EMBEDDED IN	MONITORING PERIOD (ADC Samples)
ORA0	OVR_T0	Real decimation (JMODE 9)	Channel A even-numbered samples	$2^{\text{OVR\_N}+1(1)}$
		Complex down-conversion (JMODE 10-16, except JMODE 12)	Channel A in-phase (I) samples	$2^{\text{OVR\_N}(1)}$
ORA1	OVR_T1	Real decimation (JMODE 9)	Channel A odd-numbered samples	$2^{\text{OVR\_N}+1(1)}$
		Complex down-conversion (JMODE 10-16, except JMODE 12)	Channel A quadrature (Q) samples	$2^{\text{OVR\_N}(1)}$
ORB0	OVR_T0	Real decimation (JMODE 9)	Channel B even-numbered samples	$2^{\text{OVR\_N}+1(1)}$
		Complex down-conversion (JMODE 10-16, except JMODE 12)	Channel B in-phase (I) samples	$2^{\text{OVR\_N}(1)}$
ORB1	OVR_T1	Real decimation (JMODE 9)	Channel B odd-numbered samples	$2^{\text{OVR\_N}+1(1)}$
		Complex down-conversion (JMODE 10-16, except JMODE 12)	Channel B quadrature (Q) samples	$2^{\text{OVR\_N}(1)}$

(1) OVR\_N is the monitoring period register setting.

Typically, the OVR\_T0 threshold can be set near the full-scale value (228 for example). When the threshold is triggered, a typical system can turn down the system gain to avoid clipping. The OVR\_T1 threshold can be set much lower. For example, the OVR\_T1 threshold can be set to 64 (peak input voltage of -12 dBFS). If the input signal is strong, the OVR\_T1 threshold is tripped occasionally. If the input is quite weak, the threshold is never tripped. The downstream logic device monitors the OVR\_T1 bit. If OVR\_T1 stays low for an extended period of time, then the system gain can be increased until the threshold is occasionally tripped (meaning the peak level of the signal is above -12 dBFS).

### 7.3.3.5 Code Error Rate (CER)

ADC cores can generate bit errors within a sample, often called *code errors (CER)* or referred to as *sparkle codes*, resulting from metastability caused by non-ideal comparator limitations. The ADC12DJ3200 uses a unique ADC architecture that inherently allows significant code error rate improvements from traditional pipelined flash or successive approximation register (SAR) ADCs. The code error rate of the ADC12DJ3200 is multiple orders of magnitude better than what can be achieved in alternative architectures at equivalent sampling rates providing significant signal reliability improvements.

### 7.3.4 Temperature Monitoring Diode

A built-in thermal monitoring diode is made available on the TDIODE+ and TDIODE- pins. This diode facilitates temperature monitoring and characterization of the device in higher ambient temperature environments. Although the on-chip diode is not highly characterized, the diode can be used effectively by performing a baseline measurement (offset) at a known ambient or board temperature and creating a linear equation with the diode voltage slope provided in the [Electrical Characteristics - DC Specifications](#) table. Perform offset measurement with the device unpowered or with the PD pin asserted to minimize device self-heating. Only assert the PD pin long enough to take the offset measurement. Recommended monitoring devices include the [LM95233](#) device and similar remote-diode temperature monitoring products from Texas Instruments.

### 7.3.5 Timestamp

The TMSTP+ and TMSTP- differential input can be used as a time-stamp input to mark a specific sample based on the timing of an external trigger event relative to the sampled signal. [TIMESTAMP\\_EN](#) (see the [LSB control bit output register](#)) must be set in order to use the timestamp feature and output the timestamp data. When enabled, the LSB of the 12-bit ADC digital output reports the status of the TMSTP± input. In effect, the 12-bit output sample consists of the upper 11-bits of the 12-bit converter and the LSB of the 12-bit output sample is the output of a parallel 1-bit converter (TMSTP±) with the same latency as the ADC core. In the 8-bit operating

modes, the LSB of the 8-bit output sample is used to output the timestamp status. The trigger must be applied to the differential TMSTP+ and TMSTP– inputs. The trigger can be asynchronous to the ADC sampling clock and is sampled at approximately the same time as the analog input. Timestamp cannot be used when a JMODE with decimation is selected and instead SYSREF must be used to achieve synchronization through the JESD204B subclass-1 method for achieving deterministic latency.

### 7.3.6 Clocking

The clocking subsystem of the ADC12DJ3200 has two input signals, device clock (CLK+, CLK–) and SYSREF (SYSREF+, SYSREF–). Within the clocking subsystem there is a noiseless aperture delay adjustment ( $t_{AD}$  adjust), a clock duty cycle corrector, and a SYSREF capture block. 图 65 describes the clocking subsystem.



图 65. ADC12DJ3200 Clocking Subsystem

The device clock is used as the sampling clock for the ADC core as well as the clocking for the digital processing and serializer outputs. Use a low-noise (low jitter) device clock to maintain high signal-to-noise ratio (SNR) within the ADC. In dual-channel mode, the analog input signal for each input is sampled on the rising edge of the device clock. In single-channel mode, both the rising and falling edges of the device clock are used to capture the analog signal to reduce the maximum clock rate required by the ADC. A noiseless aperture delay adjustment ( $t_{AD}$  adjust) allows the user to shift the sampling instance of the ADC in fine steps in order to synchronize multiple ADC12DJ3200s or to fine-tune system latency. Duty cycle correction is implemented in the ADC12DJ3200 to ease the requirements on the external device clock while maintaining high performance. 表 5 summarizes the device clock interface in dual-channel mode and single-channel mode.

表 5. Device Clock vs Mode of Operation

MODE OF OPERATION	SAMPLING RATE VS $f_{CLK}$	SAMPLING INSTANT
Dual-channel mode	$1 \times f_{CLK}$	Rising edge
Single-channel mode	$2 \times f_{CLK}$	Rising and falling edge

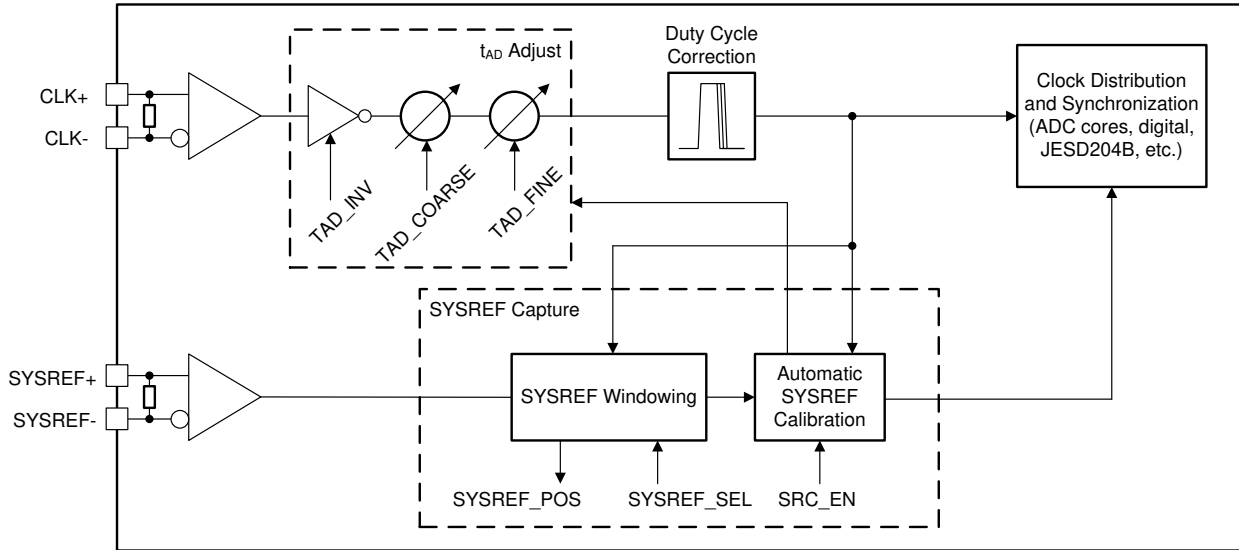
SYSREF is a system timing reference used for JESD204B subclass-1 implementations of deterministic latency. SYSREF is used to achieve deterministic latency and for multi-device synchronization. SYSREF must be captured by the correct device clock edge in order to achieve repeatable latency and synchronization. The ADC12DJ3200 includes SYSREF windowing and automatic SYSREF calibration to ease the requirements on the external clocking circuits and to simplify the synchronization process. SYSREF can be implemented as a single pulse or as a periodic clock. In periodic implementations, SYSREF must be equal to, or an integer division of, the local multiframe clock frequency. 公式 2 is used to calculate valid SYSREF frequencies.

$$f_{SYSREF} = \frac{R \times f_{CLK}}{10 \times F \times K \times n}$$

where

- R and F are set by the JMODE setting (see 表 19)
- $f_{CLK}$  is the device clock frequency ( $CLK_{\pm}$ )
- K is the programmed multiframe length (see 表 19 for valid K settings)
- and n is any positive integer

(2)

### 7.3.6.1 Noiseless Aperture Delay Adjustment ( $t_{AD}$ Adjust)

The ADC12DJ3200 contains a delay adjustment on the device clock (sampling clock) input path, called  $t_{AD}$  adjust, that can be used to shift the sampling instance within the device in order to align sampling instances among multiple devices or for external interleaving of multiple ADC12DJ3200s. Further,  $t_{AD}$  adjust can be used for automatic SYSREF calibration to simplify synchronization; see the [Automatic SYSREF Calibration](#) section. Aperture delay adjustment is implemented in a way that adds no additional noise to the clock path, however a slight degradation in aperture jitter ( $t_{AJ}$ ) is possible at large values of TAD\_COARSE because of internal clock path attenuation. The degradation in aperture jitter can result in minor SNR degradations at high input frequencies (see  $t_{AJ}$  in the [Switching Characteristics](#) table). This feature is programmed using TAD\_INV, TAD\_COARSE, and TAD\_FINE in the [DEVCLK timing adjust ramp control register](#). Setting TAD\_INV inverts the input clock resulting in a delay equal to half the clock period. 表 6 summarizes the step sizes and ranges of the TAD\_COARSE and TAD\_FINE variable analog delays. All three delay options are independent and can be used in conjunction. All clocks within the device are shifted by the programmed  $t_{AD}$  adjust amount, which results in a shift of the timing of the JESD204B serialized outputs and affects the capture of SYSREF.

表 6.  $t_{AD}$  Adjust Adjustment Ranges

ADJUSTMENT PARAMETER	ADJUSTMENT STEP	DELAY SETTINGS	MAXIMUM DELAY
TAD_INV	$1 / (f_{CLK} \times 2)$	1	$1 / (f_{CLK} \times 2)$
TAD_COARSE	See $t_{TAD(STEP)}$ in the <a href="#">Switching Characteristics</a> table	256	See $t_{TAD(MAX)}$ in the <a href="#">Switching Characteristics</a> table
TAD_FINE	See $t_{TAD(STEP)}$ in the <a href="#">Switching Characteristics</a> table	256	See $t_{TAD(MAX)}$ in the <a href="#">Switching Characteristics</a> table

In order to maintain timing alignment between converters, stable and matched power-supply voltages and device temperatures must be provided.

Aperture delay adjustment can be changed on-the-fly during normal operation but may result in brief upsets to the JESD204B data link. Use TAD\_RAMP to reduce the probability of the JESD204B link losing synchronization; see the [Aperture Delay Ramp Control \(TAD\\_RAMP\)](#) section.

### 7.3.6.2 Aperture Delay Ramp Control (TAD\_RAMP)

The ADC12DJ3200 contains a function to gradually adjust the  $t_{AD}$  adjust setting towards the newly written TAD\_COARSE value. This functionality allows the  $t_{AD}$  adjust setting to be adjusted with minimal internal clock circuitry glitches. The TAD\_RAMP\_RATE parameter allows either a slower (one TAD\_COARSE LSB per 256  $t_{CLK}$  cycles) or faster ramp (four TAD\_COARSE LSBs per 256  $t_{CLK}$  cycles) to be selected. The TAD\_RAMP\_EN parameter enables the ramp feature and any subsequent writes to TAD\_COARSE initiate a new ramp.

### 7.3.6.3 SYSREF Capture for Multi-Device Synchronization and Deterministic Latency

The clocking subsystem is largely responsible for achieving multi-device synchronization and deterministic latency. The ADC12DJ3200 uses the JESD204B subclass-1 method to achieve deterministic latency and synchronization. Subclass 1 requires that the SYSREF signal be captured by a deterministic device clock ( $CLK_{\pm}$ ) edge at each system power-on and at each device in the system. This requirement imposes setup and hold constraints on SYSREF relative to  $CLK_{\pm}$ , which can be difficult to meet at giga-sample clock rates over all system operating conditions. The ADC12DJ3200 includes a number of features to simplify this synchronization process and to relax system timing constraints:

- The ADC12DJ3200 uses dual-edge sampling (DES) in single-channel mode to reduce the  $CLK_{\pm}$  input frequency by half and double the timing window for SYSREF (see 表 5)
- A SYSREF position detector (relative to  $CLK_{\pm}$ ) and selectable SYSREF sampling position aid the user in meeting setup and hold times over all conditions; see the [SYSREF Position Detector and Sampling Position Selection \(SYSREF Windowing\)](#) section
- Easy-to-use automatic SYSREF calibration uses the aperture timing adjust block ( $t_{AD}$  adjust) to shift the ADC



sampling instance based on the phase of SYSREF (rather than adjusting SYSREF based on the phase of the ADC sampling instance); see the [Automatic SYSREF Calibration](#) section

### 7.3.6.3.1 SYSREF Position Detector and Sampling Position Selection (SYSREF Windowing)

The SYSREF windowing block is used to first detect the position of SYSREF relative to the CLK± rising edge and then to select a desired SYSREF sampling instance, which is a delay version of CLK±, to maximize setup and hold timing margins. In many cases a single SYSREF sampling position (SYSREF\_SEL) is sufficient to meet timing for all systems (device-to-device variation) and conditions (temperature and voltage variations). However, this feature can also be used by the system to expand the timing window by tracking the movement of SYSREF as operating conditions change or to remove system-to-system variation at production test by finding a unique optimal value at nominal conditions for each system.

This section describes proper usage of the SYSREF windowing block. First, apply the device clock and SYSREF to the device. The location of SYSREF relative to the device clock cycle is determined and stored in the SYSREF\_POS bits of the [SYSREF capture position register](#). ADC12DJ3200 must see at least 3 rising edges of SYSREF before the SYSREF\_POS output is valid. Each bit of SYSREF\_POS represents a potential SYSREF sampling position. If a bit in SYSREF\_POS is set to 1, then the corresponding SYSREF sampling position has a potential setup or hold violation. Upon determining the valid SYSREF sampling positions (the positions of SYSREF\_POS that are set to 0) the desired sampling position can be chosen by setting SYSREF\_SEL in the [clock control register 0](#) to the value corresponding to that SYSREF\_POS position. In general, the middle sampling position between two setup and hold instances is chosen. Ideally, SYSREF\_POS and SYSREF\_SEL are performed at the nominal operating conditions of the system (temperature and supply voltage) to provide maximum margin for operating condition variations. This process can be performed at final test and the optimal SYSREF\_SEL setting can be stored for use at every system power up. Further, SYSREF\_POS can be used to characterize the skew between CLK± and SYSREF± over operating conditions for a system by sweeping the system temperature and supply voltages. For systems that have large variations in CLK± to SYSREF± skew, this characterization can be used to track the optimal SYSREF sampling position as system operating conditions change. In general, a single value can be found that meets timing over all conditions for well-matched systems, such as those where CLK± and SYSREF± come from a single clocking device.

#### 注

SYSREF\_SEL must be set to 0 when using automatic SYSREF calibration; see the [Automatic SYSREF Calibration](#) section.

The step size between each SYSREF\_POS sampling position can be adjusted using SYSREF\_ZOOM. When SYSREF\_ZOOM is set to 0, the delay steps are coarser. When SYSREF\_ZOOM is set to 1, the delay steps are finer. See the [Switching Characteristics](#) table for delay step sizes when SYSREF\_ZOOM is enabled and disabled. In general, SYSREF\_ZOOM is recommended to always be used (SYSREF\_ZOOM = 1) unless a transition region (defined by 1's in SYSREF\_POS) is not observed, which can be the case for low clock rates. Bits 0 and 23 of SYSREF\_POS are always be set to 1 because there is insufficient information to determine if these settings are close to a timing violation, although the actual valid window can extend beyond these sampling positions. The value programmed into SYSREF\_SEL is the decimal number representing the desired bit location in SYSREF\_POS. [表 7](#) lists some example SYSREF\_POS readings and the optimal SYSREF\_SEL settings. Although 24 sampling positions are provided by the SYSREF\_POS status register, SYSREF\_SEL only allows selection of the first 16 sampling positions, corresponding to SYSREF\_POS bits 0 to 15. The additional SYSREF\_POS status bits are intended only to provide additional knowledge of the SYSREF valid window. In general, lower values of SYSREF\_SEL are selected because of delay variation over supply voltage, however in the fourth example a value of 15 provides additional margin and can be selected instead.

**表 7. Examples of SYSREF\_POS Readings and SYSREF\_SEL Selections**

SYSREF_POS[23:0]			OPTIMAL SYSREF_SEL SETTING
0x02E[7:0] (Largest Delay)	0x02D[7:0] <sup>(1)</sup>	0x02C[7:0] <sup>(1)</sup> (Smallest Delay)	
b10000000	b01100000	b00011001	8 or 9
b10011000	b00000000	b00110001	12
b10000000	b01100000	b00000001	6 or 7

(1) Red coloration indicates the bits that are selected, as given in the last column of this table.

**表 7. Examples of SYSREF\_POS Readings and SYSREF\_SEL Selections (接下页)**

SYSREF_POS[23:0]			OPTIMAL SYSREF_SEL SETTING
0x02E[7:0] (Largest Delay)	0x02D[7:0] <sup>(1)</sup>	0x02C[7:0] <sup>(1)</sup> (Smallest Delay)	
b10000000	b00000011	b00000001	4 or 15
b10001100	b01100011	b00011001	6

### 7.3.6.3.2 Automatic SYSREF Calibration

The ADC12DJ3200 has an automatic SYSREF calibration feature to alleviate the often challenging setup and hold times associated with capturing SYSREF for giga-sample data converters. Automatic SYSREF calibration uses the  $t_{AD}$  adjust feature to shift the device clock to maximize the SYSREF setup and hold times or to align the sampling instance based on the SYSREF rising edge.

The ADC12DJ3200 must have a proper device clock applied and be programmed for normal operation before starting the automatic SYSREF calibration. When ready to initiate automatic SYSREF calibration, a continuous SYSREF signal must be applied. SYSREF must be a continuous (periodic) signal when using the automatic SYSREF calibration. Start the calibration process by setting SRC\_EN high in the [SYSREF calibration enable register](#) after configuring the automatic SYSREF calibration using the SRC\_CFG register. Upon setting SRC\_EN high, the ADC12DJ3200 searches for the optimal  $t_{AD}$  adjust setting until the device clock falling edge is internally aligned to the SYSREF rising edge. TAD\_DONE in the [SYSREF calibration status register](#) can be monitored to ensure that the SYSREF calibration has finished. By aligning the device clock falling edge with the SYSREF rising edge, automatic SYSREF calibration maximizes the internal SYSREF setup and hold times relative to the device clock and also sets the sampling instant based on the SYSREF rising edge. After the automatic SYSREF calibration finishes, the rest of the startup procedure can be performed to finish bringing up the system.

For multi-device synchronization, the SYSREF rising edge timing must be matched at all devices and therefore trace lengths must be matched from a common SYSREF source to each ADC12DJ3200. Any skew between the SYSREF rising edge at each device results in additional error in the sampling instance between devices, however repeatable deterministic latency from system startup to startup through each device must still be achieved. No other design requirements are needed in order to achieve multi-device synchronization as long as a proper elastic buffer release point is chosen in the JESD2048 receiver.

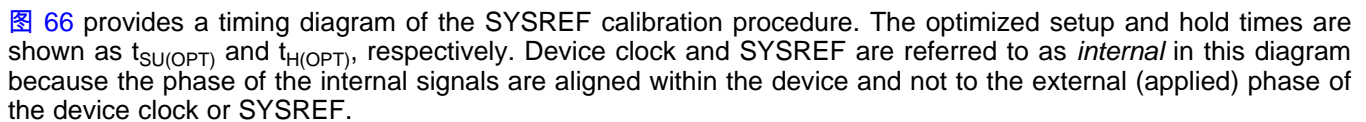
 **图 66** provides a timing diagram of the SYSREF calibration procedure. The optimized setup and hold times are shown as  $t_{SU(OPT)}$  and  $t_{H(OPT)}$ , respectively. Device clock and SYSREF are referred to as *internal* in this diagram because the phase of the internal signals are aligned within the device and not to the external (applied) phase of the device clock or SYSREF.





图 66. SYSREF Calibration Timing Diagram

When finished, the  $t_{AD}$  adjust setting found by the automatic SYSREF calibration can be read from SRC\_TAD in the [SYSREF calibration status register](#). After calibration, the system continues to use the calibrated  $t_{AD}$  adjust setting for operation until the system is powered down. However, if desired, the user can then disable the SYSREF calibration and fine-tune the  $t_{AD}$  adjust setting according to the systems needs. Alternatively, the use of the automatic SYSREF calibration can be done at product test (or periodic recalibration) of the optimal  $t_{AD}$  adjust setting for each system. This value can be stored and written to the TAD register (TAD\_INV, TAD\_COARSE, and TAD\_FINE) upon system startup.

Do not run the SYSREF calibration when the ADC calibration (foreground or background) is running. If background calibration is the desired use case, disable the background calibration when the SYSREF calibration is used, then reenale the background calibration after TAD\_DONE goes high. SYSREF\_SEL in the [clock control register 0](#) must be set to 0 when using SYSREF calibration.

SYSREF calibration searches the TAD\_COARSE delays using both noninverted (TAD\_INV = 0) and inverted clock polarity (TAD\_INV = 1) to minimize the required TAD\_COARSE setting in order to minimize loss on the clock path to reduce aperture jitter ( $t_{AJ}$ ).

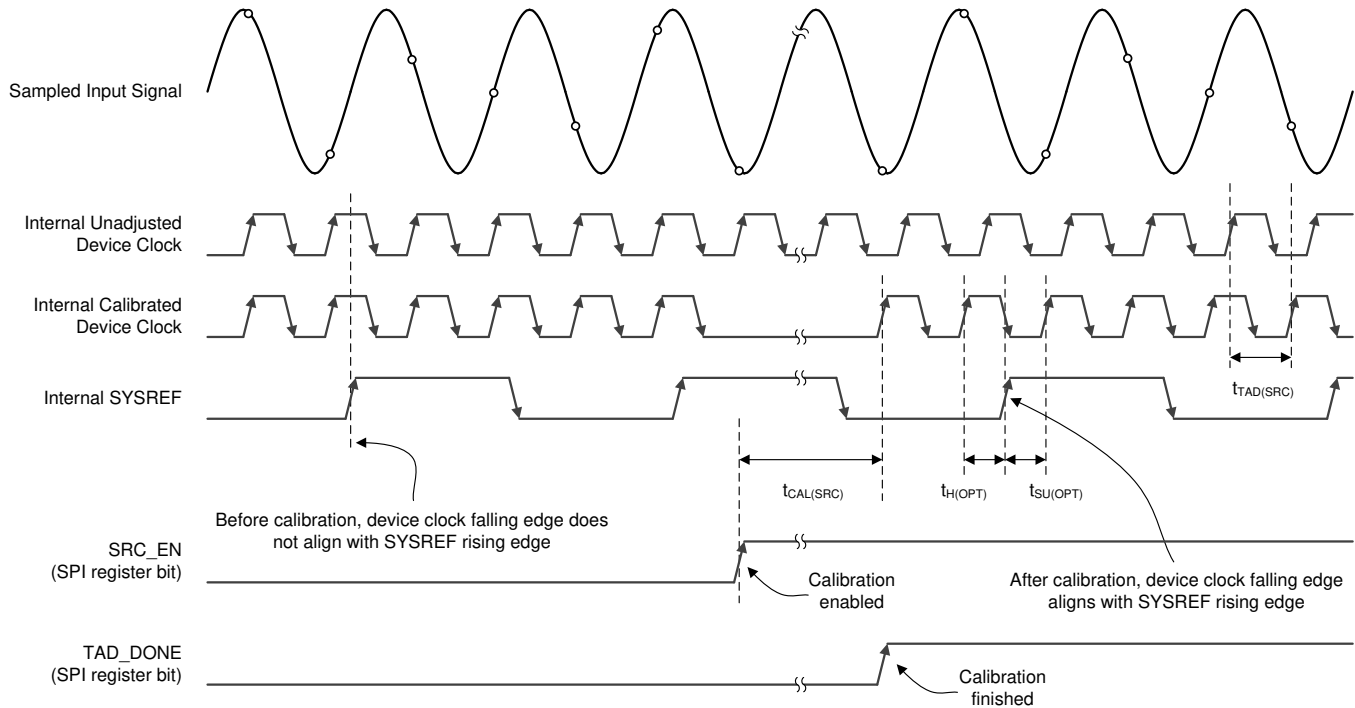
### 7.3.7 Digital Down Converters (Dual-Channel Mode Only)

After converting the analog voltage to a digital value, the digitized sample can either be sent directly to the JESD204B interface block (DDC bypass) or sent to the digital down conversion (DDC) block for frequency conversion and decimation (in dual-channel mode only). Frequency conversion and decimation allow a specific frequency band to be selected and output in the digital data stream while reducing the effective data rate and interface speed or width. The DDC is designed such that the digital processing does not degrade the noise spectral density (NSD) performance of the ADC. 图 67 illustrates the digital down converter for channel A of the ADC12DJ3200. Channel B has the same structure with the input data selected by DIG\_BIND\_B and the NCO selection mux controlled by pins NCOB[1:0] or through CSELB[1:0].



图 67. Channel A Digital Down Conversion Block (Dual-Channel Mode Only)

### 7.3.7.1 Numerically-Controlled Oscillator and Complex Mixer

The DDC contains a complex numerically-controlled oscillator (NCO) and a complex mixer. 公式 3 shows the complex exponential sequence generated by the oscillator.

$$x[n] = e^{j\omega n} \tag{3}$$

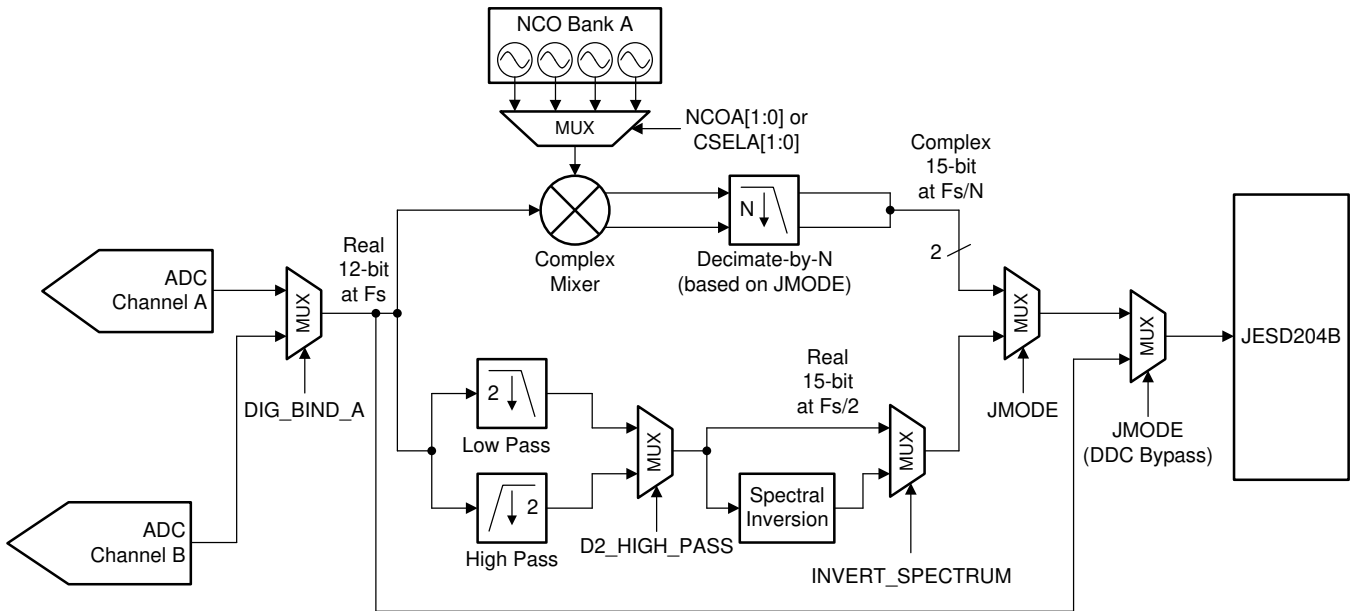
The frequency ( $\omega$ ) is specified by a 32-bit register setting. The complex exponential sequence is multiplied by the real input from the ADC to mix the desired carrier to a frequency equal to  $f_{IN} + f_{NCO}$ , where  $f_{IN}$  is the analog input frequency after aliasing (in undersampling systems) and  $f_{NCO}$  is the programmed NCO frequency.

#### 7.3.7.1.1 NCO Fast Frequency Hopping (FFH)

Fast frequency hopping (FFH) is made possible by each DDC having four independent NCOs that can be controlled by the NCOA0 and NCOA1 pins for DDC A and the NCOB0 and NCOB1 pins for DDC B. Each NCO has independent frequency settings (see the [Basic NCO Frequency Setting Mode](#) section) and initial phase settings (see the [NCO Phase Offset Setting](#) section) that can be set independently. Further, all NCOs have independent phase accumulators that continue to run when the specific NCO is not selected, allowing the NCOs to maintain their phase between selection so that downstream processing does not need to perform carrier recovery after each hop, for instance.

NCO hopping occurs when the NCO GPIO pins change state. The pins are controlled asynchronously and therefore synchronous switching is not possible. Associated latencies are demonstrated in 图 68, where  $t_{TX}$  and  $t_{ADC}$  are provided in the *Switching Characteristics* table. All latencies in 表 8 are approximations only.



图 68. NCO Fast Frequency Hopping Latency Diagram

表 8. NCO Fast Frequency Hopping Latency Definitions

LATENCY PARAMETER	VALUE OR CALCULATION	UNITS
$t_{GPIO-MIXER}$	~36 to ~40	$t_{CLK}$ cycles
$t_{ADC-MIXER}$	~36	$t_{CLK}$ cycles
$t_{MIXER-TX}$	$(t_{TX} + t_{ADC}) - t_{ADC-MIXER}$	$t_{CLK}$ cycles

### 7.3.7.1.2 NCO Selection

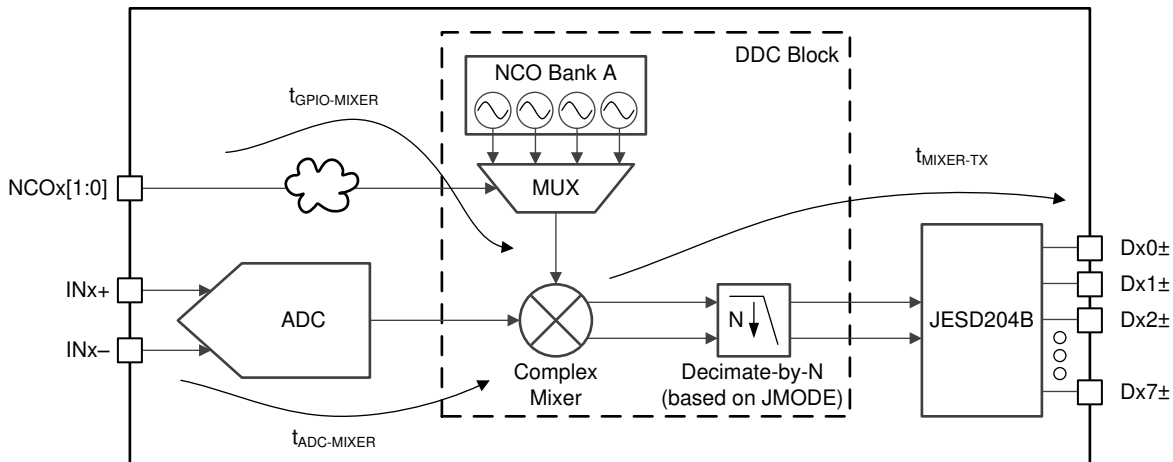
Within each channel DDC, four different frequency and phase settings are available for use. Each of the four settings use a different phase accumulator within the NCO. Because all four phase accumulators are independent and continuously running, rapid switching between different NCO frequencies is possible allowing for phase coherent frequency hopping.

The specific frequency-phase pair used for each channel is selected through the NCOA[1:0] or NCOB[1:0] input pins when CMODE is set to 1. Alternatively, the selected NCO can be chosen through SPI by CSELA for DDC A and CSELB for DDC B by setting CMODE to 0 (default). The logic table for NCO selection is provided in 表 9 for both the GPIO and SPI selection options.

表 9. Logic Table for NCO Selection Using GPIO or SPI

NCO SELECTION	CMODE	NCOx1	NCOx0	CSELx[1]	CSELx[0]
NCO 0 using GPIO	1	0	0	X	X
NCO 1 using GPIO	1	0	1	X	X
NCO 2 using GPIO	1	1	0	X	X
NCO 3 using GPIO	1	1	1	X	X
NCO 0 using SPI	0	X	X	0	0
NCO 1 using SPI	0	X	X	0	1
NCO 2 using SPI	0	X	X	1	0
NCO 3 using SPI	0	X	X	1	1

The frequency for each phase accumulator is programmed independently through the  $FREQAx$ ,  $FREQBx$  ( $x = 0$  to 3) and, optionally,  $NCO\_RDIV$  register settings. The phase offset for each accumulator is programmed independently through the  $PHASEAx$  and  $PHASEBx$  ( $x = 0$  to 3) register settings.

### 7.3.7.1.3 Basic NCO Frequency Setting Mode

In basic NCO frequency-setting mode ( $NCO\_RDIV = 0x0000$ ), the NCO frequency setting is set by the 32-bit register value,  $FREQAx$  and  $FREQBx$  ( $x = 0$  to 3). The NCO frequency for DDC A can be calculated using [公式 4](#), where  $FREQAx$  can be replaced by  $FREQBx$  to calculate the NCO frequency for DDC B.

$$f_{(NCO)} = FREQAx \times 2^{-32} \times f_{(DEVCLK)} \quad (x = 0 - 3) \quad (4)$$

#### 注

Changing the  $FREQAx$  and  $FREQBx$  register settings during operation results in a non-deterministic NCO phase. If deterministic phase is required, the NCOs must be resynchronized; see the [NCO Phase Synchronization](#) section.

### 7.3.7.1.4 Rational NCO Frequency Setting Mode

In basic NCO frequency mode, the frequency step size is very small and many frequencies can be synthesized, but sometimes an application requires very specific frequencies that fall between two frequency steps. For example with  $f_S$  equal to 2457.6 MHz and a desired  $f_{(NCO)}$  equal to 5.02 MHz, the value for  $FREQAx$  is 8773085.867. Truncating the fractional portion results in an  $f_{(NCO)}$  equal to 5.0199995 MHz, which is not the desired frequency.

To produce the desired frequency, the  $NCO\_RDIV$  parameter is used to force the phase accumulator to arrive at specific frequencies without error. First, select a frequency step size ( $f_{(STEP)}$ ) that is appropriate for the NCO frequency steps required. The typical value of  $f_{(STEP)}$  is 10 kHz. Next, use [公式 5](#) to program the  $NCO\_RDIV$  value.

$$NCO\_RDIV = \frac{(f_{DEVCLK} / f_{STEP})}{64} \quad (5)$$

The result of [公式 5](#) must be an integer value. If the value is not an integer, adjust either of the parameters until the result is an integer value.

For example, select a value of 1920 for  $NCO\_RDIV$ .

#### 注

$NCO\_RDIV$  values larger than 8192 can degrade the NCO SFDR performance and are not recommended.

Now use [公式 6](#) to calculate the  $FREQAx$  register value.

$$FREQAx = \text{round}\left(2^{32} \times f_{NCO} / f_{DEVCLK}\right) \quad (6)$$

Alternatively, the following equations can be used:

$$N = \frac{f_{(NCO)}}{f_{(STEP)}} \quad (7)$$

$$FREQAx = \text{round}\left(2^{26} \times N / NCO\_RDIV\right) \quad (8)$$

表 10 lists common values for NCO\_RDIV in 10-kHz frequency steps.

**表 10. Common NCO\_RDIV Values (For 10-kHz Frequency Steps)**

$f_{CLK}$ (MHz)	NCO_RDIV
2457.6	3840
1966.08	3072
1600	2500
1474.56	2304
1228.8	1920

#### 7.3.7.1.5 NCO Phase Offset Setting

The NCO phase-offset setting for each NCO is set by the 16-bit register value PHASEAx and PHASEBx (where  $x = 0$  to 3). The value is left-justified into a 32-bit field and then added to the phase accumulator.

Use 公式 9 to calculate the phase offset in radians.

$$\Phi(\text{rad}) = \text{PHASEA}/Bx \times 2^{-16} \times 2 \times \pi \quad (x = 0 \text{ to } 3) \quad (9)$$

#### 7.3.7.1.6 NCO Phase Synchronization

The NCOs must be synchronized after setting or changing the value of FREQAx or FREQBx. NCO synchronization is performed when the JESD204B link is initialized or by SYSREF, based on the settings of NCO\_SYNC\_ILA and NCO\_SYNC\_NEXT. The procedures are as follows for the JESD204B initialization procedure and the SYSREF procedure for both DC-coupled and AC-coupled SYSREF signals.

NCO synchronization using the JESD204B SYNC signal ( $\overline{\text{SYNCSE}}$  or  $\text{TMSTP}\pm$ ):

1. The device must be programmed for normal operation
2. Set NCO\_SYNC\_ILA to 1 to enable NCO synchronization using the SYNC signal
3. Set JESD\_EN to 0
4. Program FREQAx, FREQBx, PHASEAx, and PHASEBx to the desired settings
5. In the JESD204B receiver (logic device), deassert the  $\overline{\text{SYNC}}$  signal by setting  $\overline{\text{SYNC}}$  high
6. Set JESD\_EN to 1
7. Assert the  $\overline{\text{SYNC}}$  signal by setting  $\overline{\text{SYNC}}$  low in the JESD204B receiver to start the code group synchronization (CGS) process
8. After achieving CGS, deassert the  $\overline{\text{SYNC}}$  signal by setting  $\overline{\text{SYNC}}$  high at the same time for all ADCs to be synchronized and verify that the SYNC setup and hold times are met (as specified in the [Timing Requirements](#) table)

NCO synchronization using SYSREF (DC-coupled):

1. The device must be programmed for normal operation
2. Set JESD\_EN to 1 to start the JESD204B link (the SYNC signal can respond as normal during the CGS process)
3. Program NCO\_SYNC\_ILA=0 on all devices.
4. Issue one or more SYSREF pulses to all ADCs to synchronize the local multiframe clock. Verify that SYSREF is disabled (held low) before continuing.
5. Program FREQAx, FREQBx, PHASEAx, and PHASEBx to the desired settings
6. Write NCO\_SYNC\_NEXT to 0.
7. Arm NCO synchronization by setting NCO\_SYNC\_NEXT to 1
8. Issue a single SYSREF pulse to all ADCs to synchronize NCOs within all devices. The SYSREF pulse must have the same phase relationship to the LMFC as the SYSREF pulse(s) from step 4 above.

NCO synchronization using SYSREF (AC-coupled):

1. The device must be programmed for normal operation
2. Set JESD\_EN to 1 to start the JESD204B link (the SYNC signal can respond as normal during the CGS process)
3. Program NCO\_SYNC\_ILA=0 on all devices.
4. Enable the SYSREF generator for all ADCs to synchronize the local multiframe clock. Leave SYSREF running continuously.
5. Program FREQAx, FREQBx, PHASEAx, and PHASEBx to the desired settings
6. Write NCO\_SYNC\_NEXT to 0.
7. Arm NCO synchronization by setting NCO\_SYNC\_NEXT to 1 at the same time at all ADCs by timing the rising edge of SCLK for the last data bit (LSB) at the end of the SPI write so that the SCLK rising edge occurs after a SYSREF rising edge and early enough before the next SYSREF rising edge so that the trigger is armed before the next SYSREF rising edge (a long SYSREF period is recommended)
8. NCOs in all ADCs are synchronized by the next SYSREF rising edge

### 7.3.7.2 Decimation Filters

The decimation filters are arranged to provide a programmable overall decimation of 2, 4, 8, or 16. All filter outputs have a resolution of 15 bits. The decimate-by-2 filter has a real output and the decimate-by-4, decimate-by-8, and decimate-by-16 filters have complex outputs. 表 11 lists the effective output sample rates, available signal bandwidths, output formats, and stop-band attenuation for each decimation mode. The available bandwidths of the complex output modes are twice that of equivalent real decimation modes because of the nature of the I/Q data and complex signaling. This higher bandwidth results in the decimate-by-2 real and decimate-by-4 complex modes having approximately the same useful output bandwidth.

**表 11. Output Sample Rates and Signal Bandwidths**

DECIMATION SETTING	$f_{(DEVCLK)}$				OUTPUT FORMAT
	OUTPUT RATE (MSPS)	MAX ALIAS PROTECTED SIGNAL BANDWIDTH (MHz)	STOP-BAND ATTENUATION	PASS-BAND RIPPLE	
No decimation	$f_{(DEVCLK)}$	$f_{(DEVCLK)} / 2$	—	< ±0.001 dB	Real signal, 12-bit data
Decimate-by-2	$f_{(DEVCLK)} / 2$	$0.4 \times f_{(DEVCLK)} / 2$	> 89 dB	< ±0.001 dB	Real signal, 15-bit data
Decimate-by-4 (D4_AP87 = 0)	$f_{(DEVCLK)} / 4$	$0.8 \times f_{(DEVCLK)} / 4$	> 90 dB	< ±0.001 dB	Complex signal, 15-bit data
Decimate-by-4 (D4_AP87 = 1)	$f_{(DEVCLK)} / 4$	$0.875 \times f_{(DEVCLK)} / 4$	> 66 dB	< ±0.005 dB	Complex signal, 15-bit data
Decimate-by-8	$f_{(DEVCLK)} / 8$	$0.8 \times f_{(DEVCLK)} / 8$	> 90 dB	< ±0.001 dB	Complex signal, 15-bit data
Decimate-by-16	$f_{(DEVCLK)} / 16$	$0.8 \times f_{(DEVCLK)} / 16$	> 90 dB	< ±0.001 dB	Complex signal, 15-bit data

图 69 到 图 80 provide the composite decimation filter responses. The pass-band section (black trace) shows the alias-protected region of the response. The transition band (red trace) shows the transition region of the response, or the regions that alias into the transition region, which is not alias protected and therefore desired signals must not be within this band. The aliasing band (blue trace) shows the attenuation applied to the bands that alias back into the pass band after decimation and are sufficiently low to prevent undesired signals from showing up in the pass band. Use analog input filtering for additional attenuation of the aliasing band or to prevent harmonics, interleaving spurs, or other undesired spurious signals from folding into the desired signal band before the decimation filter.



图 69. Decimate-by-2 Composite Response (D2\_HIGH\_PASS = 0)



图 70. Decimate-by-2 Composite Zoomed Pass-Band Response (D2\_HIGH\_PASS = 0)

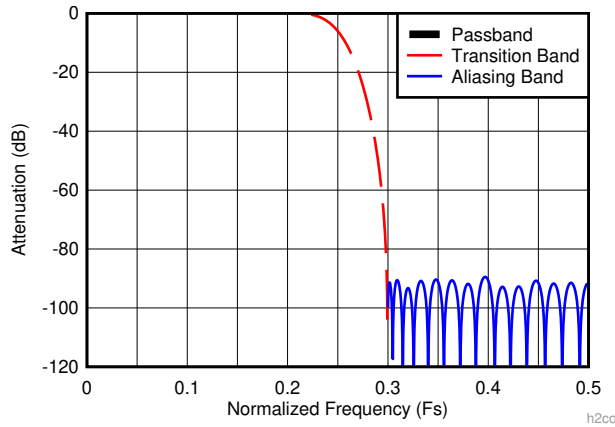

图 71. Decimate-by-2 Composite Response (D2\_HIGH\_PASS = 1)

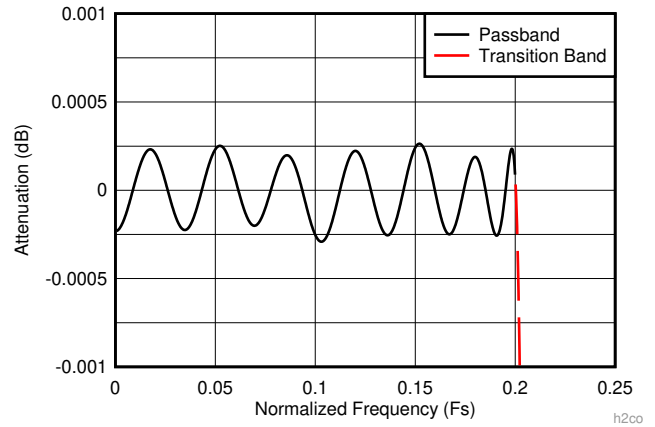

图 72. Decimate-by-2 Composite Zoomed Pass-Band Response (D2\_HIGH\_PASS = 1)

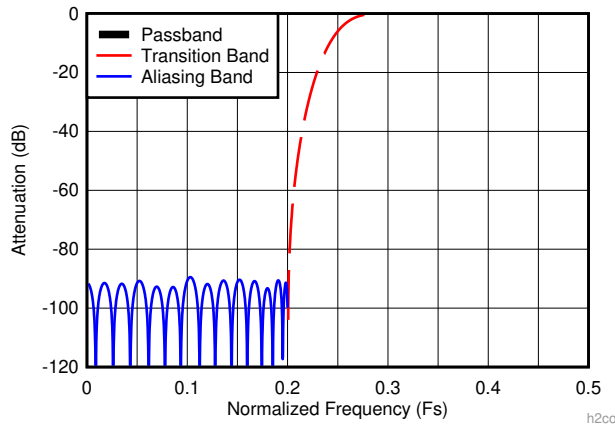

图 73. Decimate-by-4 Composite Response (D4\_AP87 = 0)

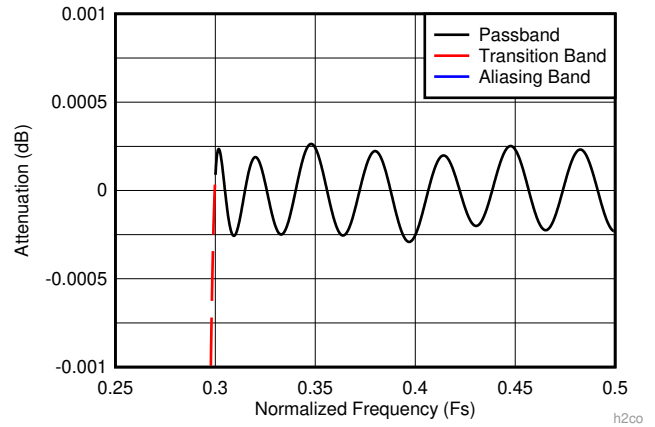

图 74. Decimate-by-4 Composite Zoomed Pass-Band Response (D4\_AP87 = 0)



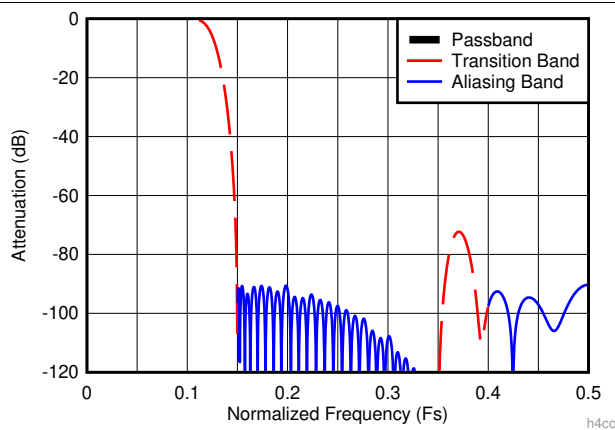

图 75. Decimate-by-4 Composite Response (D4\_AP87 = 1)

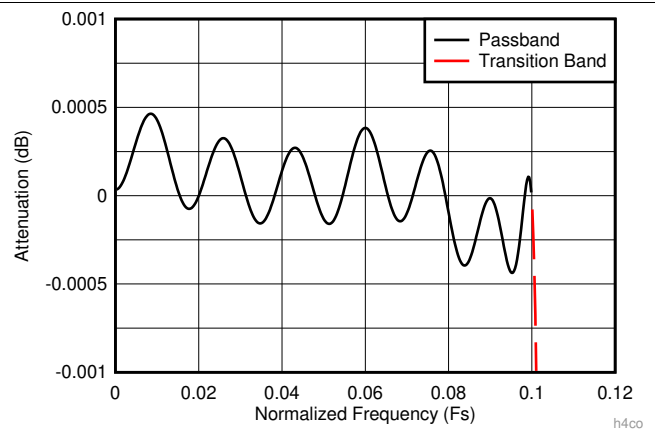

图 76. Decimate-by-4 Composite Zoomed Pass-Band Response (D4\_AP87 = 1)

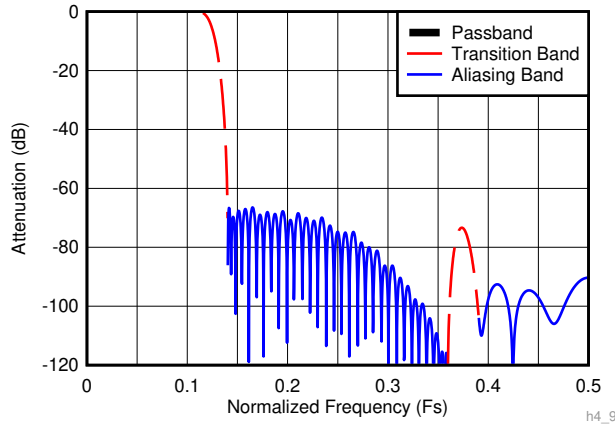

图 77. Decimate-by-8 Composite Response

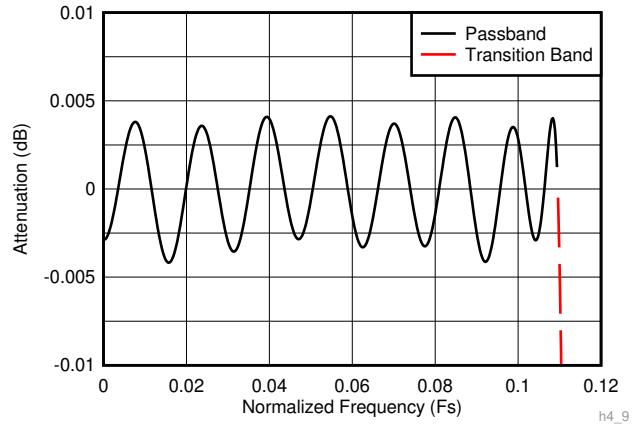

图 78. Decimate-by-8 Composite Zoomed Pass-Band Response

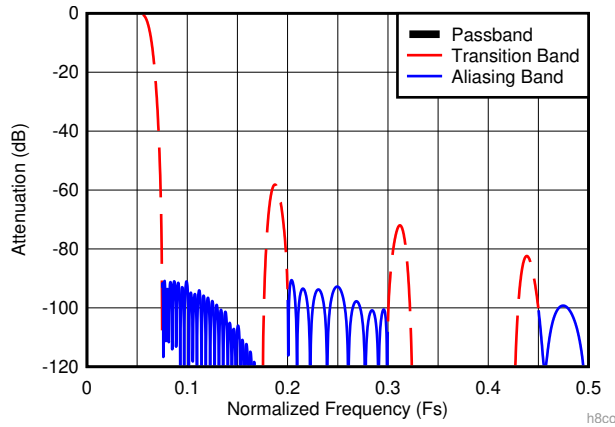

图 79. Decimate-by-16 Composite Response

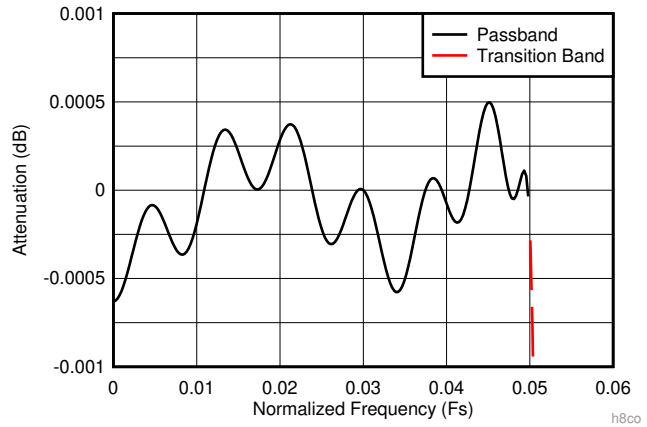

图 80. Decimate-by-16 Composite Zoomed Pass-Band Response

For maximum efficiency, a group of high-speed filter blocks are implemented with specific blocks used for each decimation setting to achieve the composite responses illustrated in 图 69 to 图 80. 表 12 describes the combination of filter blocks used for each decimation setting and 表 13 lists the coefficient details and decimation factor of each filter block. The coefficients are symmetric with the center tap indicated by bold text.

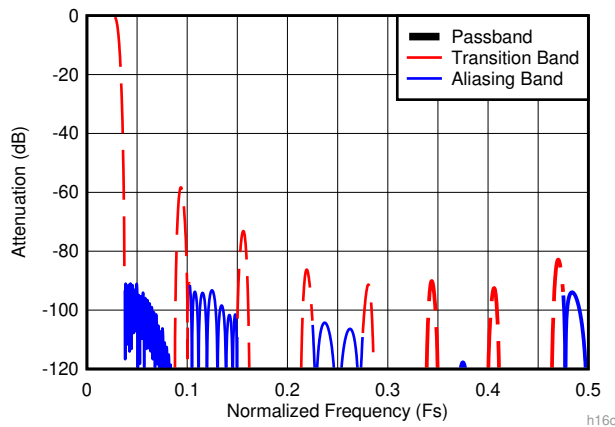
**表 12. Decimation Mode Filter Usage**

DECIMATION SETTING	FILTER BLOCKS USED
2	CS80
4 (D4_AP87 = 0)	CS45, CS80
4 (D4_AP87 = 1)	CS45, CS87
8	CS20, CS40, CS80
16	CS10, CS20, CS40, CS80

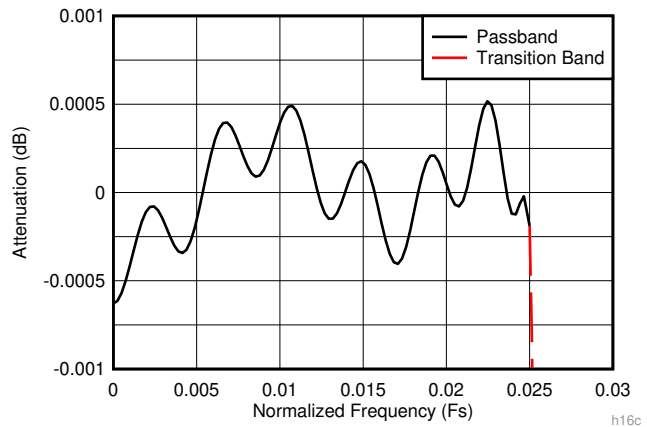
**表 13. Filter Coefficient Details**

FILTER COEFFICIENT SET (Decimation Factor of Filter)											
CS10 (2)		CS20 (2)		CS40 (2)		CS45 (2)		CS80 (2)		CS87 (2)	
-65	-65	109	109	-327	-327	56	56	-37	-37	-15	-15
0	0	0	0	0	0	0	0	0	0	0	0
577	577	-837	-837	2231	2231	-401	-401	118	118	23	23
<b>1024</b>		0	0	0	0	0	0	0	0	0	0
		4824	4824	-8881	-8881	1596	1596	-291	-291	-40	-40
		<b>8192</b>		0	0	0	0	0	0	0	0
				39742	39742	-4979	-4979	612	612	64	64
				<b>65536</b>		0	0	0	0	0	0
						20113	20113	-1159	-1159	-97	-97
						<b>32768</b>		0	0	0	0
								2031	2031	142	142
								0	0	0	0
								-3356	-3356	-201	-201
								0	0	0	0
								5308	5308	279	279
								0	0	0	0
								-8140	-8140	-380	-380
								0	0	0	0
								12284	12284	513	513
								0	0	0	0
								-18628	-18628	-690	-690
								0	0	0	0
								29455	29455	939	939
								0	0	0	0
								-53191	-53191	-1313	-1313
								0	0	0	0
								166059	166059	1956	1956
								<b>262144</b>		0	0
										-3398	-3398
										0	0
										10404	10404
										<b>16384</b>	

### 7.3.7.3 Output Data Format

The DDC output data varies depending on the selected JMODE. Real decimate-by-2 mode (JMODE 9) consists of 15-bit real output data. Complex decimation modes (JMODE 10 to 16), except for JMODE 12, consist of 15-bit complex data plus the two overrange threshold-detection control bits. JMODE 12 output data consists of 12-bit complex data, but does not include the two overrange threshold-detection control bits that must instead be monitored using the ORA0, ORA1 and ORB0, ORB1 output pins. 表 14 lists the data format for JMODE 9 and 表 15 lists the data format for all JMODEs except JMODE 12.

**表 14. Real Decimation (JMODE 9) Output Sample Format**

DDC CHANNEL	ODD, EVEN SAMPLE	16-BIT OUTPUT WORD															
		15	14	13	12	11	10	9	8	7	6	5	4	3	2	1	0
A	Even	DDC A even-numbered sample, 15-bit output data															OVR_T0
A	Odd	DDC A odd-numbered sample, 15-bit output data															OVR_T1
B	Even	DDC B even-numbered sample, 15-bit output data															OVR_T0
B	Odd	DDC B odd-numbered sample, 15-bit output data															OVR_T1

**表 15. Complex Decimation Output Sample Format (Except JMODE 12)**

I/Q SAMPLE	16-BIT OUTPUT WORD															
	15	14	13	12	11	10	9	8	7	6	5	4	3	2	1	0
I	DDC in-phase (I) 15-bit output data															OVR_T0
Q	DDC quadrature (Q) 15-bit output data															OVR_T1

### 7.3.7.4 Decimation Settings

#### 7.3.7.4.1 Decimation Factor

The decimation setting is adjustable over the following settings and is set by the JMODE parameter. See [表 19](#) for the available JMODE values and the corresponding decimation settings.

- DDC Bypass: No decimation, real output
- Decimate-by-2: Real output (JMODE 9)
- Decimate-by-4: Complex output (JMODE 10 to 12)
- Decimate-by-8: Complex output (JMODE 13 to 14)
- Decimate-by-16: Complex output (JMODE 15 to 16)

#### 7.3.7.4.2 DDC Gain Boost

The DDC gain boost (see the [DDC configuration register](#)) provides additional gain through the DDC block. Setting BOOST to 1 sets the total decimation filter chain gain to 6.02 dB. With a setting of 0, the total decimation filter chain has a 0-dB gain. Only use this setting when the negative image of the input signal is filtered out by the decimation filters, otherwise clipping may occur. There is no reduction in analog performance when gain boost is enabled or disabled, but care must be taken to understand the reference output power for proper performance calculations.

### 7.3.8 JESD204B Interface

The ADC12DJ3200 uses the JESD204B high-speed serial interface for data converters to transfer data from the ADC to the receiving logic device. The ADC12DJ3200 serialized lanes are capable of operating up to 12.8 Gbps, slightly above the JESD204B maximum lane rate. A maximum of 16 lanes can be used to allow lower lane rates for interfacing with speed-limited logic devices. 图 81 shows a simplified block diagram of the JESD204B interface protocol.



图 81. Simplified JESD204B Interface Diagram

The various signals used in the JESD204B interface and the associated ADC12DJ3200 pin names are summarized briefly in 表 16 for reference.

表 16. Summary of JESD204B Signals

SIGNAL NAME	ADC12DJ3200 PIN NAMES	DESCRIPTION
Data	DA[7:0]+, DA[7:0]-, DB[7:0]+, DB[7:0]-)	High-speed serialized data after 8b, 10b encoding
$\overline{\text{SYNC}}$	$\overline{\text{SYNCSE}}$ , TMSTP+, TMSTP-	Link initialization signal, toggles low to start code group synchronization (CGS) process
Device clock	CLK+, CLK-	ADC sampling clock, also used for clocking digital logic and output serializers
SYSREF	SYSREF+, SYSREF-	System timing reference used to deterministically reset the internal local multiframe counters in each JESD204B device

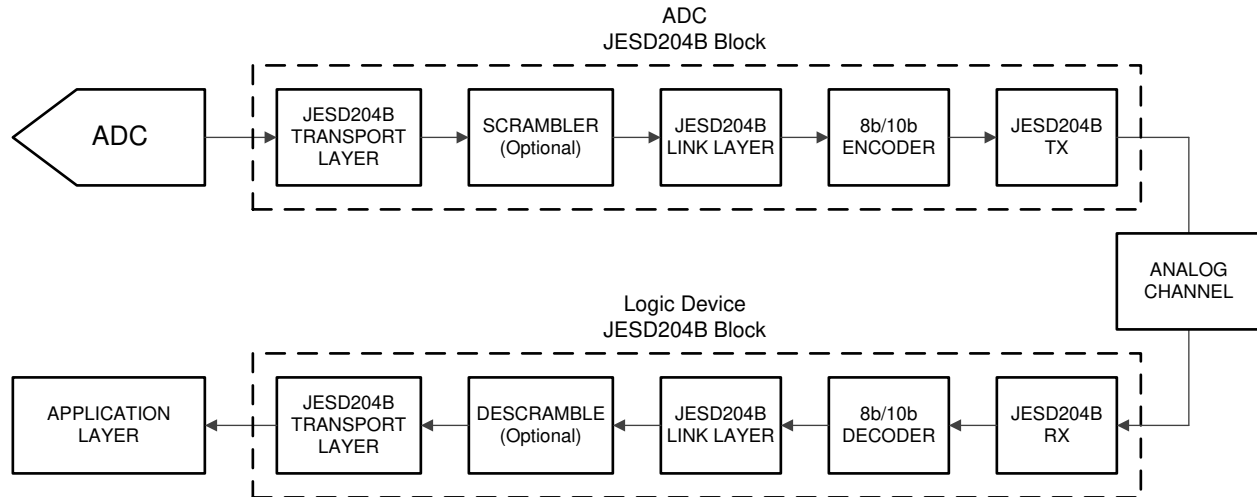
#### 7.3.8.1 Transport Layer

The transport layer takes samples from the ADC output (in decimation bypass mode) or from the DDC output and maps the samples into octets, frames, multiframe, and lanes. Sample mapping is defined by the JESD204B mode that is used, defined by parameters such as L, M, F, S, N, N', CF, and so forth. There are a number of predefined transport layer modes in the ADC12DJ3200 that are defined in 表 19. The high level configuration parameters for the transport layer in the ADC12DJ3200 are described in 表 17. For simplicity, the transport layer mode is chosen by simply setting the JMODE parameter and the desired K value. For reference, the various configuration parameters for JESD204B are defined in 表 18.

### 7.3.8.2 Scrambler

An optional data scrambler can be used to scramble the octets before transmission across the channel. Scrambling is recommended in order to remove the possibility of spectral peaks in the transmitted data. The JESD204B receiver automatically synchronizes its descrambler to the incoming scrambled data stream. The initial lane alignment sequence (ILA) is never scrambled. Scrambling can be enabled by setting SCR (in the [JESD204B control register](#)).

### 7.3.8.3 Link Layer

The link layer serves multiple purposes in JESD204B, including establishing the code boundaries (see the [Code Group Synchronization \(CGS\)](#) section), initializing the link (see the [Initial Lane Alignment Sequence \(ILAS\)](#) section), encoding the data (see the [8b, 10b Encoding](#) section), and monitoring the health of the link (see the [Frame and Multiframe Monitoring](#) section).

#### 7.3.8.3.1 Code Group Synchronization (CGS)

The first step in initializing the JESD204B link, after SYSREF is processed, is to achieve code group synchronization. The receiver first asserts the SYNC signal when ready to initialize the link. The transmitter responds to the request by sending a stream of K28.5 characters. The receiver then aligns its character clock to the K28.5 character sequence. Code group synchronization is achieved after receiving four K28.5 characters successfully. The receiver deasserts SYNC on the next local multiframe clock (LMFC) edge after CGS is achieved and waits for the transmitter to start the initial lane alignment sequence.

#### 7.3.8.3.2 Initial Lane Alignment Sequence (ILAS)

After the transmitter detects the SYNC signal deassert, the transmitter waits until its next LMFC edge to start sending the initial lane alignment sequence. The ILAS consists of four multiframe each containing a predetermined sequence. The receiver searches for the start of the ILAS to determine the frame and multiframe boundaries. As the ILAS reaches the receiver for each lane, the lane starts to buffer its data until all receivers have received the ILAS and subsequently release the ILAS from all lanes at the same time in order to align the lanes. The second multiframe of the ILAS contains configuration parameters for the JESD204B that can be used by the receiver to verify that the transmitter and receiver configurations match.

#### 7.3.8.3.3 8b, 10b Encoding

The data link layer converts the 8-bit octets from the transport layer into 10-bit characters for transmission across the link using 8b, 10b encoding. 8b, 10b encoding provides DC balance for AC-coupling of the SerDes links and a sufficient number of edge transitions for the receiver to reliably recover the data clock. 8b, 10b also provides some amount of error detection where a single bit error in a character likely results in either not being able to find the 10-bit character in the 8b, 10b decoder lookup table or incorrect character disparity.

#### 7.3.8.3.4 Frame and Multiframe Monitoring

The ADC12DJ3200 supports frame and multiframe monitoring for verifying the health of the JESD204B link. If the last octet of a frame matches the last octet of the previous frame, then the last octet in the second frame is replaced with an /F/ (/K28.7/) character. If the second frame is the last frame of a multiframe, then an /A/ (/K28.3/) character is used instead. When scrambling is enabled, if the last octet of a frame is 0xFC then the transmitter replaces the octet with an /F/ (/K28.7/) character. With scrambling, if the last octet of a multiframe is 0x7C then the transmitter replaces the octet with an /A/ (/K28.3/) character. When the receiver detects an /F/ or /A/ character, the receiver checks if the character occurs at the end of a frame or multiframe, and replaces that octet with the appropriate data character. The receiver can report an error if the alignment characters occur in the incorrect place and trigger a link realignment.

### 7.3.8.4 Physical Layer

The JESD204B physical layer consists of a current mode logic (CML) output driver and receiver. The receiver consists of a clock detection and recovery (CDR) unit to extract the data clock from the serialized data stream and can contain an equalizer to correct for the low-pass response of the physical transmission channel. Likewise, the transmitter can contain pre-equalization to account for frequency dependent losses across the channel. The total reach of the SerDes links depends on the data rate, board material, connectors, equalization, noise and jitter, and required bit-error performance. The SerDes lanes do not have to be matched in length because the receiver aligns the lanes during the initial lane alignment sequence.

#### 7.3.8.4.1 SerDes Pre-Emphasis

The ADC12DJ3200 high-speed output drivers can pre-equalize the transmitted data stream by using pre-emphasis in order to compensate for the low-pass response of the transmission channel. Configurable pre-emphasis settings allow the output drive waveform to be optimized for different PCB materials and signal transmission distances. The pre-emphasis setting is adjusted through the serializer pre-emphasis setting SER\_PE (in the [serializer pre-emphasis control register](#)). Higher values increase the pre-emphasis to compensate for more lossy PCB materials. This adjustment is best used in conjunction with an eye-diagram analysis capability in the receiver. Adjust the pre-emphasis setting to optimize the eye-opening for the specific hardware configuration and line rates needed.

#### 7.3.8.5 JESD204B Enable

The JESD204B interface must be disabled through JESD\_EN (in the [JESD204B enable register](#)) while any of the other JESD204B parameters are being changed. When JESD\_EN is set to 0 the block is held in reset and the serializers are powered down. The clocks for this section are also gated off to further save power. When the parameters are set as desired, the JESD204B block can be enabled (JESD\_EN is set to 1).

#### 7.3.8.6 Multi-Device Synchronization and Deterministic Latency

JESD204B subclass 1 outlines a method to achieve deterministic latency across the serial link. If two devices achieve the same deterministic latency then they can be considered synchronized. This latency must be achieved from system startup to startup to be deterministic. There are two key requirements to achieve deterministic latency. The first is proper capture of SYSREF for which the ADC12DJ3200 provides a number of features to simplify this requirement at giga-sample clock rates (see the [SYSREF Capture for Multi-Device Synchronization and Deterministic Latency](#) section for more information).

The second requirement is to choose a proper elastic buffer release point in the receiver. Because the ADC12DJ3200 is an ADC, the ADC12DJ3200 is the transmitter (TX) in the JESD204B link and the logic device is the receiver (RX). The elastic buffer is the key block for achieving deterministic latency, and does so by absorbing variations in the propagation delays of the serialized data as the data travels from the transmitter to the receiver. A proper release point is one that provides sufficient margin against delay variations. An incorrect release point results in a latency variation of one LMFC period. Choosing a proper release point requires knowing the average arrival time of data at the elastic buffer, referenced to an LMFC edge, and the total expected delay variation for all devices. With this information the region of invalid release points within the LMFC period can be defined, which stretches from the minimum to maximum delay for all lanes. Essentially, the designer must ensure that the data for all lanes arrives at all devices before the release point occurs.

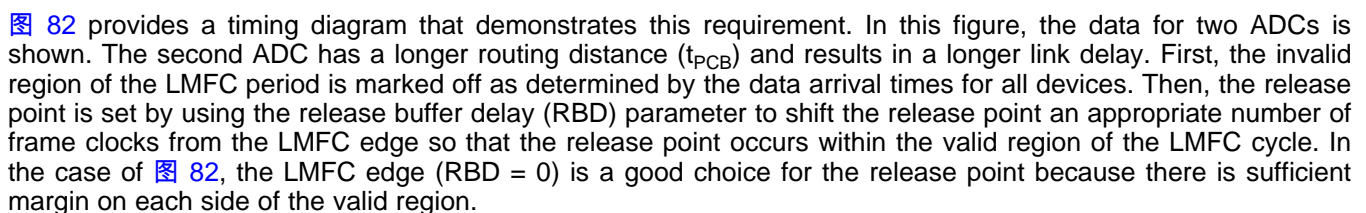
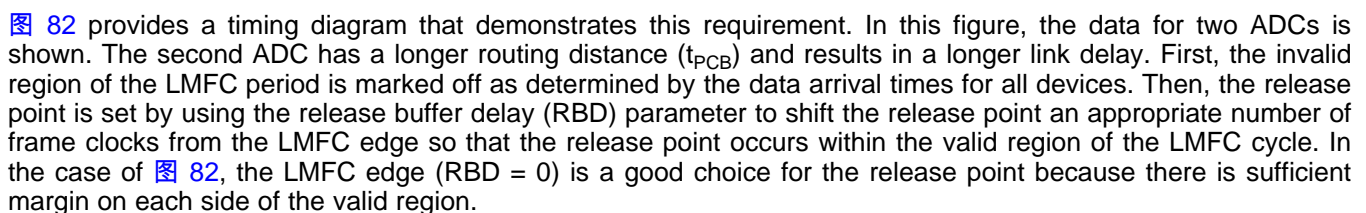
 82 provides a timing diagram that demonstrates this requirement. In this figure, the data for two ADCs is shown. The second ADC has a longer routing distance ( $t_{PCB}$ ) and results in a longer link delay. First, the invalid region of the LMFC period is marked off as determined by the data arrival times for all devices. Then, the release point is set by using the release buffer delay (RBD) parameter to shift the release point an appropriate number of frame clocks from the LMFC edge so that the release point occurs within the valid region of the LMFC cycle. In the case of  82, the LMFC edge (RBD = 0) is a good choice for the release point because there is sufficient margin on each side of the valid region.

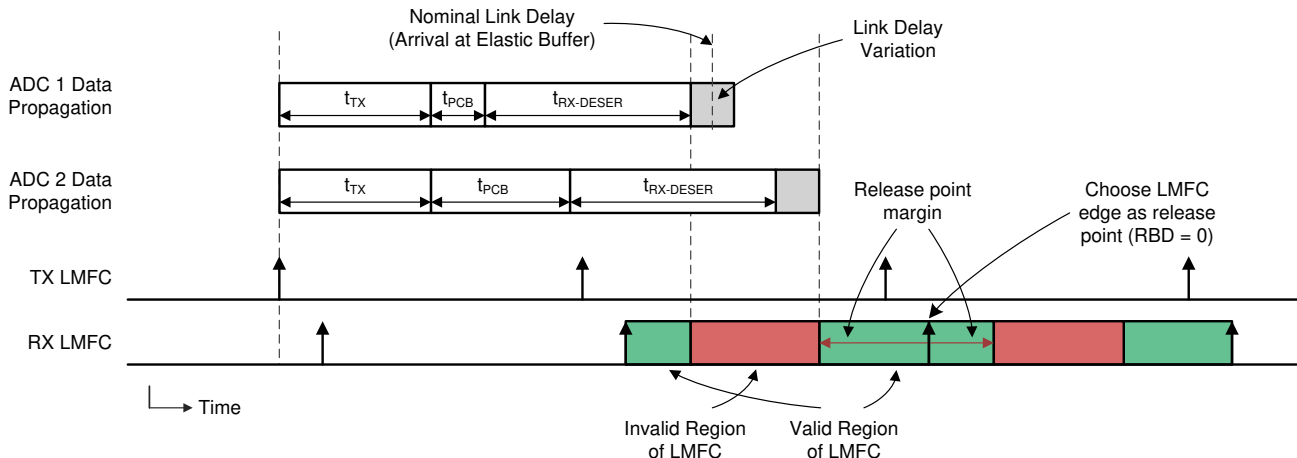

**图 82. LMFC Valid Region Definition for Elastic Buffer Release Point Selection**

The TX and RX LMFCs do not necessarily need to be phase aligned, but knowledge of their phase is important for proper elastic buffer release point selection. Also, the elastic buffer release point occurs within every LMFC cycle, but the buffers only release when all lanes have arrived. Therefore, the total link delay can exceed a single LMFC period; see [JESD204B multi-device synchronization: Breaking down the requirements](#) for more information.

### 7.3.8.7 Operation in Subclass 0 Systems

The ADC12DJ3200 can operate with subclass 0 compatibility provided that multi-ADC synchronization and deterministic latency are not required. With these limitations, the device can operate without the application of SYSREF. The internal local multiframe clock is automatically self-generated with unknown timing. SYNC is used as normal to initiate the CGS and ILA.

### 7.3.9 Alarm Monitoring

A number of built-in alarms are available to monitor internal events. Several types of alarms and upsets are detected by this feature:

1. Serializer PLL is not locked
2. JESD204B link is not transmitting data (not in the data transmission state)
3. SYSREF causes internal clocks to be realigned
4. An upset that impacts the NCO
5. An upset that impacts the internal clocks

When an alarm occurs, a bit for each specific alarm is set in ALM\_STATUS. Each alarm bit remains set until the host system writes a 1 to clear the alarm. If the alarm type is not masked (see the [alarm mask register](#)), then the alarm is also indicated by the ALARM register. The CALSTAT output pin can be configured as an alarm output that goes high when an alarm occurs; see the CAL\_STATUS\_SEL bit in the [calibration pin configuration register](#).

#### 7.3.9.1 NCO Upset Detection

The NCO\_ALM register bit indicates if the NCO in channel A or B has been upset. The NCO phase accumulators in channel A are continuously compared to channel B. If the accumulators differ for even one clock cycle, the NCO\_ALM register bit is set and remains set until cleared by the host system by writing a 1. This feature requires the phase and frequency words for each NCO accumulator in DDC A (PHASEAx, FREQAx) to be set to the same values as the NCO accumulators in DDC B (PHASEBx, FREQBx). For example, PHASEA0 must be the same as PHASEB0 and FREQA0 must be the same as FREQB0, however, PHASEA1 can be set to a different value than PHASEA0. This requirement ultimately reduces the number of NCO frequencies available for phase coherent frequency hopping from four to two for each DDC. DDC B can use a different NCO frequency than DDC A by setting the NCOB[1:0] pins to a different value than NCOA[1:0]. This detection is only valid after the NCOs are synchronized by either SYSREF or the start of the ILA sequence (as determined by the [NCO synchronization register](#)). For the NCO upset detection to work properly, follow these steps:

1. Program JESD\_EN = 0
2. Ensure the device is configured to use both channels (PD\_ACH = 0, PD\_BCH = 0)
3. Select a JMODE that uses the NCO
4. Program all NCO frequencies and phases to be the same for channel A and B (for example, FREQA0 = FREQB0, FREQA1 = FREQB1, FREQA2 = FREQB2, and FREQA3 = FREQB3)
5. If desired, use the CMODE and CSEL registers or the NCOA[1:0] and NCOB[1:0] pins to choose a unique frequency for channel A and channel B
6. Program JESD\_EN = 1
7. Synchronize the NCOs (using the ILA or using SYSREF); see the [NCO synchronization register](#)
8. Write a 1 to the NCO\_ALM register bit to clear it
9. Monitor the NCO\_ALM status bit or the CALSTAT output pin if CAL\_STATUS\_SEL is properly configured
10. If the frequency or phase registers are changed while the NCO is enabled, the NCOs can get out of synchronization
11. Repeat steps 7-9
12. If the device enters and exits global power down, repeat steps 7-9

### 7.3.9.2 Clock Upset Detection

The CLK\_ALM register bit indicates if the internal clocks have been upset. The clocks in channel A are continuously compared to channel B. If the clocks differ for even one DEVCLK / 2 cycle, the CLK\_ALM register bit is set and remains set until cleared by the host system by writing a 1. For the CLK\_ALM register bit to function properly, follow these steps:

1. Program JESD\_EN = 0
2. Ensure the part is configured to use both channels (PD\_ACH = 0, PD\_BCH = 0)
3. Program JESD\_EN = 1
4. Write CLK\_ALM = 1 to clear CLK\_ALM
5. Monitor the CLK\_ALM status bit or the CALSTAT output pin if CAL\_STATUS\_SEL is properly configured
6. When exiting global power-down (via MODE or the PD pin), the CLK\_ALM status bit may be set and must be cleared by writing a 1 to CLK\_ALM



## 7.4 Device Functional Modes

The ADC12DJ3200 can be configured to operate in a number of functional modes. These modes are described in this section.

### 7.4.1 Dual-Channel Mode

The ADC12DJ3200 can be used as a dual-channel ADC where the sampling rate is equal to the clock frequency ( $f_s = f_{CLK}$ ) provided at the CLK+ and CLK– pins. The two inputs, INA± and INB±, serve as the respective inputs for each channel in this mode. This mode is chosen simply by setting JMODE to the appropriate setting for the desired configuration as described in 表 19. The analog inputs can be swapped by setting DUAL\_INPUT (see the [input mux control register](#))

### 7.4.2 Single-Channel Mode (DES Mode)

The ADC12DJ3200 can also be used as a single-channel ADC where the sampling rate is equal to two times the clock frequency ( $f_s = 2 \times f_{CLK}$ ) provided at the CLK+ and CLK– pins. This mode effectively interleaves the two ADC channels together to form a single-channel ADC at twice the sampling rate. This mode is chosen simply by setting JMODE to the appropriate setting for the desired configuration as described in 表 19. Either analog input, INA± or INB±, can serve as the input to the ADC, however INA± is recommended for best performance. The analog input can be selected using SINGLE\_INPUT (see the [input mux control register](#)). The digital down-converters cannot be used in single-channel mode.

注

INA± is strongly recommended to be used as the input to the ADC for optimized performance in single-channel mode.

### 7.4.3 JESD204B Modes

The ADC12DJ3200 can be programmed as a single-channel or dual-channel ADC, with or without decimation, and a number JESD204B output formats. 表 17 summarizes the basic operating mode configuration parameters and whether they are user configured or derived.

注

Powering down high-speed data outputs (DA0± ... DA7±, DB0± ... DB7±) for extended times can reduce performance of the output serializers, especially at high data rates. For information regarding reliable serializer operation, see the [Power-Down Modes](#) section.

**表 17. ADC12DJ3200 Operating Mode Configuration Parameters**

PARAMETER	DESCRIPTION	USER CONFIGURED OR DERIVED	VALUE
JMODE	JESD204B operating mode, automatically derives the rest of the JESD204B parameters, single-channel or dual-channel mode and the decimation factor	User configured	Set by JMODE (see the <a href="#">JESD204B mode register</a> )
D	Decimation factor	Derived	See 表 19
DES	1 = single-channel mode, 0 = dual-channel mode	Derived	See 表 19
R	Number of bits transmitted per lane per DEVCLK cycle. The JESD204B line rate is the DEVCLK frequency times R. This parameter sets the SerDes PLL multiplication factor or controls bypassing of the SerDes PLL.	Derived	See 表 19
Links	Number of JESD204B links used	Derived	See 表 19
K	Number of frames per multiframe	User configured	Set by KM1 (see the <a href="#">JESD204B K parameter register</a> ), see the allowed values in 表 19

There are a number of parameters required to define the JESD204B format, all of which are sent across the link during the initial lane alignment sequence. In the ADC12DJ3200, most parameters are automatically derived based on the selected JMODE; however, a few are configured by the user. [表 18](#) describes these parameters.

**表 18. JESD204B Initial Lane Alignment Sequence Parameters**

PARAMETER	DESCRIPTION	USER CONFIGURED OR DERIVED	VALUE
ADJCNT	LMFC adjustment amount (not applicable)	Derived	Always 0
ADJDIR	LMFC adjustment direction (not applicable)	Derived	Always 0
BID	Bank ID	Derived	Always 0
CF	Number of control words per frame	Derived	Always 0
CS	Control bits per sample	Derived	Always set to 0 in ILAS, see <a href="#">表 19</a> for actual usage
DID	Device identifier, used to identify the link	User configured	Set by DID (see the <a href="#">JESD204B DID parameter register</a> ), see <a href="#">表 20</a>
F	Number of octets (bytes) per frame (per lane)	Derived	See <a href="#">表 19</a>
HD	High-density format (samples split between lanes)	Derived	Always 0
JESDV	JESD204 standard revision	Derived	Always 1
K	Number of frames per multiframe	User configured	Set by the KM1 register, see the <a href="#">JESD204B K parameter register</a>
L	Number of serial output lanes per link	Derived	See <a href="#">表 19</a>
LID	Lane identifier for each lane	Derived	See <a href="#">表 20</a>
M	Number of converters used to determine lane bit packing; may not match number of ADC channels in the device	Derived	See <a href="#">表 19</a>
N	Sample resolution (before adding control and tail bits)	Derived	See <a href="#">表 19</a>
N'	Bits per sample after adding control and tail bits	Derived	See <a href="#">表 19</a>
S	Number of samples per converter (M) per frame	Derived	See <a href="#">表 19</a>
SCR	Scrambler enabled	User configured	Set by the <a href="#">JESD204B control register</a>
SUBCLASSV	Device subclass version	Derived	Always 1
RES1	Reserved field 1	Derived	Always 0
RES2	Reserved field 2	Derived	Always 0
CHKSUM	Checksum for ILAS checking (sum of all above parameters modulo 256)	Derived	Computed based on parameters in this table

Configuring the ADC12DJ3200 is made easy by using a single configuration parameter called JMODE (see the [JESD204B mode register](#)). Using [表 19](#), the correct JMODE value can be found for the desired operating mode. The modes listed in [表 19](#) are the only available operating modes. This table also gives a range and allowable step size for the K parameter (set by KM1, see the [JESD204B K parameter register](#)), which sets the multiframe length in number of frames.

**表 19. ADC12DJ3200 Operating Modes**

ADC12DJ3200 OPERATING MODE	USER-SPECIFIED PARAMETER		DERIVED PARAMETERS											INPUT CLOCK RANGE (MHz)
	JMODE	K [Min:Step:Max]	D	DES	LINKS	N	CS	N'	L (Per Link)	M (Per Link)	F	S	R (Fbit / Fclk)	
12-bit, single-channel, 8 lanes	0	3:1:32	1	1	2	12	0	12	4	4 <sup>(1)</sup>	8	5	4	800-3200
12-bit, single-channel, 16 lanes	1	3:1:32	1	1	2	12	0	12	8	8 <sup>(1)</sup>	8	5	2	800-3200
12-bit, dual-channel, 8 lanes	2	3:1:32	1	0	2	12	0	12	4	4 <sup>(1)</sup>	8	5	4	800-3200
12-bit, dual-channel, 16 lanes	3	3:1:32	1	0	2	12	0	12	8	8 <sup>(1)</sup>	8	5	2	800-3200
8-bit, single-channel, 4 lanes	4	18:2:32	1	1	2	8	0	8	2	1	1	2	5	800-2560
8-bit, single-channel, 8 lanes	5	18:2:32	1	1	2	8	0	8	4	1	1	4	2.5	800-3200
8-bit, dual-channel, 4 lanes	6	18:2:32	1	0	2	8	0	8	2	1	1	2	5	800-2560
8-bit, dual-channel, 8 lanes	7	18:2:32	1	0	2	8	0	8	4	1	1	4	2.5	800-3200
Reserved	8	—	—	—	—	—	—	—	—	—	—	—	—	—
15-bit, real data, decimate-by-2, 8 lanes	9	9:1:32	2	0	2	15	1 <sup>(2)</sup>	16	4	1	2	4	2.5	800-3200
15-bit, decimate-by-4, 4 lanes	10	9:1:32	4	0	2	15	1 <sup>(2)</sup>	16	2	2	2	1	5	800-2560
15-bit, decimate-by-4, 8 lanes	11	9:1:32	4	0	2	15	1 <sup>(2)</sup>	16	4	2	2	2	2.5	800-3200
12-bit, decimate-by-4, 16 lanes	12	3:1:32	4	0	2	12	0	12	8	8 <sup>(1)</sup>	8	5	1	1000-3200
15-bit, decimate-by-8, 2 lanes	13	5:1:32	8	0	2	15	1 <sup>(2)</sup>	16	1	2	4	1	5	800-2560
15-bit, decimate-by-8, 4 lanes	14	9:1:32	8	0	2	15	1 <sup>(2)</sup>	16	2	2	2	1	2.5	800-3200
15-bit, decimate-by-16, 1 lane	15	3:1:32	16	0	1	15	1 <sup>(2)</sup>	16	1	4	8	1	5	800-2560
15-bit, decimate-by-16, 2 lanes	16	5:1:32	16	0	2	15	1 <sup>(2)</sup>	16	1	2	4	1	2.5	800-3200
8-bit, single-channel, 16 lanes	17	18:2:32	1	1	2	8	0	8	8	1	1	8	1.25	800-3200
8-bit, dual-channel, 16 lanes	18	18:2:32	1	0	2	8	0	8	8	1	1	8	1.25	800-3200

- (1) M equals L in these modes to allow the samples to be sent in time-order over L lanes. The M parameter does not represent the actual number of converters. Interleave the M sample streams from each link in the receiver to produce the correct sample data; see 表 21 to 表 38 for more details.
- (2) CS is always reported as 0 in the initial lane alignment sequence (ILAS) for the ADC12DJ3200.

The ADC12DJ3200 has a total of 16 high-speed output drivers that are grouped into two 8-lane JESD204B links. Most operating modes use two links with up to eight lanes per link. The lanes and their derived configuration parameters are described in 表 20. For a specified JMODE, the lowest indexed lanes for each link are used and the higher indexed lanes for each link are automatically powered down. Always route the lowest indexed lanes to the logic device.

**表 20. ADC12DJ3200 Lane Assignment and Parameters**

DEVICE PIN DESIGNATION	LINK	DID (User Configured)	LID (Derived)
DA0±	A	Set by DID (see the <a href="#">JESD204B DID parameter register</a> ), the effective DID is equal to the DID register setting (DID)	0
DA1±			1
DA2±			2
DA3±			3
DA4±			4
DA5±			5
DA6±			6
DA7±			7
DB0±	B	Set by DID (see the <a href="#">JESD204B DID parameter register</a> ), the effective DID is equal to the DID register setting plus 1 (DID+1)	0
DB1±			1
DB2±			2
DB3±			3
DB4±			4
DB5±			5
DB6±			6
DB7±			7

#### 7.4.3.1 JESD204B Output Data Formats

Output data are formatted in a specific optimized fashion for each JMODE setting. When the DDC is not used (decimation = 1) the 12-bit offset binary values are mapped into octets. For the DDC mode, the 16-bit values (15-bit complex data plus 1 overrange bit) are mapped into octets. The following tables show the specific mapping formats for a single frame. In all mappings the tail bits (T) are 0 (zero). In 表 21 to 表 38, the single-channel format samples are defined as  $S_n$ , where  $n$  is the sample number within the frame. In the dual-channel real output formats (DDC bypass and decimate-by-2), the samples are defined as  $A_n$  and  $B_n$ , where  $A_n$  are samples from channel A and  $B_n$  are samples from channel B. In the complex output formats (decimate-by-4, decimate-by-8, decimate-by-16), the samples are defined as  $A_{In}$ ,  $A_{Qn}$ ,  $B_{In}$  and  $B_{Qn}$ , where  $A_{In}$  and  $A_{Qn}$  are the in-phase and quadrature-phase samples of channel A and  $B_{In}$  and  $B_{Qn}$  are the in-phase and quadrature-phase samples of channel B. All samples are formatted as MSB first, LSB last.

**表 21. JMODE 0 (12-bit, Decimate-by-1, Single-Channel, 8 Lanes)**

OCTET	0		1		2		3		4		5		6		7		
NIBBLE	0	1	2	3	4	5	6	7	8	9	10	11	12	13	14	15	
DA0	S0				S8				S16				S24				T
DA1	S2				S10				S18				S26				T
DA2	S4				S12				S20				S28				T
DA3	S6				S14				S22				S30				T
DB0	S1				S9				S17				S25				T
DB1	S3				S11				S19				S27				T
DB2	S5				S13				S21				S29				T
DB3	S7				S15				S23				S31				T

**表 22. JMODE 1 (12-Bit, Decimate-by-1, Single-Channel, 16 Lanes)**

OCTET	0		1		2		3		4		5		6		7		
NIBBLE	0	1	2	3	4	5	6	7	8	9	10	11	12	13	14	15	
DA0	S0				S16				S32				S48				T
DA1	S2				S18				S34				S50				T
DA2	S4				S20				S36				S52				T
DA3	S6				S22				S38				S54				T
DA4	S8				S24				S40				S56				T
DA5	S10				S26				S42				S58				T
DA6	S12				S28				S44				S60				T
DA7	S14				S30				S46				S62				T
DB0	S1				S17				S33				S49				T
DB1	S3				S19				S35				S51				T
DB2	S5				S21				S37				S53				T
DB3	S7				S23				S39				S55				T
DB4	S9				S25				S41				S57				T
DB5	S11				S27				S43				S59				T
DB6	S13				S29				S45				S61				T
DB7	S15				S31				S47				S63				T

**表 23. JMODE 2 (12-Bit, Decimate-by-1, Dual-Channel, 8 Lanes)**

OCTET	0		1		2		3		4		5		6		7		
NIBBLE	0	1	2	3	4	5	6	7	8	9	10	11	12	13	14	15	
DA0	A0				A4				A8				A12				T
DA1	A1				A5				A9				A13				T
DA2	A2				A6				A10				A14				T
DA3	A3				A7				A11				A15				T
DB0	B0				B4				B8				B12				T
DB1	B1				B5				B9				B13				T
DB2	B2				B6				B10				B14				T
DB3	B3				B7				B11				B15				T

**表 24. JMODE 3 (12-Bit, Decimate-by-1, Dual-Channel, 16 Lanes)**

OCTET	0		1		2		3		4		5		6		7	
NIBBLE	0	1	2	3	4	5	6	7	8	9	10	11	12	13	14	15
DA0	A0		A8		A16		A24		A32		A40		A48		T	
DA1	A1		A9		A17		A25		A33		A41		A49		T	
DA2	A2		A10		A18		A26		A34		A42		A50		T	
DA3	A3		A11		A19		A27		A35		A43		A51		T	
DA4	A4		A12		A20		A28		A36		A44		A52		T	
DA5	A5		A13		A21		A29		A37		A45		A53		T	
DA6	A6		A14		A22		A30		A38		A46		A54		T	
DA7	A7		A15		A23		A31		A39		A47		A55		T	
DB0	B0		B8		B16		B24		B32		B40		B48		T	
DB1	B1		B9		B17		B25		B33		B41		B49		T	
DB2	B2		B10		B18		B26		B34		B42		B50		T	
DB3	B3		B11		B19		B27		B35		B43		B51		T	
DB4	B4		B12		B20		B28		B36		B44		B52		T	
DB5	B5		B13		B21		B29		B37		B45		B53		T	
DB6	B6		B14		B22		B30		B38		B46		B54		T	
DB7	B7		B15		B23		B31		B39		B47		B55		T	

**表 25. JMODE 4 (8-Bit, Decimate-by-1, Single-Channel, 4 Lanes)**

OCTET	0	
NIBBLE	0	1
DA0	S0	
DA1	S2	
DB0	S1	
DB1	S3	

**表 26. JMODE 5 (8-Bit, Decimate-by-1, Single-Channel, 8 Lanes)**

OCTET	0	
NIBBLE	0	1
DA0	S0	
DA1	S2	
DA2	S4	
DA3	S6	
DB0	S1	
DB1	S3	
DB2	S5	
DB3	S7	

**表 27. JMODE 6 (8-Bit, Decimate-by-1, Dual-Channel, 4 Lanes)**

OCTET	0	
NIBBLE	0	1
DA0	A0	
DA1	A1	
DB0	B0	
DB1	B1	

**表 28. JMODE 7 (8-Bit, Decimate-by-1, Dual-Channel, 8 Lanes)**

OCTET	0	
NIBBLE	0	1
DA0	A0	
DA1	A1	
DA2	A2	
DA3	A3	
DB0	B0	
DB1	B1	
DB2	B2	
DB3	B3	

**表 29. JMODE 9 (15-Bit, Decimate-by-2, Dual-Channel, 8 Lanes)**

OCTET	0		1	
NIBBLE	0	1	2	3
DA0	A0			
DA1	A1			
DA2	A2			
DA3	A3			
DB0	B0			
DB1	B1			
DB2	B2			
DB3	B3			

**表 30. JMODE 10 (15-Bit, Decimate-by-4, Dual-Channel, 4 Lanes)**

OCTET	0		1	
NIBBLE	0	1	2	3
DA0	AI0			
DA1	AQ0			
DB0	BI0			
DB1	BQ0			

**表 31. JMODE 11 (15-Bit, Decimate-by-4, Dual-Channel, 8 Lanes)**

OCTET	0		1	
NIBBLE	0	1	2	3
DA0	AI0			
DA1	AI1			
DA2	AQ0			
DA3	AQ1			
DB0	BI0			
DB1	BI1			
DB2	BQ0			
DB3	BQ1			

**表 32. JMODE 12 (12-Bit, Decimate-by-4, Dual-Channel, 16 Lanes)**

OCTET	0		1		2		3		4		5		6		7		
NIBBLE	0	1	2	3	4	5	6	7	8	9	10	11	12	13	14	15	
DA0	AI0				AI4				AI8				AI12		AI16		T
DA1	AQ0				AQ4				AQ8				AQ12		AQ16		T
DA2	AI1				AI5				AI9				AI13		AI17		T
DA3	AQ1				AQ5				AQ9				AQ13		AQ17		T
DA4	AI2				AI6				AI10				AI14		AI18		T
DA5	AQ2				AQ6				AQ10				AQ14		AQ218		T
DA6	AI3				AI7				AI11				AI15		AI19		T
DA7	AQ3				AQ7				AQ11				AQ15		AQ19		T
DB0	BI0				BI4				BI8				BI12		BI16		T
DB1	BQ0				BQ4				BQ8				BQ12		BQ16		T
DB2	BI1				BI5				BI9				BI13		BI17		T
DB3	BQ1				BQ5				BQ9				BQ13		BQ17		T
DB4	BI2				BI6				BI10				BI14		BI18		T
DB5	BQ2				BQ6				BQ10				BQ14		BQ218		T
DB6	BI3				BI7				BI11				BI15		BI19		T
DB7	BQ3				BQ7				BQ11				BQ15		BQ19		T

**表 33. JMODE 13 (15-Bit, Decimate-by-8, Dual-Channel, 2 Lanes)**

OCTET	0			1			2			3		
NIBBLE	0	1	2	3	4	5	6	7				
DA0	AI0						AQ0					
DB0	BI0						BQ0					

**表 34. JMODE 14 (15-Bit, Decimate-by-8, Dual-Channel, 4 Lanes)**

OCTET	0			1		
NIBBLE	0	1	2	3		
DA0	AI0					
DA1	AQ0					
DB0	BI0					
DB1	BQ0					

**表 35. JMODE 15 (15-Bit, Decimate-by-16, Dual-Channel, 1 Lane)**

OCTET	0		1		2		3		4		5		6		7	
NIBBLE	0	1	2	3	4	5	6	7	8	9	10	11	12	13	14	15
DA0	AI0				AQ0				BI0				BQ0			

**表 36. JMODE 16 (15-Bit, Decimate-by-16, Dual-Channel, 2 Lanes)**

OCTET	0			1			2			3		
NIBBLE	0	1	2	3	4	5	6	7				
DA0	AI0						AQ0					
DB0	BI0						BQ0					



**表 37. JMODE 17 (8-bit, Decimate-by-1, Single-Channel, 16 lanes)**

OCTET	0	
NIBBLE	0	1
DA0	S0	
DA1	S2	
DA2	S4	
DA3	S6	
DA4	S8	
DA5	S10	
DA6	S12	
DA7	S14	
DB0	S1	
DB1	S3	
DB2	S5	
DB3	S7	
DB4	S9	
DB5	S11	
DB6	S13	
DB7	S15	

**表 38. JMODE 18 (8-Bit, Decimate-by-1, Dual-Channel, 16 Lanes)**

OCTET	0	
NIBBLE	0	1
DA0	A0	
DA1	A1	
DA2	A2	
DA3	A3	
DA4	A4	
DA5	A5	
DA6	A6	
DA7	A7	
DB0	B0	
DB1	B1	
DB2	B2	
DB3	B3	
DB4	B4	
DB5	B5	
DB6	B6	
DB7	B7	

#### 7.4.3.2 Dual DDC and Redundant Data Mode

When operating in dual-channel mode, the data from one channel can be routed to both digital down-converter blocks by using DIG\_BIND\_A or DIG\_BIND\_B (see the [digital channel binding register](#)). This feature enables down-conversion of two separate captured bands from a single ADC channel. The second ADC can be powered down in this mode by setting PD\_ACH or PD\_BCH (see the [device configuration register](#)).

Additionally, DIG\_BIND\_A or DIG\_BIND\_B can be used to provide redundant data to separate digital processors by routing data from one ADC channel to both JESD204B links. Redundant data mode is available for all JMODE modes except for the single-channel modes. Both dual DDC mode and redundant data mode are demonstrated in [图 83](#) where the data for ADC channel A is routed to both DDCs and then transmitted to a single processor or two processors (for redundancy).



图 83. Dual DDC Mode or Redundant Data Mode for Channel A

#### 7.4.4 Power-Down Modes

The PD input pin allows the ADC12DJ3200 devices to be entirely powered down. Power-down can also be controlled by MODE (see the [device configuration register](#)). The serial data output drivers are disabled when PD is high. When the device returns to normal operation, the JESD204 link must be re-established, and the ADC pipeline and decimation filters contain meaningless information so the system must wait a sufficient time for the data to be flushed. If power-down for power savings is desired, the system must power down the supply voltages regulators for VA19, VA11, and VD11 rather than make use of the PD input or MODE settings.

#### CAUTION

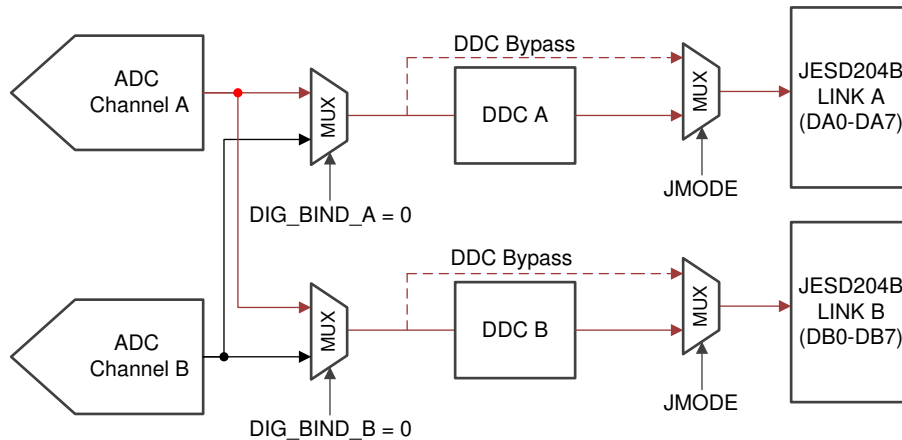
Powering down the high-speed data outputs (DA0± ... DA7±, DB0± ... DB7±) for extended times may damage the output serializers, especially at high data rates. Powering down the serializers occurs when the PD pin is held high, the MODE register is programmed to a value other than 0x00 or 0x01, the PD\_ACH or PD\_BCH registers settings are programmed to 1, or when the JMODE register setting is programmed to a mode that uses less than the 16 total lanes that the device allows. For instance, JMODE 0 uses eight total lanes and therefore the four highest-indexed lanes for each JESD204B link (DA4± ... DA7±, DB4± ... DB7±) are powered down in this mode. When the PD pin is held high or the MODE register is programmed to a value other than 0x00 or 0x01, all output serializers are powered down. When the PD\_ACH or PD\_BCH register settings are programmed to 1, the associated ADC channel and lanes are powered down. To prevent unreliable operation, the PD pin and MODE register must only be used for brief periods of time to measure temperature diode offsets and not used for long-term power savings. Furthermore, using a JMODE that uses fewer than 16 lanes results in unreliable operation of the unused lanes. If the system never uses the unused lanes during the lifetime of the device, then the unused lanes do not cause issues and can be powered down. If the system may make use of the unused lanes at a later time, the reliable operation of the serializer outputs can be maintained by enabling JEXTRA\_A and JEXTRA\_B, which results in the VD11 power consumption to increase and the output serializers to toggle.

#### 7.4.5 Test Modes

A number of device test modes are available. These modes insert known patterns of information into the device data path for assistance with system debug, development, or characterization.

### 7.4.5.1 Serializer Test-Mode Details

Test modes are enabled by setting JTEST (see the [JESD204B test pattern control register](#)) to the desired test mode. Each test mode is described in detail in the following sections. Regardless of the test mode, the serializer outputs are powered up based on JMODE. Only enable the test modes when the JESD204B link is disabled. [图 84](#) provides a diagram showing the various test mode insertion points.



图 84. Test Mode Insertion Points

### 7.4.5.2 PRBS Test Modes

The PRBS test modes bypass the 8b, 10b encoder. These test modes produce pseudo-random bit streams that comply with the ITU-T O.150 specification. These bit streams are used with lab test equipment that can self-synchronize to the bit pattern and, therefore, the initial phase of the pattern is not defined.

The sequences are defined by a recursive equation. For example, [公式 10](#) defines the PRBS7 sequence.

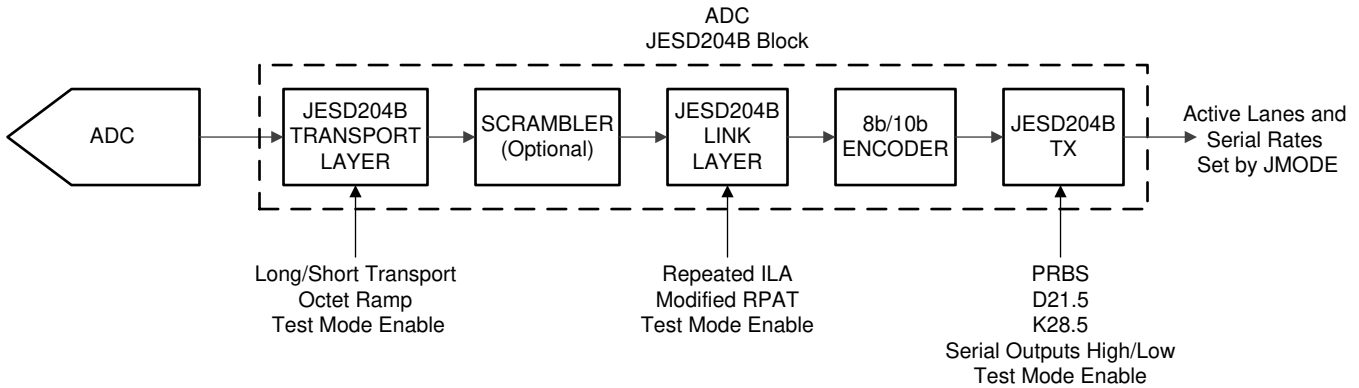
$$y[n] = y[n - 6] \oplus y[n - 7]$$

where

- bit n is the XOR of bit [n - 6] and bit [n - 7], which are previously transmitted bits (10)

[表 39](#) lists equations and sequence lengths for the available PRBS test modes. The initial phase of the pattern is unique for each lane.

表 39. PRBS Mode Equations

PRBS TEST MODE	SEQUENCE	SEQUENCE LENGTH (bits)
PRBS7	$y[n] = y[n - 6] \oplus y[n - 7]$	127
PRBS15	$y[n] = y[n - 14] \oplus y[n - 15]$	32767
PRBS23	$y[n] = y[n - 18] \oplus y[n - 23]$	8388607

### 7.4.5.3 Ramp Test Mode

In the ramp test mode, the JESD204B link layer operates normally, but the transport layer is disabled and the input from the formatter is ignored. After the ILA sequence, each lane transmits an identical octet stream that increments from 0x00 to 0xFF and repeats.

### 7.4.5.4 Short and Long Transport Test Mode

JESD204B defines both short and long transport test modes to verify that the transport layers in the transmitter and receiver are operating correctly. The ADC12DJ3200 has three different transport layer test patterns depending on the N' value of the specified JMODE (see [表 19](#)).

**7.4.5.4.1 Short Transport Test Pattern**

Short transport test patterns send a predefined octet format that repeats every frame. In the ADC12DJ3200, all JMODE configurations that have an N' value of 8 or 12 use the short transport test pattern. 表 40 and 表 41 define the short transport test patterns for N' values of 8 and 12. All applicable lanes are shown, however only the enabled lanes (lowest indexed) for the configured JMODE are used.

**表 40. Short Transport Test Pattern for N' = 8 Modes (Length = 2 Frames)**

FRAME	0	1
DA0	0x00	0xFF
DA1	0x01	0xFE
DA2	0x02	0xFD
DA3	0x03	0xFC
DB0	0x00	0xFF
DB1	0x01	0xFE
DB2	0x02	0xFD
DB3	0x03	0xFC

**表 41. Short Transport Test Pattern for N' = 12 Modes (Length = 1 Frame)**

OCTET	0		1		2		3		4		5		6		7	
NIBBLE	0	1	2	3	4	5	6	7	8	9	10	11	12	13	14	15
DA0	0xF01		0xF02		0xF03		0xF04		0xF05		0xF06		0xF07		T	
DA1	0xE11		0xE12		0xE13		0xE14		0xE15		0xE16		0xE17		T	
DA2	0xD21		0xD22		0xD23		0xD24		0xD25		0xD26		0xD27		T	
DA3	0xC31		0xC32		0xC33		0xC34		0xC35		0xC36		0xC37		T	
DA4	0xB41		0xB42		0xB43		0xB44		0xB45		0xB46		0xB47		T	
DA5	0xA51		0xA52		0xA53		0xA54		0xA55		0xA56		0xA57		T	
DA6	0x961		0x962		0x963		0x964		0x965		0x966		0x967		T	
DA7	0x871		0x872		0x873		0x874		0x875		0x876		0x877		T	
DB0	0xF01		0xF02		0xF03		0xF04		0xF05		0xF06		0xF07		T	
DB1	0xE11		0xE12		0xE13		0xE14		0xE15		0xE16		0xE17		T	
DB2	0xD21		0xD22		0xD23		0xD24		0xD25		0xD26		0xD27		T	
DB3	0xC31		0xC32		0xC33		0xC34		0xC35		0xC36		0xC37		T	
DB4	0xB41		0xB42		0xB43		0xB44		0xB45		0xB46		0xB47		T	
DB5	0xA51		0xA52		0xA53		0xA54		0xA55		0xA56		0xA57		T	
DB6	0x961		0x962		0x963		0x964		0x965		0x966		0x967		T	
DB7	0x871		0x872		0x873		0x874		0x875		0x876		0x877		T	

#### 7.4.5.4.2 Long Transport Test Pattern

The long-transport test mode is used in all of the JMODE modes where N' equals 16. Patterns are generated in accordance with the JESD204B standard and are different for each output format as defined in 表 19. The rules for the pattern are defined below. 公式 11 gives the length of the test pattern. The long transport test pattern is the same for link A and link B, where DAx lanes belong to link A and DBx lanes belong to link B.

$$\text{Long Test Pattern Length (Frames)} = K \times \text{ceil}[(M \times S + 2) / K] \quad (11)$$

- Sample Data:
  - Frame 0: Each sample contains N bits, with all samples set to the converter ID (CID) plus 1 (CID + 1). The CID is defined based on the converter number within the link; two links are used in all modes except JMODE 15. Within a link, the converters are numbered by channel (A or B) and in-phase (I) and quadrature-phase (Q) and reset between links. For instance, in JMODE 10, two links are used so channel A and B data are separated into separate links and the in-phase component for each channel has CID = 0 and the quadrature-phase component has CID = 1. In JMODE 15, one link is used, so channel A and B are within the same link and AI has CID = 0, AQ has CID = 1, BI has CID = 2, and BQ has CID = 3.
  - Frame 1: Each sample contains N bits, with each sample (for each converter) set as its individual sample ID (SID) within the frame plus 1 (SID + 1)
  - Frame 2 +: Each sample contains N bits, with the data set to  $2^{N-1}$  for all samples (for example, if N is 15 then  $2^{N-1} = 16384$ )
- Control Bits (if  $\overline{CS} > 0$ ):
  - Frame 0 to  $M \times S - 1$ : The control bit belonging to the sample mod (i, S) of the converter floor (i, S) is set to 1 and all others are set to 0, where i is the frame index (i = 0 is the first frame of the pattern). Essentially, the control bit *walks* from the lowest indexed sample to the highest indexed sample and from the lowest indexed converter to the highest indexed converter, changing position every frame.
  - Frame  $M \times S +$ : All control bits are set to 0

表 42 describes an example long transport test pattern for when JMODE = 10, K = 10.

**表 42. Example Long Transport Test Pattern (JMODE = 10, K = 10)**

OCTET NUM	TIME →																PATTERN REPEATS →					
	0	1	2	3	4	5	6	7	8	9	10	11	12	13	14	15	16	17	18	19	20	21
DA0	0x0003		0x0002		0x8000		0x8000		0x8000		0x8000		0x8000		0x8000		0x8000		0x8000		0x0003	
DA1	0x0004		0x0003		0x8000		0x8000		0x8000		0x8000		0x8000		0x8000		0x8000		0x8000		0x0004	
DB0	0x0003		0x0002		0x8000		0x8000		0x8000		0x8000		0x8000		0x8000		0x8000		0x8000		0x0003	
DB1	0x0004		0x0003		0x8000		0x8000		0x8000		0x8000		0x8000		0x8000		0x8000		0x8000		0x0004	
	Frame n		Frame n + 1		Frame n + 2		Frame n + 3		Frame n + 4		Frame n + 5		Frame n + 6		Frame n + 7		Frame n + 8		Frame n + 9		Frame n + 10	

The pattern starts at the end of the initial lane alignment sequence (ILAS) and repeats indefinitely as long as the link remains running. For more details see the JESD204B specification, section 5.1.6.3.

#### 7.4.5.5 D21.5 Test Mode

In this test mode, the controller transmits a continuous stream of D21.5 characters (alternating 0s and 1s).

#### 7.4.5.6 K28.5 Test Mode

In this test mode, the controller transmits a continuous stream of K28.5 characters.

#### 7.4.5.7 Repeated ILA Test Mode

In this test mode, the JESD204B link layer operates normally, except that the ILA sequence (ILAS) repeats indefinitely instead of starting the data phase. Whenever the receiver issues a synchronization request, the transmitter initiates code group synchronization. Upon completion of code group synchronization, the transmitter repeatedly transmits the ILA sequence.

### 7.4.5.8 Modified RPAT Test Mode

A 12-octet repeating pattern is defined in INCITS TR-35-2004. The purpose of this pattern is to generate white spectral content for JESD204B compliance and jitter testing. 表 43 lists the pattern before and after 8b, 10b encoding.

**表 43. Modified RPAT Pattern Values**

OCTET NUMBER	Dx.y NOTATION	8-BIT INPUT TO 8b, 10b ENCODER	20b OUTPUT OF 8b, 10b ENCODER (Two Characters)
0	D30.5	0xBE	0x86BA6
1	D23.6	0xD7	
2	D3.1	0x23	0xC6475
3	D7.2	0x47	
4	D11.3	0x6B	0xD0E8D
5	D15.4	0x8F	
6	D19.5	0xB3	0xCA8B4
7	D20.0	0x14	
8	D30.2	0x5E	0x7949E
9	D27.7	0xFB	
10	D21.1	0x35	0xAA665
11	D25.2	0x59	

### 7.4.6 Calibration Modes and Trimming

The ADC12DJ3200 has two calibration modes available: foreground calibration and background calibration. When foreground calibration is initiated the ADCs are automatically taken offline and the output data becomes mid-code (0x000 in 2's complement) while a calibration is occurring. Background calibration allows the ADC to continue normal operation while the ADC cores are calibrated in the background by swapping in a different ADC core to take its place. Additional offset calibration features are available in both foreground and background calibration modes. Further, a number of ADC parameters can be trimmed to optimize performance in a user system.

The ADC12DJ3200 consists of a total of six sub-ADCs, each referred to as a *bank*, with two banks forming an *ADC core*. The banks sample out-of-phase so that each ADC core is two-way interleaved. The six banks form three ADC cores, referred to as ADC A, ADC B, and ADC C. In foreground calibration mode, ADC A samples  $INA_{\pm}$  and ADC B samples  $INB_{\pm}$  in dual-channel mode and both ADC A and ADC B sample  $INA_{\pm}$  (or  $INB_{\pm}$ ) in single-channel mode. In the background calibration modes, the third ADC core, ADC C, is swapped in periodically for ADC A and ADC B so that they can be calibrated without disrupting operation. 图 85 provides a diagram of the calibration system including labeling of the banks that make up each ADC core. When calibration is performed the linearity, gain, and offset voltage for each bank are calibrated to an internally generated calibration signal. The analog inputs can be driven during calibration, both foreground and background, except that when offset calibration (OS\_CAL or BGOS\_CAL) is used there must be no signals (or aliased signals) near DC for proper estimation of the offset (see the [Offset Calibration](#) section).

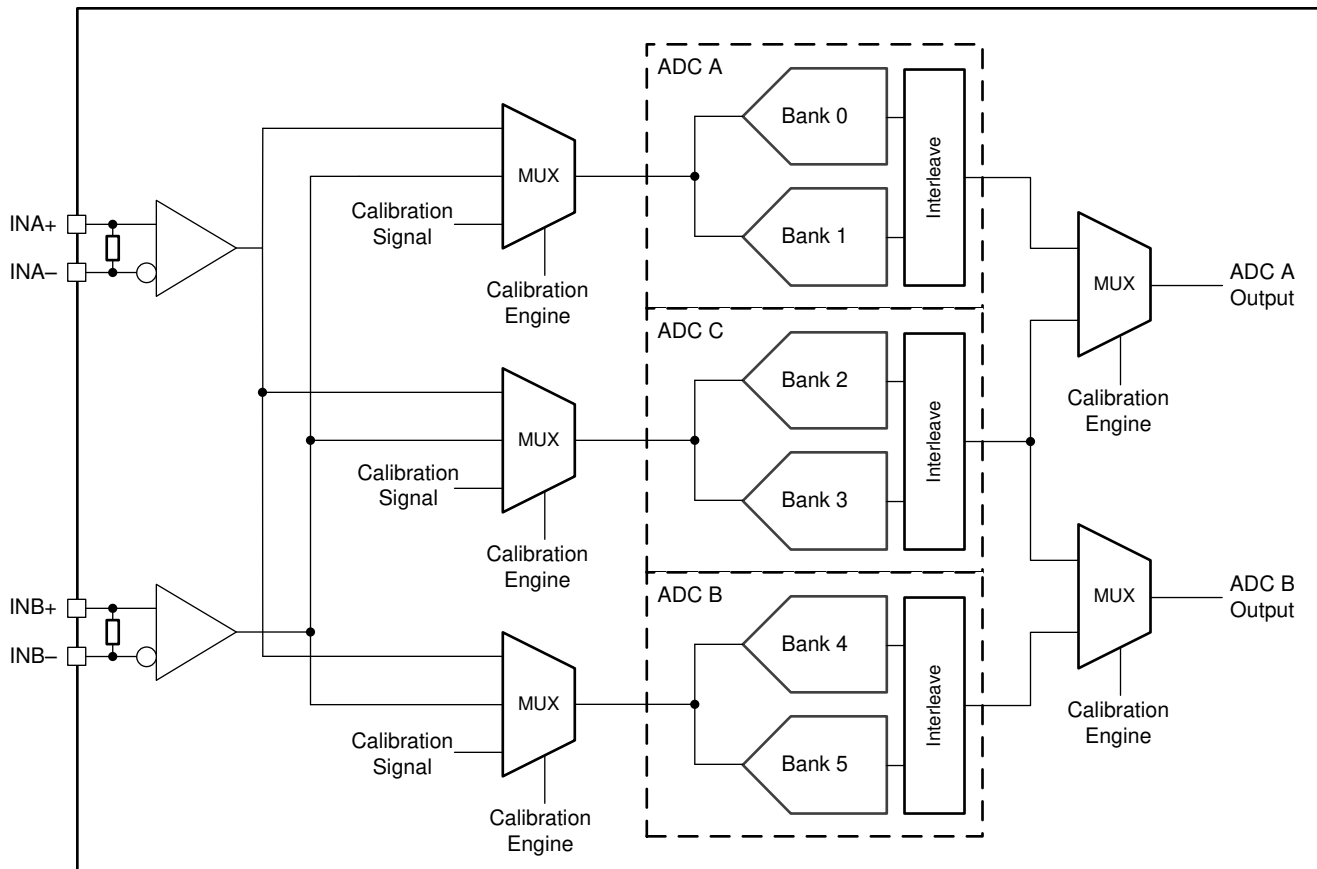

**图 85. ADC12DJ3200 Calibration System Block Diagram**

In addition to calibration, a number of ADC parameters are user controllable to provide trimming for optimal performance. These parameters include input offset voltage, ADC gain, interleaving timing, and input termination resistance. The default trim values are programmed at the factory to unique values for each device that are determined to be optimal at the test system operating conditions. The user can read the factory-programmed values from the trim registers and adjust as desired. The register fields that control the trimming are labeled according to the input that is being sampled ( $\text{INA}\pm$  or  $\text{INB}\pm$ ), the bank that is being trimmed, or the ADC core that is being trimmed. The user is not expected to change the trim values as operating conditions change, however optimal performance can be obtained by doing so. Any custom trimming must be done on a per device basis because of process variations, meaning that there is no global optimal setting for all parts. See the [Trimming](#) section for information about the available trim parameters and associated registers.

#### 7.4.6.1 Foreground Calibration Mode

Foreground calibration requires the ADC to stop converting the analog input signals during the procedure. Foreground calibration always runs on power-up and the user must wait a sufficient time before programming the device to ensure that the calibration is finished. Foreground calibration can be initiated by triggering the calibration engine. The trigger source can be either the CAL\_TRIG pin or CAL\_SOFT\_TRIG (see the [calibration software trigger register](#)) and is chosen by setting CAL\_TRIG\_EN (see the [calibration pin configuration register](#)).

#### 7.4.6.2 Background Calibration Mode

Background calibration mode allows the ADC to continuously operate, with no interruption of data. This continuous operation is accomplished by activating an extra ADC core that is calibrated and then takes over operation for one of the other previously active ADC cores. When that ADC core is taken off-line, that ADC is calibrated and can in turn take over to allow the next ADC to be calibrated. This process operates continuously, ensuring the ADC cores always provide the optimum performance regardless of system operating condition changes. Because of the additional active ADC core, background calibration mode has increased power



consumption in comparison to foreground calibration mode. The low-power background calibration (LPBG) mode discussed in the [Low-Power Background Calibration \(LPBG\) Mode](#) section provides reduced average power consumption in comparison with the standard background calibration mode. Background calibration can be enabled by setting CAL\_BG (see the [calibration configuration 0 register](#)). CAL\_TRIG\_EN must be set to 0 and CAL\_SOFT\_TRIG must be set to 1.

Great care has been taken to minimize effects on converted data as the core switching process occurs, however, small brief glitches may still occur on the converter data as the cores are swapped. See the [Typical Characteristics](#) section for examples of possible glitches in sine-wave and DC signals.

### 7.4.6.3 Low-Power Background Calibration (LPBG) Mode

Low-power background calibration (LPBG) mode reduces the power-overhead of enabling the additional ADC core while still allowing background calibration of the ADC cores to maintain optimal performance as operating conditions change. LPBG calibration modifies the background calibration procedure by powering down the spare ADC core until it is ready to be calibrated. Set LP\_EN = 1 to enable the low-power background calibration feature. Calibration and swapping of ADC cores can be controlled either automatically by the device or manually by the system by setting LP\_TRIG appropriately. Manual control (LP\_TRIG=1) allows the system to trigger calibration in order to limit the number of calibration cycles that occur to avoid unnecessary core swaps or to keep power consumption at a minimum. For instance, the user may decide to run calibration only when the system temperature changes by some fixed temperature. If manual control is not necessary the automatic calibration control can be enabled (LP\_TRIG=0) to calibrate at fixed time intervals.

In automatic calibration mode (LP\_TRIG=0) the spare ADC core sleep time can be controlled by the LP\_SLEEP\_DLY register setting. LP\_SLEEP\_DLY is used to adjust the amount of time an ADC sleeps before waking up for calibration (when LP\_EN=1 and LP\_TRIG = 0). LP\_WAKE\_DLY sets how long the core is allowed to stabilize after being awoken before calibration begins. In automatic calibration control mode the freshly calibrated core is swapped in for an active core as soon as calibration finishes and the new spare core is powered down for the sleep duration before waking up and calibrating.

Manual calibration control is enabled by setting LP\_TRIG high in order to use the calibration trigger (CAL\_SOFT\_TRIG or CALTRIG) to trigger calibrations and core swaps. When manual control is enabled (LP\_TRIG=1) the spare ADC is held in sleep mode while the calibration trigger is high. Setting the calibration trigger low then wakes up the spare ADC core and starts the calibration routine after waiting for the specified wake delay (LP\_WAKE\_DLY). The spare ADC core is swapped in for an active core once calibration is complete and the calibration trigger is set high again. If the calibration trigger is held low, then the spare ADC core calibrates and remains powered until the calibration trigger goes high; therefore consuming power. can report when the spare ADC finishes calibration on the CALSTAT output pin by setting the CALSTAT pin to output the CAL\_STOPPED signal (CAL\_STATUS\_SEL = 1). For lowest power consumption, set the calibration trigger high before calibration finishes to allow the spare ADC to swap in for an active ADC core as soon as calibration finishes. Otherwise, the ADC core swap can be timed manually by setting the calibration trigger high at the desired time to minimize system impact of potential glitches caused by the swapping procedure.

In LPBG mode there is an increase in power consumption during the ADC core calibration. The longer the spare ADC is held asleep the lower the average power consumption, however large shifts in operating conditions during the sleep cycle may cause degraded ADC performance due to non-optimized calibration data for the active ADC core. The power consumption roughly alternates between the power consumption in foreground calibration when the spare ADC core is sleeping to the power consumption in background calibration when the spare ADC is being calibrated. Design the power-supply network to handle the transient power requirements for this mode, including bulk capacitance after any power supply filtering network to help regulate the supply voltage during the supply transient.

### 7.4.7 Offset Calibration

Foreground calibration and background calibration modes inherently calibrate the offsets of the ADC cores; however, the input buffers sit outside of the calibration loop and therefore their offsets are not calibrated by the standard calibration process. In both dual-channel mode and single-channel mode, uncalibrated input buffer offsets result in a shift in the mid-code output (DC offset) with no input. Further, in single-channel mode uncalibrated input buffer offsets can result in a fixed spur at  $f_s / 2$ . A separate calibration is provided to correct the input buffer offsets.



There must be no signals at or near DC or aliased signals that fall at or near DC in order to properly calibration the offsets, requiring the system to ensure this condition during normal operation or have the ability to mute the input signal during calibration. Foreground offset calibration is enabled via CAL\_OS and only performs the calibration one time as part of the foreground calibration procedure. Background offset calibration is enabled via CAL\_BGOS and continues to correct the offset as part of the background calibration routine to account for operating condition changes. When CAL\_BGOS is set, the system must ensure that there are no DC or near DC signals or aliased signals that fall at or near DC during normal operation. Offset calibration can be performed as a foreground operation when using background calibration by setting CAL\_OS to 1 before setting CAL\_EN, but does not correct for variations as operating conditions change.

The offset calibration correction uses the input offset voltage trim registers (see [表 44](#)) to correct the offset and therefore must not be written by the user when offset calibration is used. The user can read the calibrated values by reading the OADJ\_x\_VINy registers, where x is the ADC core and y is the input (INA± or INB±), after calibration is completed. Only read the values when FG\_DONE is read as 1 when using foreground offset calibration (CAL\_OS = 1) and do not read the values when using background offset calibration (CAL\_BGOS = 1). Setting CAL\_OS to 1 and CAL\_BG to 1 performs an offset calibration of all three ADC cores during the foreground calibration process.

### 7.4.8 Trimming

表 44 lists the parameters that can be trimmed and the associated registers. User trimming is limited to foreground (FG) calibration only.

**表 44. Trim Register Descriptions**

TRIM PARAMETER	TRIM REGISTER	NOTES
Band-gap reference	BG_TRIM	Measurement on BG output pin.
Input termination resistance	RTRIM <sub>x</sub> , where x = A for INA± or B for INB±)	The device must be powered on with a clock applied.
Input offset voltage	OADJ <sub>x_VINy</sub> , where x = ADC core (A or B) and y = A for INA± or B for INB±)	Input offset adjustment in dual channel mode consists of changing OADJ <sub>A_VINA</sub> for channel A and OADJ <sub>B_VINB</sub> for channel B. In single channel mode, OADJ <sub>A_VINx</sub> and OADJ <sub>B_VINx</sub> must be adjusted together to trim the input offset or adjusted separate to compensate the $f_s/2$ offset spur.
INA± and INB± gain	GAIN_TRIM <sub>x</sub> , where x = A for INA± or B for INB±)	Set FS_RANGE <sub>A</sub> and FS_RANGE <sub>B</sub> to default values before trimming the input. Use FS_RANGE <sub>A</sub> and FS_RANGE <sub>B</sub> to adjust the full-scale input voltage. To trim the gain of ADC core A, change GAIN <sub>B0</sub> and GAIN <sub>B1</sub> together in the same direction. To trim the gain of ADC core B, change GAIN <sub>B4</sub> and GAIN <sub>B5</sub> together in the same direction. To trim the gain of the two banks within ADC A, change GAIN <sub>B0</sub> and GAIN <sub>B1</sub> in opposite directions. To trim the gain of the two banks within ADC B, change GAIN <sub>B4</sub> and GAIN <sub>B5</sub> in opposite directions.
INA± and INB± full-scale input voltage	FS_RANGE <sub>x</sub> , where x = A for INA± or B for INB±)	Full-scale input voltage adjustment for each input. The default value is effected by GAIN_TRIM <sub>x</sub> (x = A or B). Trim GAIN_TRIM <sub>x</sub> with FS_RANGE <sub>x</sub> set to the default value. FS_RANGE <sub>x</sub> can then be used to trim the full-scale input voltage.
Intra-ADC core timing (bank timing)	Bx_TIME <sub>y</sub> , where x = bank number (0, 1, 4 or 5) and y = 0° or –90° clock phase	Trims the timing between the two banks of an ADC core (ADC A or B). The 0° clock phase is used for dual channel mode and for ADC B in single channel mode. The –90° clock phase is used only for ADC A in single-channel mode. A mismatch in the timing between the two banks of an ADC core can result in an $f_s/2-f_{IN}$ spur in dual channel mode or $f_s/4 \pm f_{IN}$ spurs in single channel mode.
Inter-ADC core timing (dual-channel mode)	TADJ <sub>A</sub> , TADJ <sub>B</sub>	The suffix letter (A or B) indicates the ADC core that is being trimmed. Changing either TADJ <sub>A</sub> or TADJ <sub>B</sub> adjusts the sampling instance of ADC A relative to ADC B in dual channel mode.
Inter-ADC core timing (single-channel mode)	TADJ <sub>A_FG90</sub> , TADJ <sub>B_FG0</sub>	These trim registers are used to adjust the timing of ADC core A relative to ADC core B in single channel mode. A mismatch in the timing results in an $f_s/2-f_{IN}$ spur that is signal dependent. Changing either TADJ <sub>A_FG90</sub> or TADJ <sub>B_FG0</sub> changes the relative timing of ADC core A relative to ADC core B in single channel mode. These registers are trimmed at production to optimize performance for INA±.

### 7.4.9 Offset Filtering

The ADC12DJ3200 has an additional feature that can be enabled to reduce offset-related interleaving spurs at  $f_s / 2$  and  $f_s / 4$  (single input mode only). Offset filtering is enabled via CAL\_OSFILT. The OSFILT\_BW and OSFILT\_SOAK parameters can be adjusted to tradeoff offset spur reduction with potential impact on information in the mission mode signal being processed. Set these two parameters to the same value under most situations. The DC\_RESTORE setting is used to either retain or filter out all DC-related content in the signal. This feature implements a notch filter at  $f_s / 2$  and  $f_s / 4$  (single input mode only) and also filters out signals that fall at these frequency locations. Reducing the notch filter bandwidth using OSFILT\_BW can reduce the range of signals that are filtered by this feature.

## 7.5 Programming

### 7.5.1 Using the Serial Interface

The serial interface is accessed using the following four pins: serial clock (SCLK), serial data in (SDI), serial data out (SDO), and serial interface chip-select ( $\overline{\text{SCS}}$ ). Register access is enabled through the  $\overline{\text{SCS}}$  pin.

#### 7.5.1.1 $\overline{\text{SCS}}$

This signal must be asserted low to access a register through the serial interface. Setup and hold times with respect to the SCLK must be observed.

#### 7.5.1.2 SCLK

Serial data input is accepted at the rising edge of this signal. SCLK has no minimum frequency requirement.

#### 7.5.1.3 SDI

Each register access requires a specific 24-bit pattern at this input. This pattern consists of a read-and-write (R/W) bit, register address, and register value. The data are shifted in MSB first and multi-byte registers are always in little-endian format (least significant byte stored at the lowest address). Setup and hold times with respect to the SCLK must be observed (see the [Timing Requirements](#) table).

#### 7.5.1.4 SDO

The SDO signal provides the output data requested by a read command. This output is high impedance during write bus cycles and during the read bit and register address portion of read bus cycles.

As shown in [Figure 86](#), each register access consists of 24 bits. The first bit is high for a read and low for a write.

The next 15 bits are the address of the register that is to be written to. During write operations, the last eight bits are the data written to the addressed register. During read operations, the last eight bits on SDI are ignored and, during this time, the SDO outputs the data from the addressed register. [Figure 86](#) shows the serial protocol details.



图 86. Serial Interface Protocol: Single Read/Write

## Programming (接下页)

### 7.5.1.5 Streaming Mode

The serial interface supports streaming reads and writes. In this mode, the initial 24 bits of the transaction specifies the access type, register address, and data value as normal. Additional clock cycles of write or read data are immediately transferred, as long as the SCS input is maintained in the asserted (logic low) state. The register address auto increments (default) or decrements for each subsequent 8-bit transfer of the streaming transaction. The ADDR\_ASC bit (register 000h, bits 5 and 2) controls whether the address value ascends (increments) or descends (decrements). Streaming mode can be disabled by setting the ADDR\_HOLD bit (see the [user SPI configuration register](#)). 图 87 shows the streaming mode transaction details.

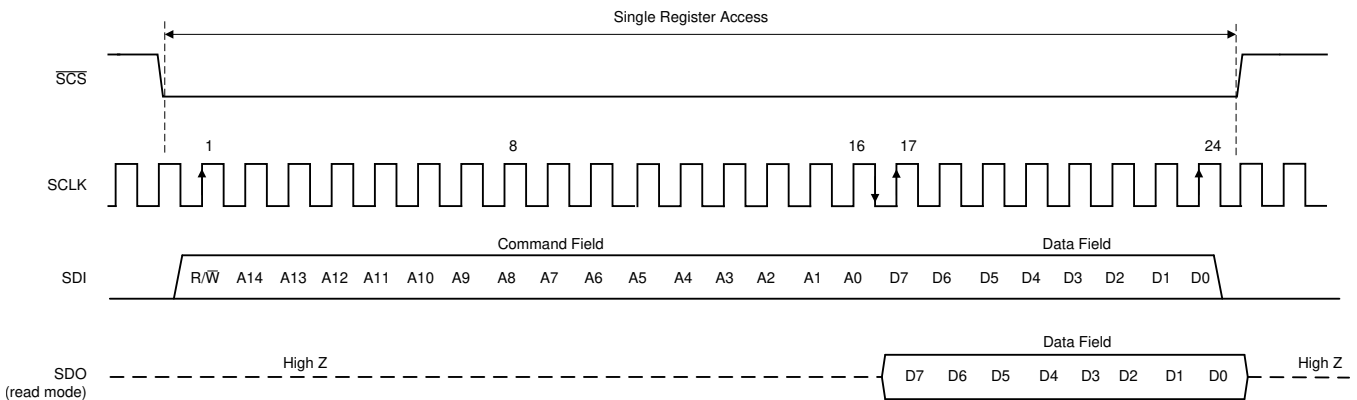

图 87. Serial Interface Protocol: Streaming Read/Write

See the [Register Maps](#) section for detailed information regarding the registers.

#### 注

The serial interface must not be accessed during ADC calibration. Accessing the serial interface during this time impairs the performance of the device until the device is calibrated correctly. Writing or reading the serial registers also reduces dynamic ADC performance for the duration of the register access time.

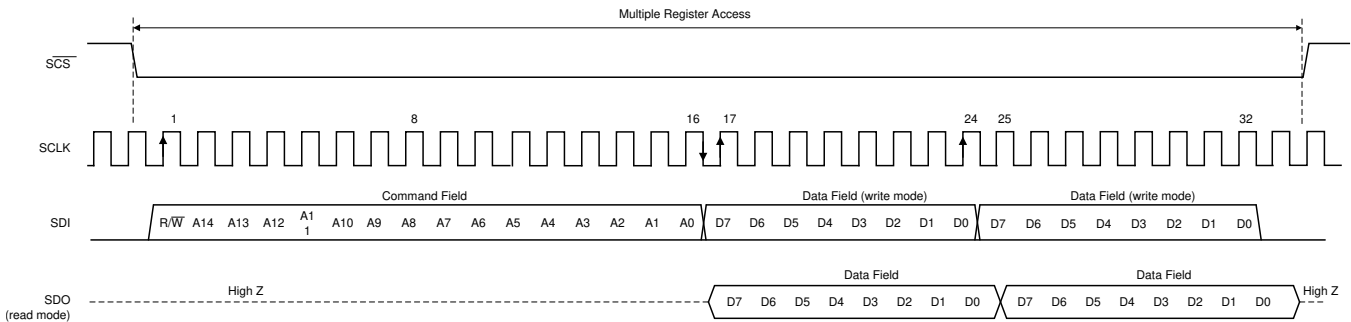
## 7.6 Register Maps

The [Memory Map](#) lists all the ADC12DJ3200 registers.

### Memory Map

ADDRESS	RESET	ACRONYM	TYPE	REGISTER NAME
<b>STANDARD SPI-3.0 (0x000 to 0x00F)</b>				
0x000	0x30	CONFIG_A	R/W	Configuration A Register
0x001	Undefined	RESERVED	R	RESERVED
0x002	0x00	DEVICE_CONFIG	R/W	Device Configuration Register
0x003	0x03	CHIP_TYPE	R	Chip Type Register
0x004-0x005	0x0020	CHIP_ID	R	Chip ID Registers
0x006	0x0A	CHIP_VERSION	R	Chip Version Register
0x007-0x00B	Undefined	RESERVED	R	RESERVED
0x00C-0x00D	0x0451	VENDOR_ID	R	Vendor Identification Register
0x00E-0x00F	Undefined	RESERVED	R	RESERVED
<b>USER SPI CONFIGURATION (0x010 to 0x01F)</b>				
0x010	0x00	USR0	R/W	User SPI Configuration Register
0x011-0x01F	Undefined	RESERVED	R	RESERVED

**Register Maps (continued)**
**Memory Map (continued)**

ADDRESS	RESET	ACRONYM	TYPE	REGISTER NAME
<b>MISCELLANEOUS ANALOG REGISTERS (0x020 to 0x047)</b>				
0x020-0x028	Undefined	RESERVED	R	RESERVED
0x029	0x00	CLK_CTRL0	R/W	Clock Control Register 0
0x02A	0x20	CLK_CTRL1	R/W	Clock Control Register 1
0x02B	Undefined	RESERVED	R	RESERVED
0x02C-0x02E	Undefined	SYSREF_POS	R	SYSREF Capture Position Register
0x02F	Undefined	RESERVED	R	RESERVED
0x030-0x031	0xA000	FS_RANGE_A	R/W	INA Full-Scale Range Adjust Register
0x032-0x033	0xA000	FS_RANGE_B	R/W	INB Full-Scale Range Adjust Register
0x034-0x037	Undefined	RESERVED	R	RESERVED
0x038	0x00	BG_BYPASS	R/W	Internal Reference Bypass Register
0x039-0x03A	Undefined	RESERVED	R	RESERVED
0x03B	0x00	TMSTP_CTRL	R/W	TMSTP± Control Register
0x03C-0x047	Undefined	RESERVED	R	RESERVED
<b>SERIALIZER REGISTERS (0x048 to 0x05F)</b>				
0x048	0x00	SER_PE	R/W	Serializer Pre-Emphasis Control Register
0x049-0x05F	Undefined	RESERVED	R	RESERVED
<b>CALIBRATION REGISTERS (0x060 to 0x0FF)</b>				
0x060	0x01	INPUT_MUX	R/W	Input Mux Control Register
0x061	0x01	CAL_EN	R/W	Calibration Enable Register
0x062	0x01	CAL_CFG0	R/W	Calibration Configuration 0 Register
0x063-0x069	Undefined	RESERVED	R	RESERVED
0x06A	Undefined	CAL_STATUS	R	Calibration Status Register
0x06B	0x00	CAL_PIN_CFG	R/W	Calibration Pin Configuration Register
0x06C	0x01	CAL_SOFT_TRIG	R/W	Calibration Software Trigger Register
0x06D	Undefined	RESERVED	R	RESERVED
0x06E	0x88	CAL_LP	R/W	Low-Power Background Calibration Register
0x06F	Undefined	RESERVED	R	RESERVED
0x070	0x00	CAL_DATA_EN	R/W	Calibration Data Enable Register
0x071	Undefined	CAL_DATA	R/W	Calibration Data Register
0x072-0x079	Undefined	RESERVED	R	RESERVED
0x07A	Undefined	GAIN_TRIM_A	R/W	Channel A Gain Trim Register
0x07B	Undefined	GAIN_TRIM_B	R/W	Channel B Gain Trim Register
0x07C	Undefined	BG_TRIM	R/W	Band-Gap Reference Trim Register
0x07D	Undefined	RESERVED	R	RESERVED
0x07E	Undefined	RTRIM_A	R/W	VINA Input Resistor Trim Register
0x07F	Undefined	RTRIM_B	R/W	VINB Input Resistor Trim Register
0x080	Undefined	TADJ_A_FG90	R/W	Timing Adjustment for A-ADC, Single-Channel Mode, Foreground Calibration Register
0x081	Undefined	TADJ_B_FG0	R/W	Timing Adjustment for B-ADC, Single-Channel Mode, Foreground Calibration Register
0x082	Undefined	TADJ_A_BG90	R/W	Timing Adjustment for A-ADC, Single-Channel Mode, Background Calibration Register
0x083	Undefined	TADJ_C_BG0	R/W	Timing Adjustment for C-ADC, Single-Channel Mode, Background Calibration Register
0x084	Undefined	TADJ_C_BG90	R/W	Timing Adjustment for C-ADC, Single-Channel Mode, Background Calibration Register

**Register Maps (continued)**
**Memory Map (continued)**

ADDRESS	RESET	ACRONYM	TYPE	REGISTER NAME
0x085	Undefined	TADJ_B_BG0	R/W	Timing Adjustment for B-ADC, Single-Channel Mode, Background Calibration Register
0x086	Undefined	TADJ_A	R/W	Timing Adjustment for A-ADC, Dual-Channel Mode Register
0x087	Undefined	TADJ_CA	R/W	Timing Adjustment for C-ADC Acting for A-ADC, Dual-Channel Mode Register
0x088	Undefined	TADJ_CB	R/W	Timing Adjustment for C-ADC Acting for B-ADC, Dual-Channel Mode Register
0x089	Undefined	TADJ_B	R/W	Timing Adjustment for B-ADC, Dual-Channel Mode Register
0x08A-0x08B	Undefined	OADJ_A_INA	R/W	Offset Adjustment for A-ADC and INA Register
0x08C-0x08D	Undefined	OADJ_A_INB	R/W	Offset Adjustment for A-ADC and INB Register
0x08E-0x08F	Undefined	OADJ_C_INA	R/W	Offset Adjustment for C-ADC and INA Register
0x090-0x091	Undefined	OADJ_C_INB	R/W	Offset Adjustment for C-ADC and INB Register
0x092-0x093	Undefined	OADJ_B_INA	R/W	Offset Adjustment for B-ADC and INA Register
0x094-0x095	Undefined	OADJ_B_INB	R/W	Offset Adjustment for B-ADC and INB Register
0x096	Undefined	RESERVED	R	RESERVED
0x097	0x00	OSFILT0	R/W	Offset Filtering Control 0
0x098	0x33	OSFILT1	R/W	Offset Filtering Control 1
0x099-0x0FF	Undefined	RESERVED	R	RESERVED
<b>ADC BANK REGISTERS (0x100 to 0x15F)</b>				
0x100-0x101	Undefined	RESERVED	R	RESERVED
0x102	Undefined	B0_TIME_0	R/W	Timing Adjustment for Bank 0 (0° Clock) Register
0x103	Undefined	B0_TIME_90	R/W	Timing Adjustment for Bank 0 (–90° Clock) Register
0x104-0x111	Undefined	RESERVED	R	RESERVED
0x112	Undefined	B1_TIME_0	R/W	Timing Adjustment for Bank 1 (0° Clock) Register
0x113	Undefined	B1_TIME_90	R/W	Timing Adjustment for Bank 1 (–90° Clock) Register
0x114-0x121	Undefined	RESERVED	R	RESERVED
0x122	Undefined	B2_TIME_0	R/W	Timing Adjustment for Bank 2 (0° Clock) Register
0x123	Undefined	B2_TIME_90	R/W	Timing Adjustment for Bank 2 (–90° Clock) Register
0x124-0x131	Undefined	RESERVED	R	RESERVED
0x132	Undefined	B3_TIME_0	R/W	Timing Adjustment for Bank 3 (0° Clock) Register
0x133	Undefined	B3_TIME_90	R/W	Timing Adjustment for Bank 3 (–90° Clock) Register
0x134-0x141	Undefined	RESERVED	R	RESERVED
0x142	Undefined	B4_TIME_0	R/W	Timing Adjustment for Bank 4 (0° Clock) Register
0x143	Undefined	B4_TIME_90	R/W	Timing Adjustment for Bank 4 (–90° Clock) Register
0x144-0x151	Undefined	RESERVED	R	RESERVED
0x152	Undefined	B5_TIME_0	R/W	Timing Adjustment for Bank 5 (0° Clock) Register
0x153	Undefined	B5_TIME_90	R/W	Timing Adjustment for Bank 5 (–90° Clock) Register
0x154-0x15F	Undefined	RESERVED	R	RESERVED
<b>LSB CONTROL REGISTERS (0x160 to 0x1FF)</b>				
0x160	0x00	ENC_LSB	R/W	LSB Control Bit Output Register
0x161-0x1FF	Undefined	RESERVED	R	RESERVED
<b>JESD204B REGISTERS (0x200 to 0x20F)</b>				
0x200	0x01	JESD_EN	R/W	JESD204B Enable Register
0x201	0x02	JMODE	R/W	JESD204B Mode (JMODE) Register
0x202	0x1F	KM1	R/W	JESD204B K Parameter Register
0x203	0x01	JSYNC_N	R/W	JESD204B Manual SYNC Request Register
0x204	0x02	JCTRL	R/W	JESD204B Control Register

**Register Maps (continued)**
**Memory Map (continued)**

ADDRESS	RESET	ACRONYM	TYPE	REGISTER NAME
0x205	0x00	JTEST	R/W	JESD204B Test Pattern Control Register
0x206	0x00	DID	R/W	JESD204B DID Parameter Register
0x207	0x00	FCHAR	R/W	JESD204B Frame Character Register
0x208	Undefined	JESD_STATUS	R/W	JESD204B, System Status Register
0x209	0x00	PD_CH	R/W	JESD204B Channel Power-Down
0x20A	0x00	JEXTRA_A	R/W	JESD204B Extra Lane Enable (Link A)
0x20B	0x00	JEXTRA_B	R/W	JESD204B Extra Lane Enable (Link B)
0x20C-0x20F	Undefined	RESERVED	R	RESERVED
<b>DIGITAL DOWN CONVERTER REGISTERS (0x210-0x2AF)</b>				
0x210	0x00	DDC_CFG	R/W	DDC Configuration Register
0x211	0xF2	OVR_T0	R/W	Overrange Threshold 0 Register
0x212	0xAB	OVR_T1	R/W	Overrange Threshold 1 Register
0x213	0x07	OVR_CFG	R/W	Overrange Configuration Register
0x214	0x00	CMODE	R/W	DDC Configuration Preset Mode Register
0x215	0x00	CSEL	R/W	DDC Configuration Preset Select Register
0x216	0x02	DIG_BIND	R/W	Digital Channel Binding Register
0x217-0x218	0x0000	NCO_RDIV	R/W	Rational NCO Reference Divisor Register
0x219	0x02	NCO_SYNC	R/W	NCO Synchronization Register
0x21A-0x21F	Undefined	RESERVED	R	RESERVED
0x220-0x223	0xC0000000	FREQA0	R/W	NCO Frequency (DDC A Preset 0)
0x224-0x225	0x0000	PHASEA0	R/W	NCO Phase (DDC A Preset 0)
0x226-0x227	Undefined	RESERVED	R	RESERVED
0x228-0x22B	0xC0000000	FREQA1	R/W	NCO Frequency (DDC A Preset 1)
0x22C-0x22D	0x0000	PHASEA1	R/W	NCO Phase (DDC A Preset 1)
0x22E-0x22F	Undefined	RESERVED	R	RESERVED
0x230-0x233	0xC0000000	FREQA2	R/W	NCO Frequency (DDC A Preset 2)
0x234-0x235	0x0000	PHASEA2	R/W	NCO Phase (DDC A Preset 2)
0x236-0x237	Undefined	RESERVED	R	RESERVED
0x238-0x23B	0xC0000000	FREQA3	R/W	NCO Frequency (DDC A Preset 3)
0x23C-0x23D	0x0000	PHASEA3	R/W	NCO Phase (DDC A Preset 3)
0x23E-0x23F	Undefined	RESERVED	R	RESERVED
0x240-0x243	0xC0000000	FREQB0	R/W	NCO Frequency (DDC B Preset 0)
0x244-0x245	0x0000	PHASEB0	R/W	NCO Phase (DDC B Preset 0)
0x246-0x247	Undefined	RESERVED	R	RESERVED
0x248-0x24B	0xC0000000	FREQB1	R/W	NCO Frequency (DDC B Preset 1)
0x24C-0x24D	0x0000	PHASEB1	R/W	NCO Phase (DDC B Preset 1)
0x24E-0x24F	Undefined	RESERVED	R	RESERVED
0x250-0x253	0xC0000000	FREQB2	R/W	NCO Frequency (DDC B Preset 2)
0x254-0x255	0x0000	PHASEB2	R/W	NCO Phase (DDC B Preset 2)
0x256-0x257	Undefined	RESERVED	R	RESERVED
0x258-0x25B	0xC0000000	FREQB3	R/W	NCO Frequency (DDC B Preset 3)
0x25C-0x25D	0x0000	PHASEB3	R/W	NCO Phase (DDC B Preset 3)
0x25E-0x296	Undefined	RESERVED	R	RESERVED
0x297	Undefined	SPIN_ID	R	Spin Identification Value
0x298-0x2AF	Undefined	RESERVED	R	RESERVED



**Register Maps (continued)**
**Memory Map (continued)**

ADDRESS	RESET	ACRONYM	TYPE	REGISTER NAME
<b>SYSREF CALIBRATION REGISTERS (0x2B0 to 0x2BF)</b>				
0x2B0	0x00	SRC_EN	R/W	SYSREF Calibration Enable Register
0x2B1	0x05	SRC_CFG	R/W	SYSREF Calibration Configuration Register
0x2B2-0x2B4	Undefined	SRC_STATUS	R	SYSREF Calibration Status
0x2B5-0x2B7	0x00	TAD	R/W	DEVCLK Aperture Delay Adjustment Register
0x2B8	0x00	TAD_RAMP	R/W	DEVCLK Timing Adjust Ramp Control Register
0x2B9-0x2BF	Undefined	RESERVED	R	RESERVED
<b>ALARM REGISTERS (0x2C0 to 0x2C2)</b>				
0x2C0	Undefined	ALARM	R	Alarm Interrupt Status Register
0x2C1	0x1F	ALM_STATUS	R/W	Alarm Status Register
0x2C2	0x1F	ALM_MASK	R/W	Alarm Mask Register

7.6.1 Register Descriptions

Table 45 lists the access codes for the ADC12DJ3200 registers.

Table 45. ADC12DJ3200 Access Type Codes

Access Type	Code	Description
R	R	Read
R-W	R/W	Read or write
W	W	Write
-n		Value after reset or the default value

7.6.1.1 Standard SPI-3.0 (0x000 to 0x00F)

Table 46. Standard SPI-3.0 Registers

ADDRESS	RESET	ACRONYM	REGISTER NAME	SECTION
0x000	0x30	CONFIG_A	Configuration A Register	Configuration A Register (address = 0x000) [reset = 0x30]
0x001	Undefined	RESERVED	RESERVED	—
0x002	0x00	DEVICE_CONFIG	Device Configuration Register	Device Configuration Register (address = 0x002) [reset = 0x00]
0x003	0x03	CHIP_TYPE	Chip Type Register	Chip Type Register (address = 0x003) [reset = 0x03]
0x004-0x005	0x0020	CHIP_ID	Chip ID Registers	Chip ID Register (address = 0x004 to 0x005) [reset = 0x0020]
0x006	0x0A	CHIP_VERSION	Chip Version Register	Chip Version Register (address = 0x006) [reset = 0x0A]
0x007-0x00B	Undefined	RESERVED	RESERVED	—
0x00C-0x00D	0x0451	VENDOR_ID	Vendor Identification Register	Vendor Identification Register (address = 0x00C to 0x00D) [reset = 0x0451]
0x00E-0x00F	Undefined	RESERVED	RESERVED	—

7.6.1.1.1 Configuration A Register (address = 0x000) [reset = 0x30]

Figure 88. Configuration A Register (CONFIG\_A)

7	6	5	4	3	2	1	0
SOFT_RESET	RESERVED	ADDR_ASC	SDO_ACTIVE	RESERVED			
R/W-0	R-0	R/W-1	R-1	R-0000			

Table 47. CONFIG\_A Field Descriptions

Bit	Field	Type	Reset	Description
7	SOFT_RESET	R/W	0	Setting this bit results in a full reset of the device. This bit is self-clearing. After writing this bit, the device may take up to 750 ns to reset. During this time, do not perform any SPI transactions.
6	RESERVED	R	0	RESERVED
5	ADDR_ASC	R/W	1	0: Descend – decrement address while streaming reads/writes 1: Ascend – increment address while streaming reads/writes (default)
4	SDO_ACTIVE	R	1	Always returns 1, indicating that the device always uses 4-wire SPI mode.
3-0	RESERVED	R	0000	RESERVED

**7.6.1.1.2 Device Configuration Register (address = 0x002) [reset = 0x00]**
**Figure 89. Device Configuration Register (DEVICE\_CONFIG)**

7	6	5	4	3	2	1	0
RESERVED						MODE	
R-0000 00						R/W-00	

**Table 48. DEVICE\_CONFIG Field Descriptions**

Bit	Field	Type	Reset	Description
7-2	RESERVED	R	0000 00	RESERVED
1-0	MODE	R/W	00	The SPI 3.0 specification lists 1 as the low-power functional mode, 2 as the low-power fast resume, and 3 as power-down. This device does not support these modes. 0: Normal operation – full power and full performance (default) 1: Normal operation – full power and full performance 2: Power down - everything is powered down. Only use this setting for brief periods of time to calibrate the on-chip temperature diode measurement. See the <a href="#">Recommended Operating Conditions</a> table for more information. 3: Power down - everything is powered down. Only use this setting for brief periods of time to calibrate the on-chip temperature diode measurement. See the <a href="#">Recommended Operating Conditions</a> table for more information.

**7.6.1.1.3 Chip Type Register (address = 0x003) [reset = 0x03]**
**Figure 90. Chip Type Register (CHIP\_TYPE)**

7	6	5	4	3	2	1	0
RESERVED				CHIP_TYPE			
R-0000				R-0011			

**Table 49. CHIP\_TYPE Field Descriptions**

Bit	Field	Type	Reset	Description
7-4	RESERVED	R	0000	RESERVED
3-0	CHIP_TYPE	R	0011	Always returns 0x3, indicating that the device is a high-speed ADC.

**7.6.1.1.4 Chip ID Register (address = 0x004 to 0x005) [reset = 0x0020]**
**Figure 91. Chip ID Register (CHIP\_ID)**

15	14	13	12	11	10	9	8
CHIP_ID[15:8]							
R-0x00h							
7	6	5	4	3	2	1	0
CHIP_ID[7:0]							
R-0x20h							

**Table 50. CHIP\_ID Field Descriptions**

Bit	Field	Type	Reset	Description
15-0	CHIP_ID	R	0x0020h	Always returns 0x0020, indicating that this device is an ADC12DJ3200 .

7.6.1.1.5 Chip Version Register (address = 0x006) [reset = 0x01]

Figure 92. Chip Version Register (CHIP\_VERSION)

7	6	5	4	3	2	1	0
CHIP_VERSION							
R-0000 1010							

Table 51. CHIP\_VERSION Field Descriptions

Bit	Field	Type	Reset	Description
7-0	CHIP_VERSION	R	0000 1010	Chip version, returns 0x0A.

7.6.1.1.6 Vendor Identification Register (address = 0x00C to 0x00D) [reset = 0x0451]

Figure 93. Vendor Identification Register (VENDOR\_ID)

15	14	13	12	11	10	9	8
VENDOR_ID[15:8]							
R-0x04h							
7	6	5	4	3	2	1	0
VENDOR_ID[7:0]							
R-0x51h							

Table 52. VENDOR\_ID Field Descriptions

Bit	Field	Type	Reset	Description
15-0	VENDOR_ID	R	0x0451h	Always returns 0x0451 (TI vendor ID).

7.6.1.2 User SPI Configuration (0x010 to 0x01F)

Table 53. User SPI Configuration Registers

ADDRESS	RESET	ACRONYM	REGISTER NAME	SECTION
0x010	0x00	USR0	User SPI Configuration Register	User SPI Configuration Register (address = 0x010) [reset = 0x00]
0x011-0x01F	Undefined	RESERVED	RESERVED	—

7.6.1.2.1 User SPI Configuration Register (address = 0x010) [reset = 0x00]

Figure 94. User SPI Configuration Register (USR0)

7	6	5	4	3	2	1	0
RESERVED							ADDR_HOLD
R-0000 000							R/W-0

Table 54. USR0 Field Descriptions

Bit	Field	Type	Reset	Description
7-1	RESERVED	R/W	0000 000	RESERVED
0	ADDR_HOLD	R/W	0	0: Use the ADDR_ASC bit to define what happens to the address during streaming (default) 1: Address remains static throughout streaming operation; this setting is useful for reading/writing calibration vector information at the CAL_DATA register

7.6.1.3 Miscellaneous Analog Registers (0x020 to 0x047)

Table 55. Miscellaneous Analog Registers

ADDRESS	RESET	ACRONYM	REGISTER NAME	SECTION
0x020-0x028	Undefined	RESERVED	RESERVED	—
0x029	0x00	CLK_CTRL0	Clock Control Register 0	Clock Control Register 0 (address = 0x029) [reset = 0x00]
0x02A	0x20	CLK_CTRL1	Clock Control Register 1	Clock Control Register 1 (address = 0x02A) [reset = 0x00]
0x02B	Undefined	RESERVED	RESERVED	—
0x02C-0x02E	Undefined	SYSREF_POS	SYSREF Capture Position Register	SYSREF Capture Position Register (address = 0x02C-0x02E) [reset = Undefined]
0x02F	Undefined	RESERVED	RESERVED	—
0x030-0x031	0xA000	FS_RANGE_A	INA Full-Scale Range Adjust Register	INA Full-Scale Range Adjust Register (address = 0x030-0x031) [reset = 0xA000]
0x032-0x033	0xA000	FS_RANGE_B	INB Full-Scale Range Adjust Register	INB Full-Scale Range Adjust Register (address = 0x032-0x033) [reset = 0xA000]
0x034-0x037	Undefined	RESERVED	RESERVED	—
0x038	0x00	BG_BYPASS	Internal Reference Bypass Register	Internal Reference Bypass Register (address = 0x038) [reset = 0x00]
0x039-0x03A	Undefined	RESERVED	RESERVED	—
0x03B	0x00	SYNC_CTRL	TMSTP± Control Register	TMSTP± Control Register (address = 0x03B) [reset = 0x00]
0x03C-0x047	Undefined	RESERVED	RESERVED	—

7.6.1.3.1 Clock Control Register 0 (address = 0x029) [reset = 0x00]

Figure 95. Clock Control Register 0 (CLK\_CTRL0)

7	6	5	4	3	2	1	0
RESERVED	SYSREF_PROC_EN	SYSREF_RECV_EN	SYSREF_ZOOM	SYSREF_SEL			
R/W-0	R/W-0	R/W-0	R/W-0	R/W-0000			

Table 56. CLK\_CTRL0 Field Descriptions

Bit	Field	Type	Reset	Description
7	RESERVED	R/W	0	RESERVED
6	SYSREF_PROC_EN	R/W	0	This bit enables the SYSREF processor. This bit must be set to allow the device to process SYSREF events. SYSREF_RECV_EN must be set before setting SYSREF_PROC_EN.
5	SYSREF_RECV_EN	R/W	0	Set this bit to enable the SYSREF receiver circuit.
4	SYSREF_ZOOM	R/W	0	Set this bit to zoom in the SYSREF strobe status (affects SYSREF_POS).
3-0	SYSREF_SEL	R/W	0000	Set this field to select which SYSREF delay to use. Set this field based on the results returned by SYSREF_POS. Set this field to 0 to use SYSREF calibration.

7.6.1.3.2 Clock Control Register 1 (address = 0x02A) [reset = 0x00]

Figure 96. Clock Control Register 1 (CLK\_CTRL1)

7	6	5	4	3	2	1	0
RESERVED				DEVCLK_LVPECL_EN		SYSREF_LVPECL_EN	SYSREF_INVERTED
R/W-0010 0				R/W-0		R/W-0	R/W-0

Table 57. CLK\_CTRL1 Field Descriptions

Bit	Field	Type	Reset	Description
7-3	RESERVED	R/W	0010 0	RESERVED
2	DEVCLK_LVPECL_EN	R/W	0	Activate low-voltage PECL mode for DEVCLK.
1	SYSREF_LVPECL_EN	R/W	0	Activate low-voltage PECL mode for SYSREF.
0	SYSREF_INVERTED	R/W	0	Inverts the SYSREF signal used for alignment.

7.6.1.3.3 SYSREF Capture Position Register (address = 0x02C-0x02E) [reset = Undefined]

Figure 97. SYSREF Capture Position Register (SYSREF\_POS)

23	22	21	20	19	18	17	16
SYSREF_POS[23:16]							
R-Undefined							
15	14	13	12	11	10	9	8
SYSREF_POS[15:8]							
R-Undefined							
7	6	5	4	3	2	1	0
SYSREF_POS[7:0]							
R-Undefined							

Table 58. SYSREF\_POS Field Descriptions

Bit	Field	Type	Reset	Description
23-0	SYSREF_POS	R	Undefined	This field returns a 24-bit status value that indicates the position of the SYSREF edge with respect to DEVCLK. Use this field to program SYSREF_SEL.

7.6.1.3.4 INA Full-Scale Range Adjust Register (address = 0x030-0x031) [reset = 0xA000]

Figure 98. INA Full-Scale Range Adjust Register (FS\_RANGE\_A)

15	14	13	12	11	10	9	8
FS_RANGE_A[15:8]							
R/W-0xA0h							
7	6	5	4	3	2	1	0
FS_RANGE_A[7:0]							
R/W-0x00h							

Table 59. FS\_RANGE\_A Field Descriptions

Bit	Field	Type	Reset	Description
15-0	FS_RANGE_A	R/W	0xA000h	This field enables adjustment of the analog full-scale range for INA. 0x0000: Settings below 0x2000 may result in degraded device performance 0x2000: 500 mV <sub>PP</sub> - Recommended minimum setting 0xA000: 800 mV <sub>PP</sub> (default) 0xFFFF: 1000 mV <sub>PP</sub>

7.6.1.3.5 INB Full-Scale Range Adjust Register (address = 0x032-0x033) [reset = 0xA000]

Figure 99. INB Full Scale Range Adjust Register (FS\_RANGE\_B)

15	14	13	12	11	10	9	8
FS_RANGE_B[15:8]							
R/W-0xA0							
7	6	5	4	3	2	1	0
FS_RANGE_B[7:0]							
R/W-0x00							

Table 60. FS\_RANGE\_B Field Descriptions

Bit	Field	Type	Reset	Description
15-0	FS_RANGE_B	R/W	0xA000h	This field enables adjustment of the analog full-scale range for INB. 0x0000: Settings below 0x2000 may result in degraded device performance 0x2000: 500 mV <sub>PP</sub> - Recommended minimum setting 0xA000: 800 mV <sub>PP</sub> (default) 0xFFFF: 1000 mV <sub>PP</sub>

7.6.1.3.6 Internal Reference Bypass Register (address = 0x038) [reset = 0x00]

Figure 100. Internal Reference Bypass Register (BG\_BYPASS)

7	6	5	4	3	2	1	0
RESERVED							BG_BYPASS
R/W-0000 000							R/W-0

Table 61. BG\_BYPASS Field Descriptions

Bit	Field	Type	Reset	Description
7-1	RESERVED	R/W	0000 000	RESERVED
0	BG_BYPASS	R/W	0	When set, VA11 is used as the voltage reference instead of the internal reference.

7.6.1.3.7 TMSTP± Control Register (address = 0x03B) [reset = 0x00]

Figure 101. TMSTP± Control Register (TMSTP\_CTRL)

7	6	5	4	3	2	1	0
RESERVED					TMSTP_LVPECL_EN	TMSTP_RECV_EN	
R/W-0000 00					R/W-0	R/W-0	

Table 62. TMSTP\_CTRL Field Descriptions

Bit	Field	Type	Reset	Description
7-2	RESERVED	R/W	0000 00	RESERVED
1	TMSTP_LVPECL_EN	R/W	0	When set, this bit activates the low-voltage PECL mode for the differential TMSTP± input.
0	TMSTP_RECV_EN	R/W	0	This bit enables the differential TMSTP± input.

**7.6.1.4 Serializer Registers (0x048 to 0x05F)**
**Table 63. Serializer Registers**

ADDRESS	RESET	ACRONYM	REGISTER NAME	SECTION
0x048	0x00	SER_PE	Serializer Pre-Emphasis Control Register	Serializer Pre-Emphasis Control Register (address = 0x048) [reset = 0x00]
0x049-0x05F	Undefined	RESERVED	RESERVED	—

**7.6.1.4.1 Serializer Pre-Emphasis Control Register (address = 0x048) [reset = 0x00]**
**Figure 102. Serializer Pre-Emphasis Control Register (SER\_PE)**

7	6	5	4	3	2	1	0
RESERVED				SER_PE			
R/W-0000				R/W-0000			

**Table 64. SER\_PE Field Descriptions**

Bit	Field	Type	Reset	Description
7-4	RESERVED	R/W	0000	RESERVED
3-0	SER_PE	R/W	0000	This field sets the pre-emphasis for the serial lanes to compensate for the low-pass response of the PCB trace. This setting is a global setting that affects all 16 lanes.



**7.6.1.5 Calibration Registers (0x060 to 0x0FF)**
**Table 65. Calibration Registers**

ADDRESS	RESET	ACRONYM	REGISTER NAME	SECTION
0x060	0x01	INPUT_MUX	Input Mux Control Register	Input Mux Control Register (address = 0x060) [reset = 0x01]
0x061	0x01	CAL_EN	Calibration Enable Register	Calibration Enable Register (address = 0x061) [reset = 0x01]
0x062	0x01	CAL_CFG0	Calibration Configuration 0 Register	Calibration Configuration 0 Register (address = 0x062) [reset = 0x01]
0x063-0x069	Undefined	RESERVED	RESERVED	—
0x06A	Undefined	CAL_STATUS	Calibration Status Register	Calibration Status Register (address = 0x06A) [reset = Undefined]
0x06B	0x00	CAL_PIN_CFG	Calibration Pin Configuration Register	Calibration Pin Configuration Register (address = 0x06B) [reset = 0x00]
0x06C	0x01	CAL_SOFT_TRIG	Calibration Software Trigger Register	Calibration Software Trigger Register (address = 0x06C) [reset = 0x01]
0x06D	Undefined	RESERVED	RESERVED	—
0x06E	0x88	CAL_LP	Low-Power Background Calibration Register	Low-Power Background Calibration Register (address = 0x06E) [reset = 0x88]
0x06F	Undefined	RESERVED	RESERVED	—
0x070	0x00	CAL_DATA_EN	Calibration Data Enable Register	Calibration Data Enable Register (address = 0x070) [reset = 0x00]
0x071	Undefined	CAL_DATA	Calibration Data Register	Calibration Data Register (address = 0x071) [reset = Undefined]
0x072-0x079	Undefined	RESERVED	RESERVED	—
0x07A	Undefined	GAIN_TRIM_A	Channel A Gain Trim Register	Channel A Gain Trim Register (address = 0x07A) [reset = Undefined]
0x07B	Undefined	GAIN_TRIM_B	Channel B Gain Trim Register	Channel B Gain Trim Register (address = 0x07B) [reset = Undefined]
0x07C	Undefined	BG_TRIM	Band-Gap Reference Trim Register	Band-Gap Reference Trim Register (address = 0x07C) [reset = Undefined]
0x07D	Undefined	RESERVED	RESERVED	—
0x07E	Undefined	RTRIM_A	VINA Input Resistor Trim Register	VINA Input Resistor Trim Register (address = 0x07E) [reset = Undefined]
0x07F	Undefined	RTRIM_B	VINB Input Resistor Trim Register	VINB Input Resistor Trim Register (address = 0x07F) [reset = Undefined]
0x080	Undefined	TADJ_A_FG90	Timing Adjustment for A-ADC, Single-Channel Mode, Foreground Calibration Register	Timing Adjust for A-ADC, Single-Channel Mode, Foreground Calibration Register (address = 0x080) [reset = Undefined]
0x081	Undefined	TADJ_B_FG0	Timing Adjustment for B-ADC, Single-Channel Mode, Foreground Calibration Register	Timing Adjust for B-ADC, Single-Channel Mode, Foreground Calibration Register (address = 0x081) [reset = Undefined]
0x082	Undefined	TADJ_A_BG90	Timing Adjustment for A-ADC, Single-Channel Mode, Background Calibration Register	Timing Adjust for A-ADC, Single-Channel Mode, Background Calibration Register (address = 0x082) [reset = Undefined]
0x083	Undefined	TADJ_C_BG0	Timing Adjustment for C-ADC, Single-Channel Mode, Background Calibration Register	Timing Adjust for C-ADC, Single-Channel Mode, Background Calibration Register (address = 0x084) [reset = Undefined]
0x084	Undefined	TADJ_C_BG90	Timing Adjustment for C-ADC, Single-Channel Mode, Background Calibration Register	Timing Adjust for C-ADC, Single-Channel Mode, Background Calibration Register (address = 0x084) [reset = Undefined]
0x085	Undefined	TADJ_B_BG0	Timing Adjustment for B-ADC, Single-Channel Mode, Background Calibration Register	Timing Adjust for B-ADC, Single-Channel Mode, Background Calibration Register (address = 0x085) [reset = Undefined]
0x086	Undefined	TADJ_A	Timing Adjustment for A-ADC, Dual-Channel Mode Register	Timing Adjust for A-ADC, Dual-Channel Mode Register (address = 0x086) [reset = Undefined]
0x087	Undefined	TADJ_CA	Timing Adjustment for C-ADC Acting for A-ADC, Dual-Channel Mode Register	Timing Adjust for C-ADC Acting for A-ADC, Dual-Channel Mode Register (address = 0x087) [reset = Undefined]
0x088	Undefined	TADJ_CB	Timing Adjustment for C-ADC Acting for B-ADC, Dual-Channel Mode Register	Timing Adjust for C-ADC Acting for B-ADC, Dual-Channel Mode Register (address = 0x088) [reset = Undefined]

**Table 65. Calibration Registers (continued)**

ADDRESS	RESET	ACRONYM	REGISTER NAME	SECTION
0x089	Undefined	TADJ_B	Timing Adjustment for B-ADC, Dual-Channel Mode Register	Timing Adjust for B-ADC, Dual-Channel Mode Register (address = 0x089) [reset = Undefined]
0x08A-0x08B	Undefined	OADJ_A_INA	Offset Adjustment for A-ADC and INA Register	Offset Adjustment for A-ADC and INA Register (address = 0x08A-0x08B) [reset = Undefined]
0x08C-0x08D	Undefined	OADJ_A_INB	Offset Adjustment for A-ADC and INB Register	Offset Adjustment for A-ADC and INB Register (address = 0x08C-0x08D) [reset = Undefined]
0x08E-0x08F	Undefined	OADJ_C_INA	Offset Adjustment for C-ADC and INA Register	Offset Adjustment for C-ADC and INA Register (address = 0x08E-0x08F) [reset = Undefined]
0x090-0x091	Undefined	OADJ_C_INB	Offset Adjustment for C-ADC and INB Register	Offset Adjustment for C-ADC and INB Register (address = 0x090-0x091) [reset = Undefined]
0x092-0x093	Undefined	OADJ_B_INA	Offset Adjustment for B-ADC and INA Register	Offset Adjustment for B-ADC and INA Register (address = 0x092-0x093) [reset = Undefined]
0x094-0x095	Undefined	OADJ_B_INB	Offset Adjustment for B-ADC and INB Register	Offset Adjustment for B-ADC and INB Register (address = 0x094-0x095) [reset = Undefined]
0x096	Undefined	RESERVED	RESERVED	—
0x097	0x00	OSFILT0	Offset Filtering Control 0	Offset Filtering Control 0 Register (address = 0x097) [reset = 0x00]
0x098	0x33	OSFILT1	Offset Filtering Control 1	Offset Filtering Control 1 Register (address = 0x098) [reset = 0x33]
0x099-0x0FF	Undefined	RESERVED	RESERVED	—

**7.6.1.5.1 Input Mux Control Register (address = 0x060) [reset = 0x01]**
**Figure 103. Input Mux Control Register (INPUT\_MUX)**

7	6	5	4	3	2	1	0
RESERVED			DUAL_INPUT	RESERVED		SINGLE_INPUT	
R/W-000			R/W-0	R/W-00		R/W-01	

**Table 66. INPUT\_MUX Field Descriptions**

Bit	Field	Type	Reset	Description
7-5	RESERVED	R/W	000	RESERVED
4	DUAL_INPUT	R/W	0	This bit selects inputs for dual-channel modes. If JMODE is selecting a single-channel mode, this register has no effect. 0: A channel samples INA, B channel samples INB (no swap, default) 1: A channel samples INB, B channel samples INA (swap)
3-2	RESERVED	R/W	00	RESERVED
1-0	SINGLE_INPUT	R/W	01	This field defines which input is sampled in single-channel mode. If JMODE is not selecting a single-channel mode, this register has no effect. 0: Reserved 1: INA is used (default) 2: INB is used 3: Reserved

**7.6.1.5.2 Calibration Enable Register (address = 0x061) [reset = 0x01]**
**Figure 104. Calibration Enable Register (CAL\_EN)**

7	6	5	4	3	2	1	0
RESERVED							CAL_EN
R/W-0000 000							R/W-1

**Table 67. CAL\_EN Field Descriptions**

Bit	Field	Type	Reset	Description
7-1	RESERVED	R/W	0000 000	RESERVED
0	CAL_EN	R/W	1	Calibration enable. Set this bit high to run calibration. Set this bit low to hold the calibration in reset to program new calibration settings. Clearing CAL_EN also resets the clock dividers that clock the digital block and JESD204B interface. Some calibration registers require clearing CAL_EN before making any changes. All registers with this requirement contain a note in their descriptions. After changing the registers, set CAL_EN to re-run calibration with the new settings. Always set CAL_EN before setting JESD_EN. Always clear JESD_EN before clearing CAL_EN.

**7.6.1.5.3 Calibration Configuration 0 Register (address = 0x062) [reset = 0x01]**

Only change this register when CAL\_EN is 0.

**Figure 105. Calibration Configuration 0 Register (CAL\_CFG0)**

7	6	5	4	3	2	1	0
RESERVED			CAL_OSFILT	CAL_BGOS	CAL_OS	CAL_BG	CAL_FG
R/W-000			R/W-0	R/W-0	R/W-0	R/W-0	R/W-1

**Table 68. CAL\_CFG0 Field Descriptions**

Bit	Field	Type	Reset	Description
7-5	RESERVED	R/W	0000	RESERVED
4	CAL_OSFILT	R/W	0	Enable offset filtering by setting this bit high.
3	CAL_BGOS	R/W	0	0 : Disables background offset calibration (default) 1: Enables background offset calibration (requires CAL_BG to be set).
2	CAL_OS	R/W	0	0 : Disables foreground offset calibration (default) 1: Enables foreground offset calibration (requires CAL_FG to be set)
1	CAL_BG	R/W	0	0 : Disables background calibration (default) 1: Enables background calibration
0	CAL_FG	R/W	1	0 : Resets calibration values, skips foreground calibration 1: Resets calibration values, then runs foreground calibration (default)

**7.6.1.5.4 Calibration Status Register (address = 0x06A) [reset = Undefined]**
**Figure 106. Calibration Status Register (CAL\_STATUS)**

7	6	5	4	3	2	1	0
RESERVED					CAL_STOPPED		FG_DONE
R					R		R

**Table 69. CAL\_STATUS Field Descriptions**

Bit	Field	Type	Reset	Description
7-2	RESERVED	R		RESERVED
1	CAL_STOPPED	R		This bit returns a 1 when the background calibration has successfully stopped at the requested phase. This bit returns a 0 when calibration starts operating again. If background calibration is disabled, this bit is set when foreground calibration is completed or skipped.
0	FG_DONE	R		This bit is set high when the foreground calibration completes.

**7.6.1.5.5 Calibration Pin Configuration Register (address = 0x06B) [reset = 0x00]**
**Figure 107. Calibration Pin Configuration Register (CAL\_PIN\_CFG)**

7	6	5	4	3	2	1	0
RESERVED					CAL_STATUS_SEL		CAL_TRIG_EN
R/W-0000 0					R/W-00		R/W-0

**Table 70. CAL\_PIN\_CFG Field Descriptions**

Bit	Field	Type	Reset	Description
7-3	RESERVED	R/W	0000 0	RESERVED
2-1	CAL_STATUS_SEL	R/W	00	0: CALSTAT output pin matches FG_DONE 1: RESERVED 2: CALSTAT output pin matches ALARM 3: CALSTAT output pin is always low
0	CAL_TRIG_EN	R/W	0	Choose the hardware or software trigger source with this bit. 0: Use the CAL_SOFT_TRIG register for the calibration trigger; the CAL_TRIG input is disabled (ignored) 1: Use the CAL_TRIG input for the calibration trigger; the CAL_SOFT_TRIG register is ignored

**7.6.1.5.6 Calibration Software Trigger Register (address = 0x06C) [reset = 0x01]**
**Figure 108. Calibration Software Trigger Register (CAL\_SOFT\_TRIG)**

7	6	5	4	3	2	1	0
RESERVED						CAL_SOFT_TRIG	
R/W-0000 000						R/W-1	

**Table 71. CAL\_SOFT\_TRIG Field Descriptions**

Bit	Field	Type	Reset	Description
7-1	RESERVED	R/W	0000 000	RESERVED
0	CAL_SOFT_TRIG	R/W	1	CAL_SOFT_TRIG is a software bit to provide functionality of the CAL_TRIG input. Program CAL_TRIG_EN = 0 to use CAL_SOFT_TRIG for the calibration trigger. If no calibration trigger is needed, leave CAL_TRIG_EN = 0 and CAL_SOFT_TRIG = 1 (trigger is set high).

**7.6.1.5.7 Low-Power Background Calibration Register (address = 0x06E) [reset = 0x88]**
**Figure 109. Low-Power Background Calibration Register (CAL\_LP)**

7	6	5	4	3	2	1	0
LP_SLEEP_DLY		LP_WAKE_DLY		RESERVED	LP_TRIG	LP_EN	
R/W-010		R/W-01		R/W-0	R/W-0	R/W-0	

**Table 72. CAL\_LP Field Descriptions**

Bit	Field	Type	Reset	Description
7-5	LP_SLEEP_DLY	R/W	010	Adjust how long an ADC sleeps before waking up for calibration (only applies when LP_EN = 1 and LP_TRIG = 0). Values below 4 are not recommended because of limited overall power reduction benefits. 0: Sleep delay = $(2^3 + 1) \times 256 \times t_{DEVCLK}$ 1: Sleep delay = $(2^{15} + 1) \times 256 \times t_{DEVCLK}$ 2: Sleep delay = $(2^{18} + 1) \times 256 \times t_{DEVCLK}$ 3: Sleep delay = $(2^{21} + 1) \times 256 \times t_{DEVCLK}$ 4: Sleep delay = $(2^{24} + 1) \times 256 \times t_{DEVCLK}$ : default is approximately 1338 ms with a 3.2-GHz clock 5: Sleep delay = $(2^{27} + 1) \times 256 \times t_{DEVCLK}$ 6: Sleep delay = $(2^{30} + 1) \times 256 \times t_{DEVCLK}$ 7: Sleep delay = $(2^{33} + 1) \times 256 \times t_{DEVCLK}$
4-3	LP_WAKE_DLY	R/W	01	Adjust how much time is given up for settling before calibrating an ADC after wake-up (only applies when LP_EN = 1). Values lower than 1 are not recommended because there is insufficient time for the core to stabilize before calibration begins. 0: Wake Delay = $(2^3 + 1) \times 256 \times t_{DEVCLK}$ 1: Wake Delay = $(2^{18} + 1) \times 256 \times t_{DEVCLK}$ : default is approximately 21 ms with a 3.2-GHz clock 2: Wake Delay = $(2^{21} + 1) \times 256 \times t_{DEVCLK}$ 3: Wake Delay = $(2^{24} + 1) \times 256 \times t_{DEVCLK}$
2	RESERVED	R/W	0	RESERVED
1	LP_TRIG	R/W	0	0: ADC sleep duration is set by LP_SLEEP_DLY (autonomous mode) 1: ADCs sleep until woken by a trigger; an ADC is awoken when the calibration trigger (CAL_SOFT_TRIG bit or CAL_TRIG input) is low
0	LP_EN	R/W	0	0: Disables low-power background calibration (default) 1: Enables low-power background calibration (only applies when CAL_BG = 1)

**7.6.1.5.8 Calibration Data Enable Register (address = 0x070) [reset = 0x00]**
**Figure 110. Calibration Data Enable Register (CAL\_DATA\_EN)**

7	6	5	4	3	2	1	0
RESERVED						CAL_DATA_EN	
R/W-0000 000						R/W-0	

**Table 73. CAL\_DATA\_EN Field Descriptions**

Bit	Field	Type	Reset	Description
7-1	RESERVED	R/W	0000 000	RESERVED
0	CAL_DATA_EN	R/W	0	Set this bit to enable the CAL_DATA register to enable reading and writing of calibration data; see the <a href="#">calibration data register</a> for more information.

**7.6.1.5.9 Calibration Data Register (address = 0x071) [reset = Undefined]**
**Figure 111. Calibration Data Register (CAL\_DATA)**

7	6	5	4	3	2	1	0
CAL_DATA							
R/W							

**Table 74. CAL\_DATA Field Descriptions**

Bit	Field	Type	Reset	Description
7-0	CAL_DATA	R/W	Undefined	<p>After setting CAL_DATA_EN, repeated reads of this register return all calibration values for the ADCs. Repeated writes of this register input all calibration values for the ADCs. To read the calibration data, read the register 673 times. To write the vector, write the register 673 times with previously stored calibration data.</p> <p>To speed up the read/write operation, set ADDR_HOLD = 1 and use the streaming read or write process.</p> <p>Accessing the CAL_DATA register when CAL_STOPPED = 0 corrupts the calibration. Also, stopping the process before reading or writing 673 times leaves the calibration data in an invalid state.</p>

**7.6.1.5.10 Channel A Gain Trim Register (address = 0x07A) [reset = Undefined]**
**Figure 112. Channel A Gain Trim Register (GAIN\_TRIM\_A)**

7	6	5	4	3	2	1	0
GAIN_TRIM_A							
R/W							

**Table 75. GAIN\_TRIM\_A Field Descriptions**

Bit	Field	Type	Reset	Description
7-0	GAIN_TRIM_A	R/W	Undefined	This register enables gain trim of channel A. After reset, the factory-trimmed value can be read and adjusted as required.

**7.6.1.5.11 Channel B Gain Trim Register (address = 0x07B) [reset = Undefined]**
**Figure 113. Channel B Gain Trim Register (GAIN\_TRIM\_B)**

7	6	5	4	3	2	1	0
GAIN_TRIM_B							
R/W							

**Table 76. GAIN\_TRIM\_B Field Descriptions**

Bit	Field	Type	Reset	Description
7-0	GAIN_TRIM_B	R/W	Undefined	This register enables gain trim of channel B. After reset, the factory-trimmed value can be read and adjusted as required.

**7.6.1.5.12 Band-Gap Reference Trim Register (address = 0x07C) [reset = Undefined]**
**Figure 114. Band-Gap Reference Trim Register (BG\_TRIM)**

7	6	5	4	3	2	1	0
RESERVED				BG_TRIM			
R/W-0000				R/W			

**Table 77. BG\_TRIM Field Descriptions**

Bit	Field	Type	Reset	Description
7-4	RESERVED	R/W	0000	RESERVED
3-0	BG_TRIM	R/W	Undefined	This register enables the internal band-gap reference to be trimmed. After reset, the factory-trimmed value can be read and adjusted as required.

**7.6.1.5.13 VINA Input Resistor Trim Register (address = 0x07E) [reset = Undefined]**
**Figure 115. VINA Input Resistor Trim Register (RTRIM\_A)**

7	6	5	4	3	2	1	0
RTRIM							
R/W							

**Table 78. RTRIM\_A Field Descriptions**

Bit	Field	Type	Reset	Description
7-0	RTRIM_A	R/W	Undefined	This register controls the VINA ADC input termination trim. After reset, the factory-trimmed value can be read and adjusted as required.

**7.6.1.5.14 VINB Input Resistor Trim Register (address = 0x07F) [reset = Undefined]**
**Figure 116. VINB Input Resistor Trim Register (RTRIM\_B)**

7	6	5	4	3	2	1	0
RTRIM							
R/W							

**Table 79. RTRIM\_B Field Descriptions**

Bit	Field	Type	Reset	Description
7-0	RTRIM_B	R/W	Undefined	This register controls the VINB ADC input termination trim. After reset, the factory-trimmed value can be read and adjusted as required.

**7.6.1.5.15 Timing Adjust for A-ADC, Single-Channel Mode, Foreground Calibration Register (address = 0x080) [reset = Undefined]**
**Figure 117. Register (TADJ\_A\_FG90)**

7	6	5	4	3	2	1	0
TADJ_A_FG90							
R/W							

**Table 80. TADJ\_A\_FG90 Field Descriptions**

Bit	Field	Type	Reset	Description
7-0	TADJ_A_FG90	R/W	Undefined	This register (and other subsequent TADJ* registers) are used to adjust the sampling instant of each ADC core. Different TADJ registers apply to different ADCs under different modes or phases of background calibration. After reset, the factory-trimmed value can be read and adjusted as required.

**7.6.1.5.16 Timing Adjust for B-ADC, Single-Channel Mode, Foreground Calibration Register (address = 0x081) [reset = Undefined]**
**Figure 118. Register (TADJ\_B\_FG0)**

7	6	5	4	3	2	1	0
TADJ_B_FG0							
R/W							

**Table 81. TADJ\_B\_FG0 Field Descriptions**

Bit	Field	Type	Reset	Description
7-0	TADJ_B_FG0	R/W	Undefined	This register (and other subsequent TADJ* registers) are used to adjust the sampling instant of each ADC core. Different TADJ registers apply to different ADCs under different modes or phases of background calibration. After reset, the factory-trimmed value can be read and adjusted as required.

**7.6.1.5.17 Timing Adjust for A-ADC, Single-Channel Mode, Background Calibration Register (address = 0x082) [reset = Undefined]**
**Figure 119. Register (TADJ\_A\_BG90)**

7	6	5	4	3	2	1	0
TADJ_A_BG90							
R/W							

**Table 82. TADJ\_B\_FG0 Field Descriptions**

Bit	Field	Type	Reset	Description
7-0	TADJ_A_BG90	R/W	Undefined	This register (and other subsequent TADJ* registers) are used to adjust the sampling instant of each ADC core. Different TADJ registers apply to different ADCs under different modes or phases of background calibration. After reset, the factory-trimmed value can be read and adjusted as required.



**7.6.1.5.18 Timing Adjust for C-ADC, Single-Channel Mode, Background Calibration Register (address = 0x083)  
[reset = Undefined]**
**Figure 120. Timing Adjust for C-ADC, Single-Channel Mode, Background Calibration Register (TADJ\_C\_BG0)**

7	6	5	4	3	2	1	0
TADJ_C_BG0							
R/W							

**Table 83. TADJ\_B\_FG0 Field Descriptions**

Bit	Field	Type	Reset	Description
7-0	TADJ_C_BG0	R/W	Undefined	This register (and other subsequent TADJ* registers) are used to adjust the sampling instant of each ADC core. Different TADJ registers apply to different ADCs under different modes or phases of background calibration. After reset, the factory-trimmed value can be read and adjusted as required.

**7.6.1.5.19 Timing Adjust for C-ADC, Single-Channel Mode, Background Calibration Register (address = 0x084)  
[reset = Undefined]**
**Figure 121. Timing Adjust for C-ADC, Single-Channel Mode, Background Calibration Register (TADJ\_C\_BG90)**

7	6	5	4	3	2	1	0
TADJ_C_BG90							
R/W							

**Table 84. TADJ\_B\_FG0 Field Descriptions**

Bit	Field	Type	Reset	Description
7-0	TADJ_C_BG90	R/W	Undefined	This register (and other subsequent TADJ* registers) are used to adjust the sampling instant of each ADC core. Different TADJ registers apply to different ADCs under different modes or phases of background calibration. After reset, the factory-trimmed value can be read and adjusted as required.

**7.6.1.5.20 Timing Adjust for B-ADC, Single-Channel Mode, Background Calibration Register (address = 0x085)  
[reset = Undefined]**
**Figure 122. Timing Adjust for B-ADC, Single-Channel Mode, Background Calibration Register (TADJ\_B\_BG0)**

7	6	5	4	3	2	1	0
TADJ_B_BG0							
R/W							

**Table 85. TADJ\_B\_FG0 Field Descriptions**

Bit	Field	Type	Reset	Description
7-0	TADJ_B_BG0	R/W	Undefined	This register (and other subsequent TADJ* registers) are used to adjust the sampling instant of each ADC core. Different TADJ registers apply to different ADCs under different modes or phases of background calibration. After reset, the factory-trimmed value can be read and adjusted as required.

7.6.1.5.21 Timing Adjust for A-ADC, Dual-Channel Mode Register (address = 0x086) [reset = Undefined]

Figure 123. Timing Adjust for A-ADC, Dual-Channel Mode Register (TADJ\_A)

7	6	5	4	3	2	1	0
TADJ_A							
R/W							

Table 86. TADJ\_A Field Descriptions

Bit	Field	Type	Reset	Description
7-0	TADJ_A	R/W	Undefined	This register (and other subsequent TADJ* registers) are used to adjust the sampling instant of each ADC core. Different TADJ registers apply to different ADCs under different modes or phases of background calibration. After reset, the factory-trimmed value can be read and adjusted as required.

7.6.1.5.22 Timing Adjust for C-ADC Acting for A-ADC, Dual-Channel Mode Register (address = 0x087) [reset = Undefined]

Figure 124. Timing Adjust for C-ADC Acting for A-ADC, Dual-Channel Mode Register (TADJ\_CA)

7	6	5	4	3	2	1	0
TADJ_CA							
R/W							

Table 87. TADJ\_CA Field Descriptions

Bit	Field	Type	Reset	Description
7-0	TADJ_CA	R/W	Undefined	This register (and other subsequent TADJ* registers) are used to adjust the sampling instant of each ADC core. Different TADJ registers apply to different ADCs under different modes or phases of background calibration. After reset, the factory-trimmed value can be read and adjusted as required.

7.6.1.5.23 Timing Adjust for C-ADC Acting for B-ADC, Dual-Channel Mode Register (address = 0x088) [reset = Undefined]

Figure 125. Timing Adjust for C-ADC Acting for B-ADC, Dual-Channel Mode Register (TADJ\_CB)

7	6	5	4	3	2	1	0
TADJ_CB							
R/W							

Table 88. TADJ\_CB Field Descriptions

Bit	Field	Type	Reset	Description
7-0	TADJ_CB	R/W	Undefined	This register (and other subsequent TADJ* registers) are used to adjust the sampling instant of each ADC core. Different TADJ registers apply to different ADCs under different modes or phases of background calibration. After reset, the factory-trimmed value can be read and adjusted as required.

**7.6.1.5.24 Timing Adjust for B-ADC, Dual-Channel Mode Register (address = 0x089) [reset = Undefined]**
**Figure 126. Timing Adjust for B-ADC, Dual-Channel Mode Register (TADJ\_B)**

7	6	5	4	3	2	1	0
TADJ_B							
R/W							

**Table 89. TADJ\_B Field Descriptions**

Bit	Field	Type	Reset	Description
7-0	TADJ_B	R/W	Undefined	This register (and other subsequent TADJ* registers) are used to adjust the sampling instant of each ADC core. Different TADJ registers apply to different ADCs under different modes or phases of background calibration. After reset, the factory-trimmed value can be read and adjusted as required.

**7.6.1.5.25 Offset Adjustment for A-ADC and INA Register (address = 0x08A-0x08B) [reset = Undefined]**
**Figure 127. Offset Adjustment for A-ADC and INA Register (OADJ\_A\_INA)**

15	14	13	12	11	10	9	8
RESERVED				OADJ_A_INA[11:8]			
R/W-0000				R/W			
7	6	5	4	3	2	1	0
OADJ_A_INA[7:0]							
R/W							

**Table 90. OADJ\_A\_INA Field Descriptions**

Bit	Field	Type	Reset	Description
15-12	RESERVED	R/W	0000	RESERVED
11-0	OADJ_A_INA	R/W	Undefined	Offset adjustment value for ADC0 (A-ADC) applied when ADC0 samples INA. The format is unsigned. After reset, the factory-trimmed value can be read and adjusted as required. Important notes: <ul style="list-style-type: none"> <li>• Never write OADJ* registers while foreground calibration is underway</li> <li>• Never write OADJ* registers if CAL_BG and CAL_BGOS are set</li> <li>• If CAL_OS = 1 and CAL_BGOS = 0, only read OADJ* registers if FG_DONE = 1</li> <li>• If CAL_BG = 1 and CAL_BGOS = 1, only read OADJ* register if CAL_STOPPED = 1</li> </ul>

**7.6.1.5.26 Offset Adjustment for A-ADC and INB Register (address = 0x08C-0x08D) [reset = Undefined]**
**Figure 128. Offset Adjustment for A-ADC and INB Register (OAJ\_A\_INB)**

15	14	13	12	11	10	9	8
RESERVED				OAJ_A_INB[11:8]			
R/W-0000				R/W			
7	6	5	4	3	2	1	0
OAJ_A_INB[7:0]							
R/W							

**Table 91. OAJ\_A\_INB Field Descriptions**

Bit	Field	Type	Reset	Description
15-12	RESERVED	R/W	0000	RESERVED
11-0	OAJ_A_INB	R/W	Undefined	Offset adjustment value for ADC0 (A-ADC) applied when ADC0 samples INB. The format is unsigned. After reset, the factory-trimmed value can be read and adjusted as required. Important notes: <ul style="list-style-type: none"> <li>• Never write OAJ* registers while foreground calibration is underway</li> <li>• Never write OAJ* registers if CAL_BG and CAL_BGOS are set</li> <li>• If CAL_OS = 1 and CAL_BGOS = 0, only read OAJ* registers if FG_DONE = 1</li> <li>• If CAL_BG = 1 and CAL_BGOS = 1, only read OAJ* register if CAL_STOPPED = 1</li> </ul>

**7.6.1.5.27 Offset Adjustment for C-ADC and INA Register (address = 0x08E-0x08F) [reset = Undefined]**
**Figure 129. Offset Adjustment for C-ADC and INA Register (OAJ\_C\_INA)**

15	14	13	12	11	10	9	8
RESERVED				OAJ_C_INA[11:8]			
R/W-0000				R/W			
7	6	5	4	3	2	1	0
OAJ_C_INA[7:0]							
R/W							

**Table 92. OAJ\_C\_INA Field Descriptions**

Bit	Field	Type	Reset	Description
15-12	RESERVED	R/W	0000	RESERVED
11-0	OAJ_C_INA	R/W	Undefined	Offset adjustment value for ADC1 (A-ADC) applied when ADC1 samples INA. The format is unsigned. After reset, the factory-trimmed value can be read and adjusted as required. Important notes: <ul style="list-style-type: none"> <li>• Never write OAJ* registers while foreground calibration is underway</li> <li>• Never write OAJ* registers if CAL_BG and CAL_BGOS are set</li> <li>• If CAL_OS = 1 and CAL_BGOS = 0, only read OAJ* registers if FG_DONE = 1</li> <li>• If CAL_BG = 1 and CAL_BGOS = 1, only read OAJ* register if CAL_STOPPED = 1</li> </ul>

**7.6.1.5.28 Offset Adjustment for C-ADC and INB Register (address = 0x090-0x091) [reset = Undefined]**
**Figure 130. Offset Adjustment for C-ADC and INB Register (OADJ\_C\_INB)**

15	14	13	12	11	10	9	8
RESERVED				OADJ_C_INB[11:8]			
R/W-0000				R/W			
7	6	5	4	3	2	1	0
OADJ_C_INB[7:0]							
R/W							

**Table 93. OADJ\_C\_INB Field Descriptions**

Bit	Field	Type	Reset	Description
15-12	RESERVED	R/W	0000	RESERVED
11-0	OADJ_C_INB	R/W	Undefined	Offset adjustment value for ADC1 (A-ADC) applied when ADC1 samples INB. The format is unsigned. After reset, the factory-trimmed value can be read and adjusted as required. Important notes: <ul style="list-style-type: none"> <li>• Never write OADJ* registers while foreground calibration is underway</li> <li>• Never write OADJ* registers if CAL_BG and CAL_BGOS are set</li> <li>• If CAL_OS = 1 and CAL_BGOS = 0, only read OADJ* registers if FG_DONE = 1</li> <li>• If CAL_BG = 1 and CAL_BGOS = 1, only read OADJ* register if CAL_STOPPED = 1</li> </ul>

**7.6.1.5.29 Offset Adjustment for B-ADC and INA Register (address = 0x092-0x093) [reset = Undefined]**
**Figure 131. Offset Adjustment for B-ADC and INA Register (OADJ\_B\_INA)**

15	14	13	12	11	10	9	8
RESERVED				OADJ_B_INA[11:8]			
R/W-0000				R/W			
7	6	5	4	3	2	1	0
OADJ_B_INA[7:0]							
R/W							

**Table 94. OADJ\_B\_INA Field Descriptions**

Bit	Field	Type	Reset	Description
15-12	RESERVED	R/W	0000	RESERVED
11-0	OADJ_B_INA	R/W	Undefined	Offset adjustment value for ADC2 (B-ADC) applied when ADC2 samples INA. The format is unsigned. After reset, the factory-trimmed value can be read and adjusted as required. Important notes: <ul style="list-style-type: none"> <li>• Never write OADJ* registers while foreground calibration is underway</li> <li>• Never write OADJ* registers if CAL_BG and CAL_BGOS are set</li> <li>• If CAL_OS = 1 and CAL_BGOS = 0, only read OADJ* registers if FG_DONE = 1</li> <li>• If CAL_BG = 1 and CAL_BGOS = 1, only read OADJ* register if CAL_STOPPED = 1</li> </ul>

**7.6.1.5.30 Offset Adjustment for B-ADC and INB Register (address = 0x094-0x095) [reset = Undefined]**
**Figure 132. Offset Adjustment for B-ADC and INB Register (OADJ\_B\_INB)**

15	14	13	12	11	10	9	8
RESERVED				OADJ_B_INB[11:8]			
R/W-0000				R/W			
7	6	5	4	3	2	1	0
OADJ_B_INB[7:0]							
R/W							

**Table 95. OADJ\_B\_INB Field Descriptions**

Bit	Field	Type	Reset	Description
15-12	RESERVED	R/W	0000	RESERVED
11-0	OADJ_B_INB	R/W	Undefined	Offset adjustment value for ADC2 (B-ADC) applied when ADC2 samples INB. The format is unsigned. After reset, the factory-trimmed value can be read and adjusted as required. Important notes: <ul style="list-style-type: none"> <li>• Never write OADJ* registers while foreground calibration is underway</li> <li>• Never write OADJ* registers if CAL_BG and CAL_BGOS are set</li> <li>• If CAL_OS = 1 and CAL_BGOS=0, only read OADJ* registers if FG_DONE = 1</li> <li>• If CAL_BG = 1 and CAL_BGOS=1, only read OADJ* register if CAL_STOPPED = 1</li> </ul>

**7.6.1.5.31 Offset Filtering Control 0 Register (address = 0x097) [reset = 0x00]**
**Figure 133. Offset Filtering Control 0 Register (OSFILTO)**

7	6	5	4	3	2	1	0
RESERVED						DC_RESTORE	
R/W-0000 000						R/W	

**Table 96. OSFILTO Field Descriptions**

Bit	Field	Type	Reset	Description
7-1	RESERVED	R/W	0000 000	RESERVED
0	DC_RESTORE	R/W	0	When set, the offset filtering feature (enabled by CAL_OSFILT) filters only the offset mismatch across ADC banks and does not remove the frequency content near DC. When cleared, the feature filters all offsets from all banks, thus filtering all DC content in the signal; see the <a href="#">Offset Filtering</a> section.

**7.6.1.5.32 Offset Filtering Control 1 Register (address = 0x098) [reset = 0x33]**
**Figure 134. Offset Filtering Control 1 Register (OSFILT1)**

7	6	5	4	3	2	1	0
OSFILT_BW				OSFILT_SOAK			
R/W-0011				R/W-0011			

**Table 97. OSFILT1 Field Descriptions**

Bit	Field	Type	Reset	Description
7-4	OSFILT_BW	R/W	0011	<p>This field adjusts the IIR filter bandwidth for the offset filtering feature (enabled by CAL_OSFILT). More bandwidth suppresses more flicker noise from the ADCs and reduces the offset spurs. Less bandwidth minimizes the impact of the filters on the mission mode signal.</p> <p>OSFILT_BW: IIR coefficient: –3-dB bandwidth (single sided)</p> <p>0: Reserved            1: <math>2^{-10}</math> : <math>609e-9 \times F_{DEVCLK}</math>            2: <math>2^{-11}</math> : <math>305e-9 \times F_{DEVCLK}</math>            3: <math>2^{-12}</math> : <math>152e-9 \times F_{DEVCLK}</math>            4: <math>2^{-13}</math> : <math>76e-9 \times F_{DEVCLK}</math>            5: <math>2^{-14}</math> : <math>38e-9 \times F_{DEVCLK}</math>            6-15: Reserved</p>
3-0	OSFILT_SOAK	R/W	0011	<p>This field adjusts the IIR soak time for the offset filtering feature. This field applies when offset filtering and background calibration are both enabled. This field determines how long the IIR filter is allowed to settle when first connected to an ADC after the ADC is calibrated. After the soak time completes, the ADC is placed online using the IIR filter. Set OSFILT_SOAK = OSFILT_BW.</p>

**7.6.1.6 ADC Bank Registers (0x100 to 0x15F)**

**Table 98. ADC Bank Registers**

ADDRESS	RESET	ACRONYM	REGISTER NAME	SECTION
0x100-0x101	Undefined	RESERVED	RESERVED	—
0x102	Undefined	B0_TIME_0	Timing Adjustment for Bank 0 (0° Clock) Register	Timing Adjustment for Bank 0 (0° Clock) Register (address = 0x102) [reset = Undefined]
0x103	Undefined	B0_TIME_90	Timing Adjustment for Bank 0 (–90° Clock) Register	Timing Adjustment for Bank 0 (–90° Clock) Register (address = 0x103) [reset = Undefined]
0x104-0x111	Undefined	RESERVED	RESERVED	—
0x112	Undefined	B1_TIME_0	Timing Adjustment for Bank 1 (0° Clock) Register	Timing Adjustment for Bank 1 (0° Clock) Register (address = 0x112) [reset = Undefined]
0x113	Undefined	B1_TIME_90	Timing Adjustment for Bank 1 (–90° Clock) Register	Timing Adjustment for Bank 1 (–90° Clock) Register (address = 0x113) [reset = Undefined]
0x114-0x121	Undefined	RESERVED	RESERVED	—
0x122	Undefined	B2_TIME_0	Timing Adjustment for Bank 2 (0° Clock) Register	Timing Adjustment for Bank 2 (0° Clock) Register (address = 0x122) [reset = Undefined]
0x123	Undefined	B2_TIME_90	Timing Adjustment for Bank 2 (–90° Clock) Register	Timing Adjustment for Bank 2 (–90° Clock) Register (address = 0x123) [reset = Undefined]
0x124-0x131	Undefined	RESERVED	RESERVED	—
0x132	Undefined	B3_TIME_0	Timing Adjustment for Bank 3 (0° Clock) Register	Timing Adjustment for Bank 3 (0° Clock) Register (address = 0x132) [reset = Undefined]
0x133	Undefined	B3_TIME_90	Timing Adjustment for Bank 3 (–90° Clock) Register	Timing Adjustment for Bank 3 (–90° Clock) Register (address = 0x133) [reset = Undefined]
0x134-0x141	Undefined	RESERVED	RESERVED	—
0x142	Undefined	B4_TIME_0	Timing Adjustment for Bank 4 (0° Clock) Register	Timing Adjustment for Bank 4 (0° Clock) Register (address = 0x142) [reset = Undefined]
0x143	Undefined	B4_TIME_90	Timing Adjustment for Bank 4 (–90° Clock) Register	Timing Adjustment for Bank 4 (–90° Clock) Register (address = 0x143) [reset = Undefined]
0x144-0x151	Undefined	RESERVED	RESERVED	—
0x152	Undefined	B5_TIME_0	Timing Adjustment for Bank 5 (0° Clock) Register	Timing Adjustment for Bank 5 (0° Clock) Register (address = 0x152) [reset = Undefined]
0x153	Undefined	B5_TIME_90	Timing Adjustment for Bank 5 (–90° Clock) Register	Timing Adjustment for Bank 5 (–90° Clock) Register (address = 0x153) [reset = Undefined]
0x154-0x15F	Undefined	RESERVED	RESERVED	—

**7.6.1.6.1 Timing Adjustment for Bank 0 (0° Clock) Register (address = 0x102) [reset = Undefined]**

**Figure 135. Timing Adjustment for Bank 0 (0° Clock) Register (B0\_TIME\_0)**

7	6	5	4	3	2	1	0
B0_TIME_0							
R/W							

**Table 99. B0\_TIME\_0 Field Descriptions**

Bit	Field	Type	Reset	Description
7-0	B0_TIME_0	R/W	Undefined	Time adjustment for bank 0 (applied when the ADC is configured for 0° clock phase). After reset, the factory-trimmed value can be read and adjusted as required.



**7.6.1.6.2 Timing Adjustment for Bank 0 (–90° Clock) Register (address = 0x103) [reset = Undefined]**
**Figure 136. Timing Adjustment for Bank 0 (–90° Clock) Register (B0\_TIME\_90)**

7	6	5	4	3	2	1	0
B0_TIME_90							
R/W							

**Table 100. B0\_TIME\_90 Field Descriptions**

Bit	Field	Type	Reset	Description
7-0	B0_TIME_90	R/W	Undefined	Time adjustment for bank 0 (applied when the ADC is configured for –90° clock phase). After reset, the factory-trimmed value can be read and adjusted as required.

**7.6.1.6.3 Timing Adjustment for Bank 1 (0° Clock) Register (address = 0x112) [reset = Undefined]**
**Figure 137. Timing Adjustment for Bank 1 (0° Clock) Register (B1\_TIME\_0)**

7	6	5	4	3	2	1	0
B1_TIME_0							
R/W							

**Table 101. B1\_TIME\_0 Field Descriptions**

Bit	Field	Type	Reset	Description
7-0	B1_TIME_0	R/W	Undefined	Time adjustment for bank 1 (applied when the ADC is configured for 0° clock phase). After reset, the factory-trimmed value can be read and adjusted as required.

**7.6.1.6.4 Timing Adjustment for Bank 1 (–90° Clock) Register (address = 0x113) [reset = Undefined]**
**Figure 138. Timing Adjustment for Bank 1 (–90° Clock) Register (B1\_TIME\_90)**

7	6	5	4	3	2	1	0
B1_TIME_90							
R/W							

**Table 102. B1\_TIME\_90 Field Descriptions**

Bit	Field	Type	Reset	Description
7-0	B1_TIME_90	R/W	Undefined	Time adjustment for bank 1 (applied when the ADC is configured for –90° clock phase). After reset, the factory-trimmed value can be read and adjusted as required.

**7.6.1.6.5 Timing Adjustment for Bank 2 (0° Clock) Register (address = 0x122) [reset = Undefined]**
**Figure 139. Timing Adjustment for Bank 2 (0° Clock) Register (B2\_TIME\_0)**

7	6	5	4	3	2	1	0
B2_TIME_0							
R/W							

**Table 103. B2\_TIME\_0 Field Descriptions**

Bit	Field	Type	Reset	Description
7-0	B2_TIME_0	R/W	Undefined	Time adjustment for bank 2 (applied when the ADC is configured for 0° clock phase). After reset, the factory-trimmed value can be read and adjusted as required.

7.6.1.6.6 Timing Adjustment for Bank 2 (–90° Clock) Register (address = 0x123) [reset = Undefined]

Figure 140. Timing Adjustment for Bank 2 (–90° Clock) Register (B2\_TIME\_90)

7	6	5	4	3	2	1	0
B2_TIME_90							
R/W							

Table 104. B2\_TIME\_90 Field Descriptions

Bit	Field	Type	Reset	Description
7-0	B2_TIME_90	R/W	Undefined	Time adjustment for bank 2 (applied when the ADC is configured for –90° clock phase). After reset, the factory-trimmed value can be read and adjusted as required.

7.6.1.6.7 Timing Adjustment for Bank 3 (0° Clock) Register (address = 0x132) [reset = Undefined]

Figure 141. Timing Adjustment for Bank 3 (0° Clock) Register (B3\_TIME\_0)

7	6	5	4	3	2	1	0
B3_TIME_0							
R/W							

Table 105. B3\_TIME\_0 Field Descriptions

Bit	Field	Type	Reset	Description
7-0	B3_TIME_0	R/W	Undefined	Time adjustment for bank 3 (applied when the ADC is configured for 0° clock phase). After reset, the factory-trimmed value can be read and adjusted as required.

7.6.1.6.8 Timing Adjustment for Bank 3 (–90° Clock) Register (address = 0x133) [reset = Undefined]

Figure 142. Timing Adjustment for Bank 3 (–90° Clock) Register (B3\_TIME\_90)

7	6	5	4	3	2	1	0
B3_TIME_90							
R/W							

Table 106. B3\_TIME\_90 Field Descriptions

Bit	Field	Type	Reset	Description
7-0	B3_TIME_90	R/W	Undefined	Time adjustment for bank 3 (applied when the ADC is configured for –90° clock phase). After reset, the factory-trimmed value can be read and adjusted as required.

7.6.1.6.9 Timing Adjustment for Bank 4 (0° Clock) Register (address = 0x142) [reset = Undefined]

Figure 143. Timing Adjustment for Bank 4 (0° Clock) Register (B4\_TIME\_0)

7	6	5	4	3	2	1	0
B4_TIME_0							
R/W							

Table 107. B4\_TIME\_0 Field Descriptions

Bit	Field	Type	Reset	Description
7-0	B4_TIME_0	R/W	Undefined	Time adjustment for bank 4 (applied when the ADC is configured for 0° clock phase). After reset, the factory-trimmed value can be read and adjusted as required.

**7.6.1.6.10 Timing Adjustment for Bank 4 (–90° Clock) Register (address = 0x143) [reset = Undefined]**
**Figure 144. Timing Adjustment for Bank 4 (–90° Clock) Register (B4\_TIME\_90)**

7	6	5	4	3	2	1	0
B4_TIME_90							
R/W							

**Table 108. B4\_TIME\_90 Field Descriptions**

Bit	Field	Type	Reset	Description
7-0	B4_TIME_90	R/W	Undefined	Time adjustment for bank 4 (applied when the ADC is configured for –90° clock phase). After reset, the factory-trimmed value can be read and adjusted as required.

**7.6.1.6.11 Timing Adjustment for Bank 5 (0° Clock) Register (address = 0x152) [reset = Undefined]**
**Figure 145. Timing Adjustment for Bank 5 (0° Clock) Register (B5\_TIME\_0)**

7	6	5	4	3	2	1	0
B5_TIME_0							
R/W							

**Table 109. B5\_TIME\_0 Field Descriptions**

Bit	Field	Type	Reset	Description
7-0	B5_TIME_0	R/W	Undefined	Time adjustment for bank 5 (applied when the ADC is configured for 0° clock phase). After reset, the factory-trimmed value can be read and adjusted as required.

**7.6.1.6.12 Timing Adjustment for Bank 5 (–90° Clock) Register (address = 0x153) [reset = Undefined]**
**Figure 146. Timing Adjustment for Bank 5 (–90° Clock) Register (B5\_TIME\_90)**

7	6	5	4	3	2	1	0
B5_TIME_90							
R/W							

**Table 110. B5\_TIME\_90 Field Descriptions**

Bit	Field	Type	Reset	Description
7-0	B5_TIME_90	R/W	Undefined	Time adjustment for bank 5 (applied when the ADC is configured for –90° clock phase). After reset, the factory-trimmed value can be read and adjusted as required.

**7.6.1.7 LSB Control Registers (0x160 to 0x1FF)**
**Table 111. LSB Control Registers**

ADDRESS	RESET	ACRONYM	REGISTER NAME	SECTION
0x160	0x00	ENC_LSB	LSB Control Bit Output Register	LSB Control Bit Output Register (address = 0x160) [reset = 0x00]
0x161-0x1FF	Undefined	RESERVED	RESERVED	—

**7.6.1.7.1 LSB Control Bit Output Register (address = 0x160) [reset = 0x00]**
**Figure 147. LSB Control Bit Output Register (ENC\_LSB)**

7	6	5	4	3	2	1	0
RESERVED							TIMESTAMP_EN
R/W-0000 000							R/W-0

**Table 112. ENC\_LSB Field Descriptions**

Bit	Field	Type	Reset	Description
7-1	RESERVED	R/W	0000 000	RESERVED
0	TIMESTAMP_EN	R/W	0	When set, the transport layer transmits the timestamp signal on the LSB of the output samples. Only supported in decimate-by-1 (DDC bypass) modes. TIMESTAMP_EN has priority over CAL_STATE_EN. TMSTP_RECV_EN must also be set high when using timestamp. The latency of the timestamp signal (through the entire device) matches the latency of the analog ADC inputs. In 8-bit modes, the control bit is placed on the LSB of the 8-bit samples (leaving 7 bits of sample data). If the device is configured for 12-bit data, the control bit is placed on the LSB of the 12-bit data (leaving 11 bits of sample data). The control bit enabled by this register is never advertised in the ILA (the CS field is 0 in the ILA).

7.6.1.8 JESD204B Registers (0x200 to 0x20F)

Table 113. JESD204B Registers

ADDRESS	RESET	ACRONYM	REGISTER NAME	SECTION
0x200	0x01	JESD_EN	JESD204B Enable Register	JESD204B Enable Register (address = 0x200) [reset = 0x01]
0x201	0x02	JMODE	JESD204B Mode Register	JESD204B Mode Register (address = 0x201) [reset = 0x02]
0x202	0x1F	KM1	JESD204B K Parameter Register	JESD204B K Parameter Register (address = 0x202) [reset = 0x1F]
0x203	0x01	JSYNC_N	JESD204B Manual SYNC Request Register	JESD204B Manual SYNC Request Register (address = 0x203) [reset = 0x01]
0x204	0x02	JCTRL	JESD204B Control Register	JESD204B Control Register (address = 0x204) [reset = 0x02]
0x205	0x00	JTEST	JESD204B Test Pattern Control Register	JESD204B Test Pattern Control Register (address = 0x205) [reset = 0x00]
0x206	0x00	DID	JESD204B DID Parameter Register	JESD204B DID Parameter Register (address = 0x206) [reset = 0x00]
0x207	0x00	FCHAR	JESD204B Frame Character Register	JESD204B Frame Character Register (address = 0x207) [reset = 0x00]
0x208	Undefined	JESD_STATUS	JESD204B, System Status Register	JESD204B, System Status Register (address = 0x208) [reset = Undefined]
0x209	0x00	PD_CH	JESD204B Channel Power-Down	JESD204B Channel Power-Down Register (address = 0x209) [reset = 0x00]
0x20A	0x00	JEXTRA_A	JESD204B Extra Lane Enable (Link A)	JESD204B Extra Lane Enable (Link A) Register (address = 0x20A) [reset = 0x00]
0x20B	0x00	JEXTRA_B	JESD204B Extra Lane Enable (Link B)	JESD204B Extra Lane Enable (Link B) Register (address = 0x20B) [reset = 0x00]
0x20C-0x20F	Undefined	RESERVED	RESERVED	—

7.6.1.8.1 JESD204B Enable Register (address = 0x200) [reset = 0x01]

Figure 148. JESD204B Enable Register (JESD\_EN)

7	6	5	4	3	2	1	0
RESERVED							JESD_EN
R/W-0000 000							R/W-1

Table 114. JESD\_EN Field Descriptions

Bit	Field	Type	Reset	Description
7-1	RESERVED	R/W	0000 000	RESERVED
0	JESD_EN	R/W	1	0 : Disables JESD204B interface 1 : Enables JESD204B interface Before altering other JESD204B registers, JESD_EN must be cleared. When JESD_EN is 0, the block is held in reset and the serializers are powered down. The clocks are gated off to save power. The LMFC counter is also held in reset, so SYSREF does not align the LMFC. Always set CAL_EN before setting JESD_EN. Always clear JESD_EN before clearing CAL_EN.

**7.6.1.8.2 JESD204B Mode Register (address = 0x201) [reset = 0x02]**
**Figure 149. JESD204B Mode Register (JMODE)**

7	6	5	4	3	2	1	0
RESERVED				JMODE			
R/W-000				R/W-0001 0			

**Table 115. JMODE Field Descriptions**

Bit	Field	Type	Reset	Description
7-5	RESERVED	R/W	000	RESERVED
4-0	JMODE	R/W	0001 0	Specify the JESD204B output mode (including DDC decimation factor). Only change this register when JESD_EN = 0 and CAL_EN = 0.

**7.6.1.8.3 JESD204B K Parameter Register (address = 0x202) [reset = 0x1F]**
**Figure 150. JESD204B K Parameter Register (KM1)**

7	6	5	4	3	2	1	0
RESERVED				KM1			
R/W-000				R/W-1111 1			

**Table 116. KM1 Field Descriptions**

Bit	Field	Type	Reset	Description
7-5	RESERVED	R/W	000	RESERVED
4-0	KM1	R/W	1111 1	K is the number of frames per multiframe and this register must be programmed as K-1. Depending on the JMODE setting, there are constraints on the legal values of K. (default: KM1 = 31, K = 32). Only change this register when JESD_EN is 0.

**7.6.1.8.4 JESD204B Manual SYNC Request Register (address = 0x203) [reset = 0x01]**
**Figure 151. JESD204B Manual SYNC Request Register (JSYNC\_N)**

7	6	5	4	3	2	1	0
RESERVED							JSYNC_N
R/W-0000 000							R/W-1

**Table 117. JSYNC\_N Field Descriptions**

Bit	Field	Type	Reset	Description
7-1	RESERVED	R/W	0000 000	RESERVED
0	JSYNC_N	R/W	1	Set this bit to 0 to request JESD204B synchronization (equivalent to the SYNCSE pin being asserted). For normal operation, leave this bit set to 1. The JSYNC_N register can always generate a synchronization request, regardless of the SYNC_SEL register. However, if the selected sync pin is stuck low, the synchronization request cannot be de-asserted unless SYNC_SEL = 2 is programmed.

**7.6.1.8.5 JESD204B Control Register (address = 0x204) [reset = 0x02]**
**Figure 152. JESD204B Control Register (JCTRL)**

7	6	5	4	3	2	1	0
RESERVED				SYNC_SEL		SFORMAT	SCR
R/W-0000				R/W-00		R/W-1	R/W-0

**Table 118. JCTRL Field Descriptions**

Bit	Field	Type	Reset	Description
7-4	RESERVED	R/W	0000	RESERVED
3-2	SYNC_SEL	R/W	00	0: Use the $\overline{\text{SYNCSE}}$ input for the SYNC~ function (default) 1: Use the TMSTP± differential input for the SYNC~ function; TMSTP_RECV_EN must also be set 2: Do not use any sync input signal (use software SYNC~ through JSYNC_N)
1	SFORMAT	R/W	1	Output sample format for JESD204B samples. 0: Offset binary 1: Signed 2's complement (default)
0	SCR	R/W	0	0: Scrambler disabled (default) 1: Scrambler enabled Only change this register when JESD_EN is 0.

**7.6.1.8.6 JESD204B Test Pattern Control Register (address = 0x205) [reset = 0x00]**
**Figure 153. JESD204B Test Pattern Control Register (JTEST)**

7	6	5	4	3	2	1	0
RESERVED				JTEST			
R/W-0000				R/W-0000			

**Table 119. JTEST Field Descriptions**

Bit	Field	Type	Reset	Description
7-4	RESERVED	R/W	0000	RESERVED
3-0	JTEST	R/W	0000	0: Test mode disabled; normal operation (default) 1: PRBS7 test mode 2: PRBS15 test mode 3: PRBS23 test mode 4: Ramp test mode 5: Transport layer test mode 6: D21.5 test mode 7: K28.5 test mode 8: Repeated ILA test mode 9: Modified RPAT test mode 10: Serial outputs held low 11: Serial outputs held high 12–15: Reserved Only change this register when JESD_EN is 0.

**7.6.1.8.7 JESD204B DID Parameter Register (address = 0x206) [reset = 0x00]**
**Figure 154. JESD204B DID Parameter Register (DID)**

7	6	5	4	3	2	1	0
DID							
R/W-0000 0000							

**Table 120. DID Field Descriptions**

Bit	Field	Type	Reset	Description
7-0	DID	R/W	0000 0000	Specifies the device ID (DID) value that is transmitted during the second multiframe of the JESD204B ILA. Link A transmits DID, and link B transmits DID+1. Bit 0 is ignored and always returns 0 (if an odd number is programmed, that number is decremented to an even number). Only change this register when JESD_EN is 0.

**7.6.1.8.8 JESD204B Frame Character Register (address = 0x207) [reset = 0x00]**
**Figure 155. JESD204B Frame Character Register (FCHAR)**

7	6	5	4	3	2	1	0
RESERVED						FCHAR	
R/W-0000 00						R/W-00	

**Table 121. FCHAR Field Descriptions**

Bit	Field	Type	Reset	Description
7-2	RESERVED	R/W	0000 00	RESERVED
1-0	FCHAR	R/W	00	Specify which comma character is used to denote end-of-frame. This character is transmitted opportunistically (see the <a href="#">Frame and Multiframe Monitoring</a> section). 0: Use K28.7 (default, JESD204B compliant) 1: Use K28.1 (not JESD204B compliant) 2: Use K28.5 (not JESD204B compliant) 3: Reserved When using a JESD204B receiver, always use FCHAR = 0. When using a general-purpose 8b, 10b receiver, the K28.7 character may cause issues. When K28.7 is combined with certain data characters, a false, misaligned comma character can result, and some receivers realign to the false comma. To avoid this condition, program FCHAR to 1 or 2. Only change this register when JESD_EN is 0.



7.6.1.8.9 JESD204B, System Status Register (address = 0x208) [reset = Undefined]

Figure 156. JESD204B, System Status Register (JESD\_STATUS)

7	6	5	4	3	2	1	0
RESERVED	LINK_UP	SYNC_STATUS	REALIGNED	ALIGNED	PLL_LOCKED	RESERVED	
R	R	R	R/W	R/W	R	R	

Table 122. JESD\_STATUS Field Descriptions

Bit	Field	Type	Reset	Description
7	RESERVED	R	Undefined	RESERVED
6	LINK_UP	R	Undefined	When set, this bit indicates that the JESD204B link is up.
5	SYNC_STATUS	R	Undefined	Returns the state of the JESD204B SYNC~ signal. 0: SYNC~ asserted 1: SYNC~ de-asserted
4	REALIGNED	R/W	Undefined	When high, this bit indicates that an internal digital clock, frame clock, or multiframe (LMFC) clock phase was realigned by SYSREF. Write a 1 to clear this bit.
3	ALIGNED	R/W	Undefined	When high, this bit indicates that the multiframe (LMFC) clock phase has been established by SYSREF. The first SYSREF event after enabling the JESD204B encoder will set this bit. Write a 1 to clear this bit.
2	PLL_LOCKED	R	Undefined	When high, this bit indicates that the PLL is locked.
1-0	RESERVED	R	Undefined	RESERVED

7.6.1.8.10 JESD204B Channel Power-Down Register (address = 0x209) [reset = 0x00]

Figure 157. JESD204B Channel Power-Down Register (PD\_CH)

7	6	5	4	3	2	1	0
RESERVED						PD_BCH	PD_ACH
R/W-0000 00						R/W-0	R/W-0

Table 123. PD\_CH Field Descriptions

Bit	Field	Type	Reset	Description
7-2	RESERVED	R/W	0000 00	RESERVED
1	PD_BCH	R/W	0	When set, the B ADC channel is powered down. The digital channels that are bound to the B ADC channel are also powered down (see the <a href="#">digital channel binding register</a> ). Important notes: Set JESD_EN = 0 before changing PD_CH. To power-down both ADC channels, use MODE. If both channels are powered down, then the entire JESD204B subsystem (including the PLL and LMFC) are powered down If the selected JESD204B mode transmits A and B data on link A, and the B digital channel is disabled, link A remains operational, but the B-channel samples are undefined.
0	PD_ACH	R/W	0	When set, the A ADC channel is powered down. The digital channels that are bound to the A ADC channel are also powered down ( <a href="#">digital channel binding register</a> ). Important notes: Set JESD_EN = 0 before changing PD_CH. To power-down both ADC channels, use MODE. If both channels are powered down, then the entire JESD204B subsystem (including the PLL and LMFC) are powered down If the selected JESD204B mode transmits A and B data on link A, and the B digital channel is disabled, link A remains operational, but the B-channel samples are undefined.

**7.6.1.8.11 JESD204B Extra Lane Enable (Link A) Register (address = 0x20A) [reset = 0x00]**
**Figure 158. JESD204B Extra Lane Enable (Link A) Register (JEXTRA\_A)**

7	6	5	4	3	2	1	0
EXTRA_LANE_A						EXTRA_SER_A	
R/W-0000 000						R/W-0	

**Table 124. JESD204B Extra Lane Enable (Link A) Field Descriptions**

Bit	Field	Type	Reset	Description
7-1	EXTRA_LANE_A	R/W	0000 000	Program these register bits to enable extra lanes (even if the selected JMODE does not require the lanes to be enabled). EXTRA_LANE_A(n) enables An (n = 1 to 7). This register enables the link layer clocks for the affected lanes. To also enable the extra serializes set EXTRA_SER_A = 1.
0	EXTRA_SER_A	R/W	0	0: Only the link layer clocks for extra lanes are enabled. 1: Serializers for extra lanes are also enabled. Use this mode to transmit data from the extra lanes. Important notes: Only change this register when JESD_EN = 0. The bit-rate and mode of the extra lanes are set by the JMODE and JTEST parameters. This register does not override the PD_CH register, so ensure that the link is enabled to use this feature. To enable serializer n, the lower number lanes 0 to n-1 must also be enabled, otherwise serializer n does not receive a clock.

**7.6.1.8.12 JESD204B Extra Lane Enable (Link B) Register (address = 0x20B) [reset = 0x00]**
**Figure 159. JESD204B Extra Lane Enable (Link B) Register (JEXTRA\_B)**

7	6	5	4	3	2	1	0
EXTRA_LANE_B						EXTRA_SER_B	
R/W-0000 000						R/W-0	

**Table 125. JESD204B Extra Lane Enable (Link B) Field Descriptions**

Bit	Field	Type	Reset	Description
7-1	EXTRA_LANE_B	R/W	0000 000	Program these register bits to enable extra lanes (even if the selected JMODE does not require the lanes to be enabled). EXTRA_LANE_B(n) enables Bn (n = 1 to 7). This register enables the link layer clocks for the affected lanes. To also enable the extra serializes set EXTRA_SER_B = 1.
0	EXTRA_SER_B	R/W	0	0: Only the link layer clocks for extra lanes are enabled. 1: Serializers for extra lanes are also enabled. Use this mode to transmit data from the extra lanes. Important notes: Only change this register when JESD_EN = 0. The bit-rate and mode of the extra lanes are set by the JMODE and JTEST parameters. This register does not override the PD_CH register, so ensure that the link is enabled to use this feature. To enable serializer n, the lower number lanes 0 to n-1 must also be enabled, otherwise serializer n does not receive a clock.

**7.6.1.9 Digital Down Converter Registers (0x210-0x2AF)**
**Table 126. Digital Down Converter and Overrange Registers**

ADDRESS	RESET	ACRONYM	REGISTER NAME	SECTION
0x210	0x00	DDC_CFG	DDC Configuration Register	DDC Configuration Register (address = 0x210) [reset = 0x00]
0x211	0xF2	OVR_T0	Overrange Threshold 0 Register	Overrange Threshold 0 Register (address = 0x211) [reset = 0xF2]
0x212	0xAB	OVR_T1	Overrange Threshold 1 Register	Overrange Threshold 1 Register (address = 0x212) [reset = 0xAB]
0x213	0x07	OVR_CFG	Overrange Configuration Register	Overrange Configuration Register (address = 0x213) [reset = 0x07]
0x214	0x00	CMODE	DDC Configuration Preset Mode Register	DDC Configuration Preset Mode Register (address = 0x214) [reset = 0x00]
0x215	0x00	CSEL	DDC Configuration Preset Select Register	DDC Configuration Preset Select Register (address = 0x215) [reset = 0x00]
0x216	0x02	DIG_BIND	Digital Channel Binding Register	Digital Channel Binding Register (address = 0x216) [reset = 0x02]
0x217-0x218	0x0000	NCO_RDIV	Rational NCO Reference Divisor Register	Rational NCO Reference Divisor Register (address = 0x217 to 0x218) [reset = 0x0000]
0x219	0x02	NCO_SYNC	NCO Synchronization Register	NCO Synchronization Register (address = 0x219) [reset = 0x02]
0x21A-0x21F	Undefined	RESERVED	RESERVED	—
0x220-0x223	0xC0000000	FREQA0	NCO Frequency (DDC A Preset 0)	NCO Frequency (DDC A or DDC B and Preset x) Register (address = see Table 126) [reset = see Table 126]
0x224-0x225	0x0000	PHASEA0	NCO Phase (DDC A Preset 0)	NCO Phase (DDC A or DDC B and Preset x) Register (address = see Table 126) [reset = see Table 126]
0x226-0x227	Undefined	RESERVED	RESERVED	—
0x228-0x22B	0xC0000000	FREQA1	NCO Frequency (DDC A Preset 1)	NCO Frequency (DDC A or DDC B and Preset x) Register (address = see Table 126) [reset = see Table 126]
0x22C-0x22D	0x0000	PHASEA1	NCO Phase (DDC A Preset 1)	NCO Phase (DDC A or DDC B and Preset x) Register (address = see Table 126) [reset = see Table 126]
0x22E-0x22F	Undefined	RESERVED	RESERVED	—
0x230-0x233	0xC0000000	FREQA2	NCO Frequency (DDC A Preset 2)	NCO Frequency (DDC A or DDC B and Preset x) Register (address = see Table 126) [reset = see Table 126]
0x234-0x235	0x0000	PHASEA2	NCO Phase (DDC A Preset 2)	NCO Phase (DDC A or DDC B and Preset x) Register (address = see Table 126) [reset = see Table 126]
0x236-0x237	Undefined	RESERVED	RESERVED	—
0x238-0x23B	0xC0000000	FREQA3	NCO Frequency (DDC A Preset 3)	NCO Frequency (DDC A or DDC B and Preset x) Register (address = see Table 126) [reset = see Table 126]
0x23C-0x23D	0x0000	PHASEA3	NCO Phase (DDC A Preset 3)	NCO Phase (DDC A or DDC B and Preset x) Register (address = see Table 126) [reset = see Table 126]
0x23E-0x23F	Undefined	RESERVED	RESERVED	—
0x240-0x243	0xC0000000	FREQB0	NCO Frequency (DDC B Preset 0)	NCO Frequency (DDC A or DDC B and Preset x) Register (address = see Table 126) [reset = see Table 126]
0x244-0x245	0x0000	PHASEB0	NCO Phase (DDC B Preset 0)	NCO Phase (DDC A or DDC B and Preset x) Register (address = see Table 126) [reset = see Table 126]
0x246-0x247	Undefined	RESERVED	RESERVED	—
0x248-0x24B	0xC0000000	FREQB1	NCO Frequency (DDC B Preset 1)	NCO Frequency (DDC A or DDC B and Preset x) Register (address = see Table 126) [reset = see Table 126]
0x24C-0x24D	0x0000	PHASEB1	NCO Phase (DDC B Preset 1)	NCO Phase (DDC A or DDC B and Preset x) Register (address = see Table 126) [reset = see Table 126]
0x24E-0x24F	Undefined	RESERVED	RESERVED	—
0x250-0x253	0xC0000000	FREQB2	NCO Frequency (DDC B Preset 2)	NCO Frequency (DDC A or DDC B and Preset x) Register (address = see Table 126) [reset = see Table 126]
0x254-0x255	0x0000	PHASEB2	NCO Phase (DDC B Preset 2)	NCO Phase (DDC A or DDC B and Preset x) Register (address = see Table 126) [reset = see Table 126]
0x256-0x257	Undefined	RESERVED	RESERVED	—
0x258-0x25B	0xC0000000	FREQB3	NCO Frequency (DDC B Preset 3)	NCO Frequency (DDC A or DDC B and Preset x) Register (address = see Table 126) [reset = see Table 126]
0x25C-0x25D	0x0000	PHASEB3	NCO Phase (DDC B Preset 3)	NCO Phase (DDC A or DDC B and Preset x) Register (address = see Table 126) [reset = see Table 126]

**Table 126. Digital Down Converter and Overrange Registers (continued)**

ADDRESS	RESET	ACRONYM	REGISTER NAME	SECTION
0x25E-0x296	Undefined	RESERVED	RESERVED	—
0x297	Undefined	SPIN_ID	Spin Identification Value	Spin Identification Register (address = 0x297) [reset = Undefined]
0x298-0x2AF	Undefined	RESERVED	RESERVED	—

**7.6.1.9.1 DDC Configuration Register (address = 0x210) [reset = 0x00]**

**Figure 160. DDC Configuration Register (DDC\_CFG)**

7	6	5	4	3	2	1	0
RESERVED			D4_AP87		D2_HIGH_PASS	INVERT_SPECTRUM	BOOST
R/W-0000			R/W-0		R/W-0	R/W-0	R/W-0

**Table 127. DDC\_CFG Field Descriptions**

Bit	Field	Type	Reset	Description
7-4	RESERVED	R/W	0000	RESERVED
3	D4_AP87	R/W	0	0: Decimate-by-4 mode uses 80% alias protection, > 80-dB suppression 1: Decimate-by-4 mode uses 87.5% alias protection, > 60-dB suppression
2	D2_HIGH_PASS	R/W	0	0: Decimate-by-2 mode uses a low-pass filter 1: Decimate-by-2 mode uses a high-pass filter. Decimating the high-pass signal causes spectral inversion. This inversion can be undone by setting INVERT_SPECTRUM.
1	INVERT_SPECTRUM	R/W	0	0: No inversion applied to output spectrum 1: Output spectrum is inverted This register only applies when the DDC is enabled and is producing a real output (not complex). The spectrum is inverted by mixing the signal with FSOUT / 2 (for example, invert all odd samples).
0	BOOST	R/W	0	DDC gain control. Only applies to DDC modes with complex decimation. 0: Final filter has 0-dB gain (default) 1: Final filter has 6.02-dB gain. Only use this setting when certain that the negative image of the input signal is filtered out by the DDC, otherwise digital clipping may occur.

**7.6.1.9.2 Overrange Threshold 0 Register (address = 0x211) [reset = 0xF2]**

**Figure 161. Overrange Threshold 0 Register (OVR\_T0)**

7	6	5	4	3	2	1	0
OVR_T0							
R/W-1111 0010							

**Table 128. OVR\_T0 Field Descriptions**

Bit	Field	Type	Reset	Description
7-0	OVR_T0	R/W	1111 0010	Overrange threshold 0. This parameter defines the absolute sample level that causes control bit 0 to be set. The detection level in dBFS (peak) is: $20_{\log_{10}}(\text{OVR\_T0} / 256)$ Default: 0xF2 = 242 → -0.5 dBFS.

**7.6.1.9.3 Overrange Threshold 1 Register (address = 0x212) [reset = 0xAB]**
**Figure 162. Overrange Threshold 1 Register (OVR\_T1)**

7	6	5	4	3	2	1	0
OVR_T1							
R/W-1010 1011							

**Table 129. OVR\_T1 Field Descriptions**

Bit	Field	Type	Reset	Description
7-0	OVR_T1	R/W	1010 1011	Overrange threshold 1. This parameter defines the absolute sample level that causes control bit 1 to be set. The detection level in dBFS (peak) is: $20_{\log_{10}}(\text{OVR\_T1} / 256)$ Default: 0xAB = 171 → -3.5 dBFS.

**7.6.1.9.4 Overrange Configuration Register (address = 0x213) [reset = 0x07]**
**Figure 163. Overrange Configuration Register (OVR\_CFG)**

7	6	5	4	3	2	1	0
RESERVED				OVR_EN	OVR_N		
R/W-0000				R/W-0	R/W-111		

**Table 130. OVR\_CFG Field Descriptions**

Bit	Field	Type	Reset	Description
7-4	RESERVED	R/W	0000 0	RESERVED
3	OVR_EN	R/W	0	Enables overrange status output pins when set high. The ORA0, ORA1, ORB0, and ORB1 outputs are held low when OVR_EN is set low. This register only effects the overrange output pins (ORxx) and not the overrange status embedded in the data samples.
2-0	OVR_N <sup>(1)</sup>	R/W	111	Program this register to adjust the pulse extension for the ORA0, ORA1 and ORB0, ORB1 outputs. The minimum pulse duration of the overrange outputs is $8 \times 2^{\text{OVR\_N}}$ DEVCLK cycles. Incrementing this field doubles the monitoring period.

(1) Changing the OVR\_N setting while JESD\_EN=1 may cause the phase of the monitoring period to change.

**7.6.1.9.5 DDC Configuration Preset Mode Register (address = 0x214) [reset = 0x00]**
**Figure 164. DDC Configuration Preset Mode Register (CMODE)**

7	6	5	4	3	2	1	0
RESERVED						CMODE	
R/W-0000 00						R/W-00	

**Table 131. CMODE Field Descriptions**

Bit	Field	Type	Reset	Description
7-2	RESERVED	R/W	0000 00	RESERVED
1-0	CMODE	R/W	00	The NCO frequency and phase for DDC A are set by the FREQA <sub>x</sub> and PHASEA <sub>x</sub> registers and the NCO frequency and phase for DDC B are set by the FREQB <sub>x</sub> and PHASEB <sub>x</sub> registers, where x is the configuration preset (0 through 3). 0: Use CSEL register to select the active NCO configuration preset for DDC A and DDC B 1: Use NCOA[1:0] pins to select the active NCO configuration preset for DDC A and use NCOB[1:0] pins to select the active NCO configuration preset for DDC B 2: Use NCOA[1:0] pins to select the active NCO configuration preset for both DDC A and DDC B 3: Reserved

**7.6.1.9.6 DDC Configuration Preset Select Register (address = 0x215) [reset = 0x00]**
**Figure 165. DDC Configuration Preset Select Register (CSEL)**

7	6	5	4	3	2	1	0
RESERVED				CSELB		CSELA	
R/W-0000				R/W-00		R/W-00	

**Table 132. CSEL Field Descriptions**

Bit	Field	Type	Reset	Description
7-4	RESERVED	R/W	0000	RESERVED
3-2	CSELB	R/W	00	When CMODE = 0, this register is used to select the active NCO configuration preset for DDC B.
1-0	CSELA	R/W	00	When CMODE = 0, this register is used to select the active NCO configuration preset for DDC A. Example: If CSELA = 0, then FREQA0 and PHASEA0 are the active settings. If CSELA = 1, then FREQA1 and PHASEA1 are the active settings.

**7.6.1.9.7 Digital Channel Binding Register (address = 0x216) [reset = 0x02]**
**Figure 166. Digital Channel Binding Register (DIG\_BIND)**

7	6	5	4	3	2	1	0
RESERVED						DIG_BIND_B	DIG_BIND_A
R/W-0000 00						R/W-1	R/W-0

**Table 133. DIG\_BIND Field Descriptions**

Bit	Field	Type	Reset	Description
7-2	RESERVED	R/W	0000 00	RESERVED
1	DIG_BIND_B	R/W	0	Digital channel B input select: 0: Digital channel B receives data from ADC channel A 1: Digital channel B receives data from ADC channel B (default)
0	DIG_BIND_A	R/W	0	Digital channel A input select: 0: Digital channel A receives data from ADC channel A (default) 1: Digital channel A receives data from ADC channel B When using single-channel mode, always use the default setting for DIG_BIND or the device does not work. Set JESD_EN = 0 and CAL_EN = 0 before changing DIG_BIND. The DIG_BIND setting is combined with PD_ACH, PD_BCH to determine if a digital channel is powered down. Each digital channel (and link) is powered down when the ADC channel it is bound to is powered down (by PD_ACH, PD_BCH).

**7.6.1.9.8 Rational NCO Reference Divisor Register (address = 0x217 to 0x218) [reset = 0x0000]**
**Figure 167. Rational NCO Reference Divisor Register (NCO\_RDIV)**

15	14	13	12	11	10	9	8
NCO_RDIV[15:8]							
R/W-0000 0000							
7	6	5	4	3	2	1	0
NCO_RDIV[7:0]							
R/W-0000 0000							

**Table 134. NCO\_RDIV Field Descriptions**

Bit	Field	Type	Reset	Description
15-0	NCO_RDIV	R/W	0x0000h	Sometimes the 32-bit NCO frequency word does not provide the desired frequency step size and can only approximate the desired frequency. This condition results in a frequency error. Use this register to eliminate the frequency error. This register is used for all configuration presets; see the <a href="#">Rational NCO Frequency Setting Mode</a> section.

7.6.1.9.9 NCO Synchronization Register (address = 0x219) [reset = 0x02]

Figure 168. NCO Synchronization Register (NCO\_SYNC)

7	6	5	4	3	2	1	0
RESERVED					NCO_SYNC_ILA		NCO_SYNC_NEXT
R/W-0000 00					R/W-1		R/W-0

Table 135. NCO\_SYNC Field Descriptions

Bit	Field	Type	Reset	Description
7-2	RESERVED	R/W	0000 00	RESERVED
1	NCO_SYNC_ILA	R/W	0	When this bit is set, the NCO phase is initialized by the LMFC edge that starts the ILA sequence (default).
0	NCO_SYNC_NEXT	R/W	0	After writing a 0 and then a 1 to this bit, the next SYSREF rising edge initializes the NCO phase. When the NCO phase is initialized by SYSREF, the NCO does not reinitialize on future SYSREF edges unless a 0 and a 1 is written to this bit again. Follow these steps to align the NCO in multiple parts: <ul style="list-style-type: none"> <li>• Ensure the device is powered up, JESD_EN is set, and the device clock is running.</li> <li>• Ensure that SYSREF is disabled (not toggling).</li> <li>• Program NCO_SYNC_ILA = 0 on all devices.</li> <li>• Write NCO_SYNC_NEXT = 0 on all devices.</li> <li>• Write NCO_SYNC_NEXT = 1 on all devices. NCO sync is armed.</li> <li>• Instruct the SYSREF source to generate 1 or more SYSREF pulses.</li> <li>• All devices initialize their NCO using the first SYSREF rising edge.</li> </ul>

7.6.1.9.10 NCO Frequency (DDC A or DDC B and Preset x) Register (address = see Table 126) [reset = see Table 126]

Figure 169. NCO Frequency (DDC A or DDC B and Preset x) Register (FREQAx or FREQBx)

31	30	29	28	27	26	25	24
FREQAx[31:24] or FREQBx[31:24]							
R/W-0xC0							
23	22	21	20	19	18	17	16
FREQAx[23:16] or FREQBx[23:16]							
R/W-0x00							
15	14	13	12	11	10	9	8
FREQAx[15:8] or FREQBx[15:8]							
R/W-0x00							
7	6	5	4	3	2	1	0
FREQAx[7:0] or FREQBx[7:0]							
R/W-0x00							

Table 136. FREQAx or FREQBx Field Descriptions

Bit	Field	Type	Reset	Description
31-0	FREQAx or FREQBx	R/W	See Table 126	Changing this register after the JESD204B interface is running results in non-deterministic NCO phase. If deterministic phase is required, the JESD204B interface must be re-initialized after changing this register. This register can be interpreted as signed or unsigned; see the <a href="#">Basic NCO Frequency Setting Mode</a> section.



7.6.1.9.11 NCO Phase (DDC A or DDC B and Preset x) Register (address = see [Table 126](#)) [reset = see [Table 126](#)]

Figure 170. NCO Phase (DDC A or DDC B and Preset x) Register (PHASEAx or PHASEBx)

15	14	13	12	11	10	9	8
PHASEAx[15:8] or PHASEBx[15:8]							
R/W-0x00							
7	6	5	4	3	2	1	0
PHASEAx[7:0] or PHASEBx[7:0]							
R/W-0x00							

Table 137. PHASEAx or PHASEBx Field Descriptions

Bit	Field	Type	Reset	Description
15-0	PHASEAx or PHASEBx	R/W	See <a href="#">Table 126</a>	This value is MSB-justified into a 32-bit field and then added to the phase accumulator. This register can be interpreted as signed or unsigned; see the <a href="#">NCO Phase Offset Setting</a> section.

7.6.1.10 Spin Identification Register (address = 0x297) [reset = Undefined]

Figure 171. Spin Identification Register (SPIN\_ID)

7	6	5	4	3	2	1	0
RESERVED				SPIN_ID			
R-000				R			

Table 138. SPIN\_ID Field Descriptions

Bit	Field	Type	Reset	Description
7-5	RESERVED	R	000	RESERVED
4-0	SPIN_ID	R	0	Spin identification value. 0 : ADC12DJ3200

## 7.6.2 SYSREF Calibration Registers (0x2B0 to 0x2BF)

**Table 139. SYSREF Calibration Registers**

ADDRESS	RESET	ACRONYM	REGISTER NAME	SECTION
0x2B0	0x00	SRC_EN	SYSREF Calibration Enable Register	SYSREF Calibration Enable Register (address = 0x2B0) [reset = 0x00]
0x2B1	0x05	SRC_CFG	SYSREF Calibration Configuration Register	SYSREF Calibration Configuration Register (address = 0x2B1) [reset = 0x05]
0x2B2-0x2B4	Undefined	SRC_STATUS	SYSREF Calibration Status	SYSREF Calibration Status Register (address = 0x2B2 to 0x2B4) [reset = Undefined]
0x2B5-0x2B7	0x00	TAD	DEVCLK Aperture Delay Adjustment Register	DEVCLK Aperture Delay Adjustment Register (address = 0x2B5 to 0x2B7) [reset = 0x000000]
0x2B8	0x00	TAD_RAMP	DEVCLK Timing Adjust Ramp Control Register	DEVCLK Timing Adjust Ramp Control Register (address = 0x2B8) [reset = 0x00]
0x2B9-0x2BF	Undefined	RESERVED	RESERVED	—

### 7.6.2.1 SYSREF Calibration Enable Register (address = 0x2B0) [reset = 0x00]

**Figure 172. SYSREF Calibration Enable Register (SRC\_EN)**

7	6	5	4	3	2	1	0
RESERVED							SRC_EN
R/W-0000 000							R/W-0

**Table 140. SRC\_EN Field Descriptions**

Bit	Field	Type	Reset	Description
7-1	RESERVED	R/W	0000 000	RESERVED
0	SRC_EN	R/W	0	0: SYSREF calibration disabled; use the TAD register to manually control the TAD[16:0] output and adjust the DEVCLK delay (default) 1: SYSREF calibration enabled; the DEVCLK delay is automatically calibrated; the TAD register is ignored A 0-to-1 transition on SRC_EN starts the SYSREF calibration sequence. Program SRC_CFG before setting SRC_EN. Ensure that ADC calibration is not currently running before setting SRC_EN.

**7.6.2.2 SYSREF Calibration Configuration Register (address = 0x2B1) [reset = 0x05]**
**Figure 173. SYSREF Calibration Configuration Register (SRC\_CFG)**

7	6	5	4	3	2	1	0
RESERVED				SRC_AVG		SRC_HDUR	
R/W-0000				R/W-01		R/W-01	

**Table 141. SRC\_CFG Field Descriptions**

Bit	Field	Type	Reset	Description
7-4	RESERVED	R/W	0000 00	RESERVED
3-2	SRC_AVG	R/W	01	Specifies the amount of averaging used for SYSREF calibration. Larger values increase calibration time and reduce the variance of the calibrated value. 0: 4 averages 1: 16 averages 2: 64 averages 3: 256 averages
1-0	SRC_HDUR	R/W	01	Specifies the duration of each high-speed accumulation for SYSREF Calibration. If the SYSREF period exceeds the supported value, the calibration fails. Larger values increase calibration time and support longer SYSREF periods. For a given SYSREF period, larger values also reduce the variance of the calibrated value. 0: 4 cycles per accumulation, max SYSREF period of 85 DEVCLK cycles 1: 16 cycles per accumulation, max SYSREF period of 1100 DEVCLK cycles 2: 64 cycles per accumulation, max SYSREF period of 5200 DEVCLK cycles 3: 256 cycles per accumulation, max SYSREF period of 21580 DEVCLK cycles Max duration of SYSREF calibration is bounded by: $T_{SYSREFCAL}(\text{in DEVCLK cycles}) = 256 \times 19 \times 4^{(SRC\_AVG + SRC\_HDUR + 2)}$

**7.6.2.3 SYSREF Calibration Status Register (address = 0x2B2 to 0x2B4) [reset = Undefined]**
**Figure 174. SYSREF Calibration Status Register (SRC\_STATUS)**

23	22	21	20	19	18	17	16
RESERVED						SRC_DONE	SRC_TAD[16]
R						R	R
15	14	13	12	11	10	9	8
SRC_TAD[15:8]							
R							
7	6	5	4	3	2	1	0
SRC_TAD[7:0]							
R							

**Table 142. SRC\_STATUS Field Descriptions**

Bit	Field	Type	Reset	Description
23-18	RESERVED	R	Undefined	RESERVED
17	SRC_DONE	R	Undefined	This bit returns a 1 when SRC_EN = 1 and SYSREF calibration is complete.
16-0	SRC_TAD	R	Undefined	This field returns the value for TAD[16:0] computed by the SYSREF calibration. This field is only valid if SRC_DONE = 1.

**7.6.2.4 DEVCLK Aperture Delay Adjustment Register (address = 0x2B5 to 0x2B7) [reset = 0x000000]**
**Figure 175. DEVCLK Aperture Delay Adjustment Register (TAD)**

23	22	21	20	19	18	17	16
RESERVED							TAD_INV
R/W-0000 000							R/W-0
15	14	13	12	11	10	9	8
TAD_COARSE							
R/W-0000 0000							
7	6	5	4	3	2	1	0
TAD_FINE							
R/W-0000 0000							

**Table 143. TAD Field Descriptions**

Bit	Field	Type	Reset	Description
23-17	RESERVED	R/W	0000 000	RESERVED
16	TAD_INV	R/W	0	Invert DEVCLK by setting this bit equal to 1.
15-8	TAD_COARSE	R/W	0000 0000	This register controls the DEVCLK aperture delay adjustment when SRC_EN = 0. Use this register to manually control the DEVCLK aperture delay when SYSREF calibration is disabled. If ADC calibration or JESD204B is running, TI recommends gradually increasing or decreasing this value (1 code at a time) to avoid clock glitches. See the <a href="#">Switching Characteristics</a> table for TAD_COARSE resolution.
7-0	TAD_FINE	R/W	0000 0000	See the <a href="#">Switching Characteristics</a> table for TAD_FINE resolution.

**7.6.2.5 DEVCLK Timing Adjust Ramp Control Register (address = 0x2B8) [reset = 0x00]**
**Figure 176. DEVCLK Timing Adjust Ramp Control Register (TAD\_RAMP)**

7	6	5	4	3	2	1	0
RESERVED						TAD_RAMP_RATE	TAD_RAMP_EN
R/W-0000 00						R/W-0	R/W-0

**Table 144. TAD\_RAMP Field Descriptions**

Bit	Field	Type	Reset	Description
7-2	RESERVED	R/W	0000 00	RESERVED
1	TAD_RAMP_RATE	R/W	0	Specifies the ramp rate for the TAD[15:8] output when the TAD[15:8] register is written when TAD_RAMP_EN = 1. 0: TAD[15:8] ramps up or down one code per 256 DEVCLK cycles. 1: TAD[15:8] ramps up or down 4 codes per 256 DEVCLK cycles.
0	TAD_RAMP_EN	R/W	0	TAD ramp enable. Set this bit if coarse TAD adjustments are desired to ramp up or down instead of changing abruptly. 0: After writing the TAD[15:8] register the aperture delay is updated within 1024 DEVCLK cycles 1: After writing the TAD[15:8] register the aperture delay ramps up or down until the aperture delay matches the TAD[15:8] register

### 7.6.3 Alarm Registers (0x2C0 to 0x2C2)

**Table 145. Alarm Registers**

ADDRESS	RESET	ACRONYM	REGISTER NAME	SECTION
0x2C0	Undefined	ALARM	Alarm Interrupt Status Register	Alarm Interrupt Register (address = 0x2C0) [reset = Undefined]
0x2C1	0x1F	ALM_STATUS	Alarm Status Register	Alarm Status Register (address = 0x2C1) [reset = 0x1F]
0x2C2	0x1F	ALM_MASK	Alarm Mask Register	Alarm Mask Register (address = 0x2C2) [reset = 0x1F]

#### 7.6.3.1 Alarm Interrupt Register (address = 0x2C0) [reset = Undefined]

**Figure 177. Alarm Interrupt Register (ALARM)**

7	6	5	4	3	2	1	0
RESERVED							ALARM
R							R

**Table 146. ALARM Field Descriptions**

Bit	Field	Type	Reset	Description
7-1	RESERVED	R	Undefined	RESERVED
0	ALARM	R	Undefined	This bit returns a 1 whenever any alarm occurs that is unmasked in the ALM_STATUS register. Use ALM_MASK to mask (disable) individual alarms. CAL_STATUS_SEL can be used to drive the ALARM bit onto the CALSTAT output pin to provide a hardware alarm interrupt signal.

#### 7.6.3.2 Alarm Status Register (address = 0x2C1) [reset = 0x1F]

**Figure 178. Alarm Status Register (ALM\_STATUS)**

7	6	5	4	3	2	1	0
RESERVED		PLL_ALM	LINK_ALM	REALIGNED_ALM	NCO_ALM	CLK_ALM	
R/W-000		R/W-1	R/W-1	R/W-1	R/W-1	R/W-1	R/W-1

**Table 147. ALM\_STATUS Field Descriptions**

Bit	Field	Type	Reset	Description
7-5	RESERVED	R/W	000	RESERVED
4	PLL_ALM	R/W	1	PLL lock lost alarm. This bit is set whenever the PLL is not locked. Write a 1 to clear this bit.
3	LINK_ALM	R/W	1	Link alarm. This bit is set whenever the JESD204B link is enabled, but is not in the DATA_ENC state. Write a 1 to clear this bit.
2	REALIGNED_ALM	R/W	1	Realigned alarm. This bit is set whenever SYSREF causes the internal clocks (including the LMFC) to be realigned. Write a 1 to clear this bit.
1	NCO_ALM	R/W	1	NCO alarm. This bit can be used to detect an upset to the NCO phase. This bit is set when any of the following occur: <ul style="list-style-type: none"> <li>The NCOs are disabled (JESD_EN = 0)</li> <li>The NCOs are synchronized (intentionally or unintentionally)</li> <li>Any phase accumulators in channel A do not match channel B</li> </ul> Write a 1 to clear this bit.
0	CLK_ALM	R/W	1	Clock alarm. This bit can be used to detect an upset to the digital block and JESD204B clocks. This bit is set whenever the internal clock dividers for the A and B channels do not match. Write a 1 to clear this bit.

**7.6.3.3 Alarm Mask Register (address = 0x2C2) [reset = 0x1F]**
**Figure 179. Alarm Mask Register (ALM\_MASK)**

7	6	5	4	3	2	1	0
RESERVED			MASK_PLL_ALM	MASK_LINK_ALM	MASK_REALIGNED_ALM	MASK_NCO_ALM	MASK_CLK_ALM
R/W-000			R/W-1	R/W-1	R/W-1	R/W-1	R/W-1

**Table 148. ALM\_MASK Field Descriptions**

Bit	Field	Type	Reset	Description
7-5	RESERVED	R/W	000	RESERVED
4	MASK_PLL_ALM	R/W	1	When set, PLL_ALM is masked and does not impact the ALARM register bit.
3	MASK_LINK_ALM	R/W	1	When set, LINK_ALM is masked and does not impact the ALARM register bit.
2	MASK_REALIGNED_ALM	R/W	1	When set, REALIGNED_ALM is masked and does not impact the ALARM register bit.
1	MASK_NCO_ALM	R/W	1	When set, NCO_ALM is masked and does not impact the ALARM register bit.
0	MASK_CLK_ALM	R/W	1	When set, CLK_ALM is masked and does not impact the ALARM register bit.

## 8 Application and Implementation

注

Information in the following applications sections is not part of the TI component specification, and TI does not warrant its accuracy or completeness. TI's customers are responsible for determining suitability of components for their purposes. Customers should validate and test their design implementation to confirm system functionality.

### 8.1 Application Information

The ADC12DJ3200 can be used in a wide range of applications including radar, satellite communications, test equipment (communications testers and oscilloscopes), and software-defined radios (SDRs). The wide input bandwidth enables direct RF sampling to at least 8 GHz and the high sampling rate allows signal bandwidths of greater than 2 GHz. The *Typical Applications* section describes one configuration that meets the needs of a number of these applications.

### 8.2 Typical Applications

#### 8.2.1 Wideband RF Sampling Receiver

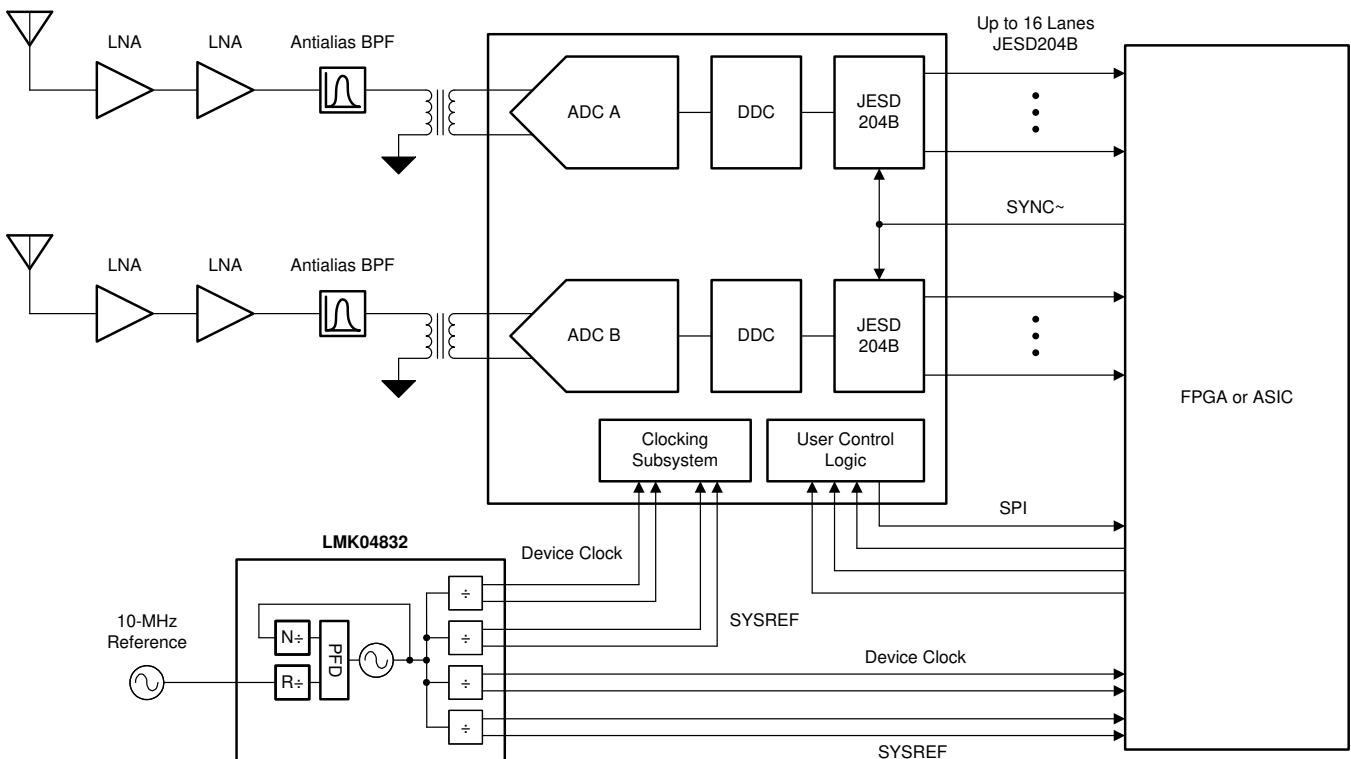

Copyright © 2018, Texas Instruments Incorporated

图 180. Typical Configuration for Wideband RF Sampling

#### 8.2.1.1 Design Requirements

##### 8.2.1.1.1 Input Signal Path

Use appropriate band-limiting filters to reject unwanted frequencies in the input signal path.

A 1:2 balun transformer is needed to convert the 50-Ω, single-ended signal to 100-Ω differential for input to the ADC. The balun outputs can be either AC-coupled, or directly connected to the ADC differential inputs, which are terminated internally to GND.

## Typical Applications (接下页)

Drivers must be selected to provide any needed signal gain and that have the necessary bandwidth capabilities.

Baluns must be selected to cover the needed frequency range, have a 1:2 impedance ratio, and have acceptable gain and phase balance over the frequency range of interest. 表 149 lists a number of recommended baluns for different frequency ranges.

**表 149. Recommended Baluns**

PART NUMBER	MANUFACTURER <sup>(1)</sup>	MINIMUM FREQUENCY (MHz)	MAXIMUM FREQUENCY (MHz)
BAL-0009SMG	Marki Microwave	0.5	9000
BAL-0208SMG	Marki Microwave	2000	8000
TCM2-43X+	Mini-Circuits	10	4000
TCM2-33WX+	Mini-Circuits	10	3000
B0430J50100AHF	Anaren	400	3000

(1) See the [Third-Party Products Disclaimer](#) section.

### 8.2.1.1.2 Clocking

The ADC12DJ3200 clock inputs must be AC-coupled to the device to ensure rated performance. The clock source must have extremely low jitter (integrated phase noise) to enable rated performance. Recommended clock synthesizers include the [LMX2594](#), [LMX2592](#), and [LMX2582](#).

The JESD204B data converter system (ADC plus FPGA) requires additional SYSREF and device clocks. The [LMK04828](#), [LMK04826](#), and [LMK04821](#) devices are suitable to generate these clocks. Depending on the ADC clock frequency and jitter requirements, this device may also be used as the system clock synthesizer or as a device clock and SYSREF distribution device when multiple ADC12DJ3200 devices are used in a system.

### 8.2.1.2 Detailed Design Procedure

Certain component values used in conjunction with the ADC12DJ3200 must be calculated based on system parameters. Those items are covered in this section.

#### 8.2.1.2.1 Calculating Values of AC-Coupling Capacitors

AC-coupling capacitors are used in the input CLK± and JESD204B output data pairs. The capacitor values must be large enough to address the lowest frequency signals of interest, but not so large as to cause excessively long startup biasing times, or unwanted parasitic inductance.

The minimum capacitor value can be calculated based on the lowest frequency signal that is transferred through the capacitor. Given a 50-Ω single-ended clock or data path impedance, good practice is to set the capacitor impedance to be <1 Ω at the lowest frequency of interest. This setting ensures minimal impact on signal level at that frequency. For the CLK± path, the minimum-rated clock frequency is 800 MHz. Therefore, the minimum capacitor value can be calculated from:

$$Z_C = 1/(2 \times \pi \times f_{CLK} \times C) \quad (12)$$

Setting  $Z_C = 1 \Omega$  and rearranging gives:

$$C = 1/(2 \times \pi \times 800 \text{ MHz} \times 1 \Omega) = 199 \text{ pF} \quad (13)$$

Therefore, a capacitance value of at least 199 pF is needed to provide the low-frequency response for the CLK± path. If the minimum clock frequency is higher than 800 MHz, this calculation can be revisited for that frequency. Similar calculations can be done for the JESD204B output data capacitors based on the minimum frequency in that interface. Capacitors must also be selected for good response at high frequencies, and with dimensions that match the high-frequency signal traces they are connected to. Capacitors of the 0201 size are frequently well suited to these applications.



### 8.2.1.3 Application Curves

The ADC12DJ3200 can be used in a number of different operating modes to suit multiple applications. [图 181](#) to [图 183](#) describe operation with a 497.77-MHz input signal in the following configurations:

- 6.4-GSPS, single-input mode, 12-bit output, JMODE0
- 3.2-GSPS, dual-input mode, 12-bit output, JMODE2
- 3.2 GSPS with 16x decimation, dual-input mode, 15-bit complex output, JMODE11



图 181. FFT for 497.77-MHz Input Signal, 6.4 GSPS, JMODE0



图 182. FFT for 497.77-MHz Input Signal, 3.2 GSPS, JMODE2

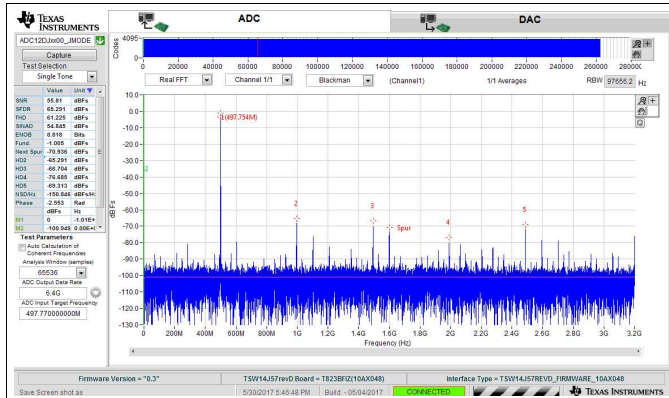

图 183. FFT for 497.77-MHz Input Signal, 3.2 GSPS, Decimation-by-16,  $f_{NCO} = 500$  MHz, JMODE11

## 8.2.2 Reconfigurable Dual-Channel 2.5-GSPS or Single-Channel 5.0-GSPS Oscilloscope

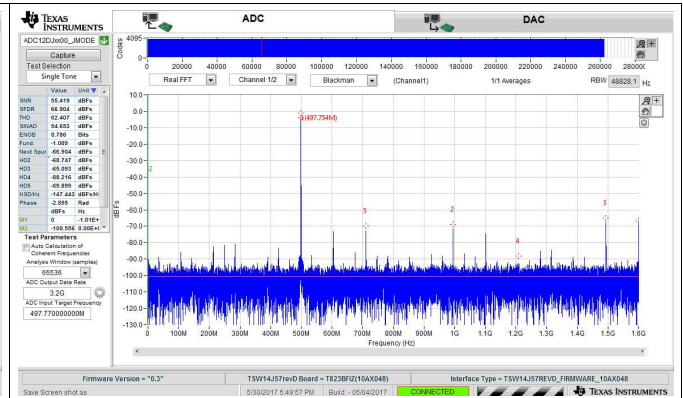
This section demonstrates the use of the ADC12DJ3200 in a reconfigurable oscilloscope. The oscilloscope can operate as a dual-channel oscilloscope running at 2.5 GSPS or can be reconfigured through SPI programming as a single-channel, 5-GSPS oscilloscope. This reconfigurable setup allows users to trade off the number of channels and the sampling rate of the oscilloscope as needed without changing the hardware. Set the input bandwidth to the desired maximum signal bandwidth through the use of an antialiasing, low-pass filter. Digital filtering can then be used to reconfigure the analog bandwidth as required. For instance, the maximum bandwidth can be set to 1 GHz for use during pulsed transient detection and then reconfigured to 100 MHz through digital filtering for low-noise, sine-wave observation. [图 184](#) shows the application block diagram.

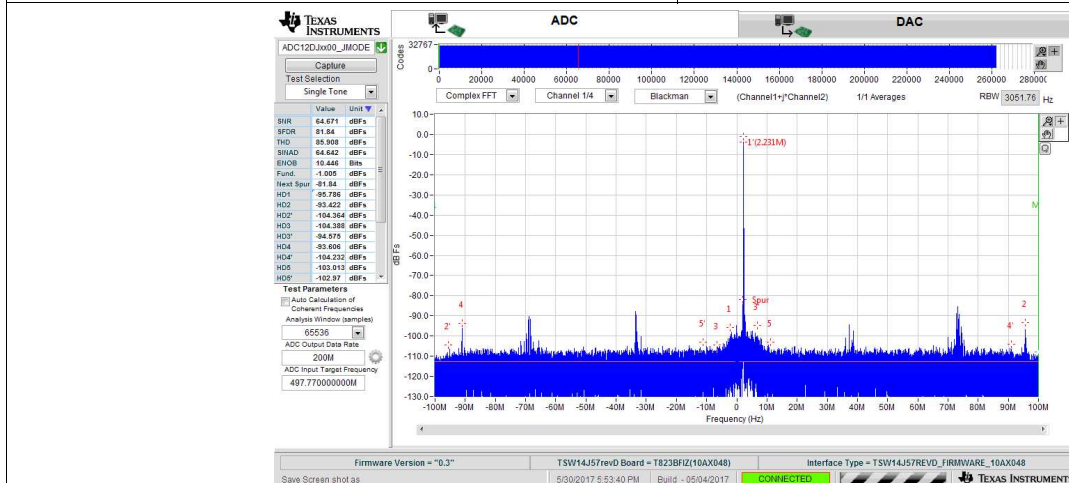
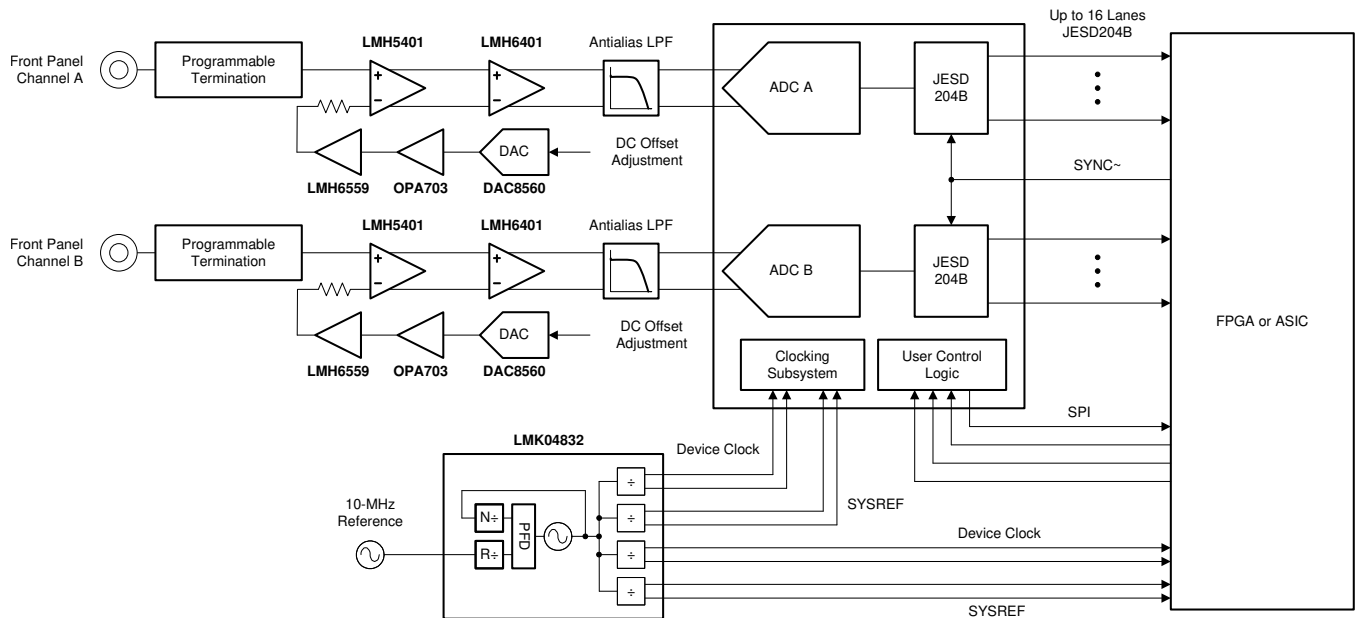

Copyright © 2018, Texas Instruments Incorporated

图 184. Typical Configuration for Reconfigurable Oscilloscope

### 8.2.2.1 Design Requirements

#### 8.2.2.1.1 Input Signal Path

Most oscilloscopes are required to be DC-coupled in order to monitor DC or low-frequency signals. This requirement forces the design to use DC-coupled, fully differential amplifiers to convert from single-ended signaling at the front panel to differential signaling at the ADC. This design uses two differential amplifiers. The first amplifier shown in [图 184](#) is the LMH5401 that converts from single-ended to differential signaling. The LMH5401 interfaces with the front panel through a programmable termination network and has an offset adjustment input. The amplifier has an 8-GHz, gain-bandwidth product that is sufficient to support a 1-GHz bandwidth oscilloscope. A second amplifier, the LMH6401, comes after the LMH5401 to provide a digitally programmable gain control for the oscilloscope. The LMH6401 supports a gain range from  $-6$  dB to 26 dB in 1-dB steps. If gain control is not necessary or is performed in a different location in the signal chain, then this amplifier can be replaced with a second LMH5401 for additional fixed gain or omitted altogether.

The input of the oscilloscope contains a programmable termination block that is not covered in detail here. This block enables the front-panel input termination to be programmed. For instance, many oscilloscopes allow the termination to be programmed as either 50- $\Omega$  or 1-M $\Omega$  to meet the needs of various applications. A 75- $\Omega$  termination can also be desired to support cable infrastructure use cases. This block can also contain an option for DC blocking to remove the DC component of the external signal and therefore pass only AC signals.

A precision DAC is used to configure the offset of the oscilloscope front-end to prevent saturation of the analog signal chain for input signals containing large DC offsets. The [DAC8560](#) is shown in [Figure 184](#) along with signal-conditioning amplifiers [OPA703](#) and [LMH6559](#). The first differential amplifier, LMH5401, is driven by the front panel input circuitry on one input, and the DC offset bias on the second input. The impedance of these driving signals must be matched at DC and over frequency to ensure good even-order harmonic performance in the single-ended to differential conversion operation. The high bandwidth of the LMH6559 allows the device to maintain low impedance over a wide frequency range.

An antialiasing, low-pass filter is positioned at the input of the ADC to limit the bandwidth of the input signal into the ADC. This amplifier also band-limits the front-end noise to prevent aliased noise from degrading the signal-to-noise ratio of the overall system. Design this filter for the maximum input signal bandwidth specified by the oscilloscope. The input bandwidth can then be reconfigured through the use of digital filters in the FPGA or ASIC to limit the oscilloscope input bandwidth to a bandwidth less than the maximum.

#### 8.2.2.1.2 Clocking

The ADC12DJ3200 clock inputs must be AC-coupled to the device to ensure rated performance. The clock source must have extremely low jitter (integrated phase noise) to enable rated performance. Recommended clock synthesizers include the [LMX2594](#), [LMX2592](#), and [LMX2582](#).

The JESD204B data converter system (ADC plus FPGA) requires additional SYSREF and device clocks. The [LMK04832](#), [LMK04828](#), [LMK04826](#), and [LMK04821](#) devices are suitable to generate these clocks. Depending on the ADC clock frequency and jitter requirements, this device can also be used as the system clock synthesizer or as a device clock and SYSREF distribution device when multiple ADC12DJ3200 devices are used in a system.

#### 8.2.2.1.3 ADC12DJ3200

The ADC12DJ3200 is ideally suited for oscilloscope applications. The ability to tradeoff channel count and sampling speed allows designers to build flexible hardware to meet multiple needs. This flexibility saves development time and cost, allows hardware reuse for various projects and enables software upgrade paths for additional functionality. The low code-error rate eliminates concerns about undesired time domain glitches or sparkle codes. This rate makes the ADC12DJ3200 a perfect fit for long-duration transient detection measurements and reduces the probability of false triggers. The input common-mode voltage of 0 V allows the driving amplifiers to use equal split power supplies that center the amplifier output common-mode voltage at 0 V and eliminates the need for common-mode voltage shifting before the ADC inputs. The high input bandwidth of the ADC12DJ3200 simplifies the design of the driving amplifier circuit and antialiasing, low-pass filter. The use of dual-edge sampling (DES) in single-channel mode eliminates the need to change the clock frequency when switching between dual- and single-channel modes and simplifies synchronization by relaxing the setup and hold timing requirements of SYSREF. The  $t_{AD}$  adjust circuit allows the user to time-align the sampling instances of multiple ADC12DJ3200 devices.

### 8.2.2.2 Application Curves

The following application curves demonstrate performance and results only of the ADC. The amplifier front-end is not included in these measurements. The following configurations and measurements are shown in 图 185 to 图 191:

- 12-bit, 5-GSPS, single-channel oscilloscope using JMODE0 (8 lanes at 10 Gbps)
  - Idle-channel noise (no input)
  - 40-MHz, square-wave time domain
  - 200-MHz, sine-wave time domain
  - 200-MHz, sine-wave frequency domain (FFT)
- 12-bit, 2.5-GSPS, dual-channel oscilloscope using JMODE2 (8 lanes at 10 Gbps)
  - Idle-channel noise (no input)
  - 40-MHz, square-wave (channel B) and 200-MHz, sine-wave (channel A) time domain
  - 40-MHz, square-wave (channel B) time domain and 200-MHz, sine-wave (channel A) frequency domain (FFT)



图 185. Idle-Channel Noise (No Input) for 5-GSPS, Single-Channel Oscilloscope



图 186. 40-MHz, Square-Wave Time Domain for 5-GSPS, Single-Channel Oscilloscope

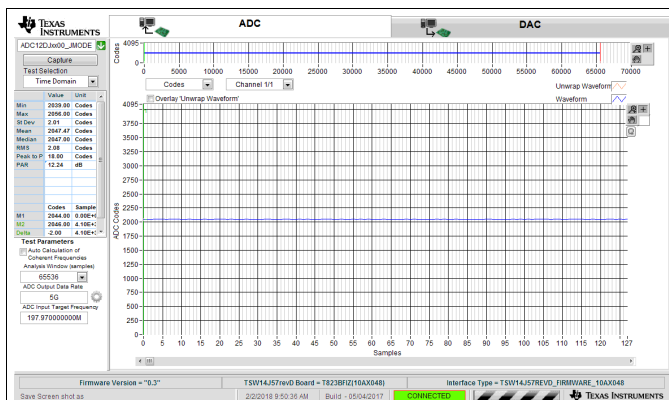

图 187. 200-MHz, Sine-Wave Time Domain for 5-GSPS, Single-Channel Oscilloscope

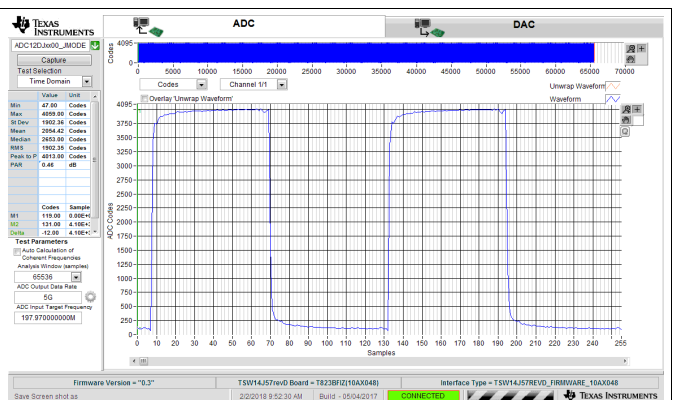

图 188. 200-MHz, Sine-Wave Frequency Domain (FFT) for 5-GSPS, Single-Channel Oscilloscope

ADC12DJ3200

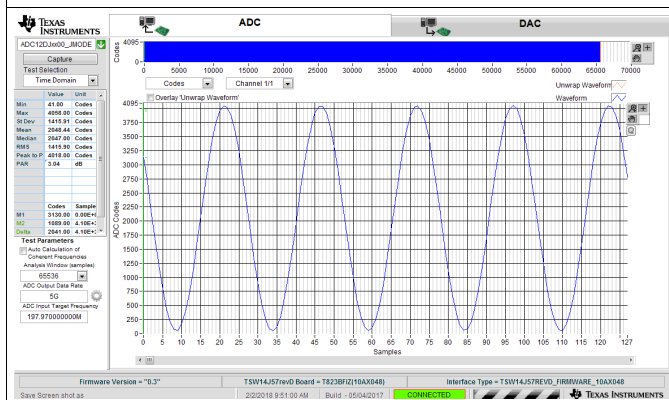
ZHCSGE5A – JUNE 2017 – REVISED APRIL 2020

www.ti.com.cn

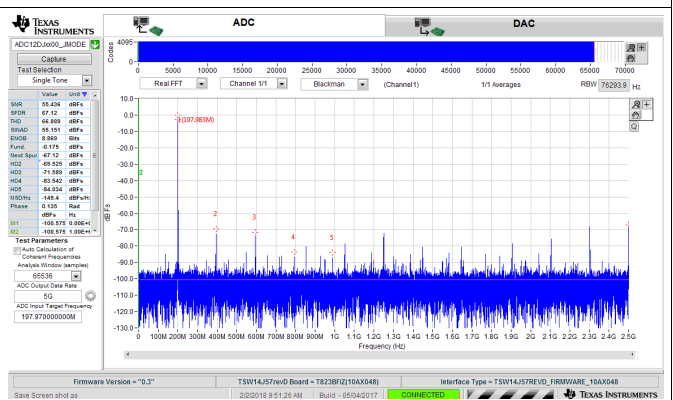

图 189. Idle-Channel Noise (No Input) for 2.5-GSPS, Dual-Channel Oscilloscope



图 190. 200-MHz, Sine-Wave (Channel A) and 40-MHz, Square-Wave (Channel B) Time Domain for 5-GSPS, Single-Channel Oscilloscope



图 191. 200-MHz, Sine-Wave (Channel A) Frequency Domain (FFT) and 40-MHz, Square-Wave (Channel B) Time Domain for 5-GSPS, Single-Channel Oscilloscope

### 8.3 Initialization Set Up

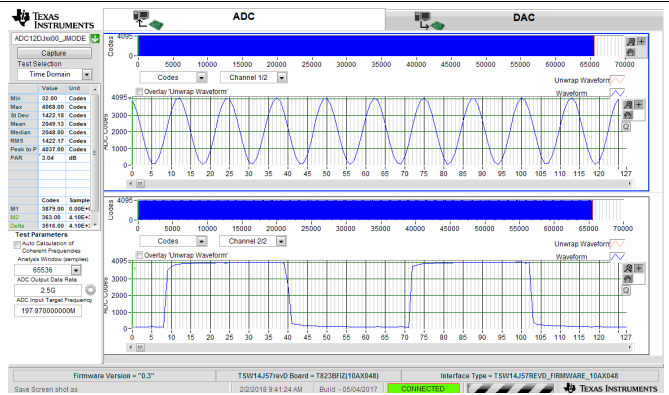
The device and JESD204 interface require a specific startup and alignment sequence. The general order of that sequence is listed in the following steps.

1. Power-up or reset the device.
2. Apply a stable device CLK signal at the desired frequency.
3. Program JESD\_EN = 0 to stop the JESD204B state machine and allow setting changes.
4. Program CAL\_EN = 0 to stop the calibration state machine and allow setting changes.
5. Program the desired JMODE.
6. Program the desired KM1 value.  $KM1 = K - 1$ .
7. Program SYNC\_SEL as needed. Choose SYNCSE or timestamp differential inputs.
8. Configure device calibration settings as desired. Select foreground or background calibration modes and offset calibration as needed.
9. Program CAL\_EN = 1 to enable the calibration state machine.
10. Enable overrange via OVR\_EN and adjust settings if desired.
11. Program JESD\_EN = 1 to re-start the JESD204B state machine and allow the link to restart.
12. The JESD204B interface operates in response to the applied SYNC signal from the receiver.
13. Program CAL\_SOFT\_TRIG = 0.
14. Program CAL\_SOFT\_TRIG = 1 to initiate a calibration.

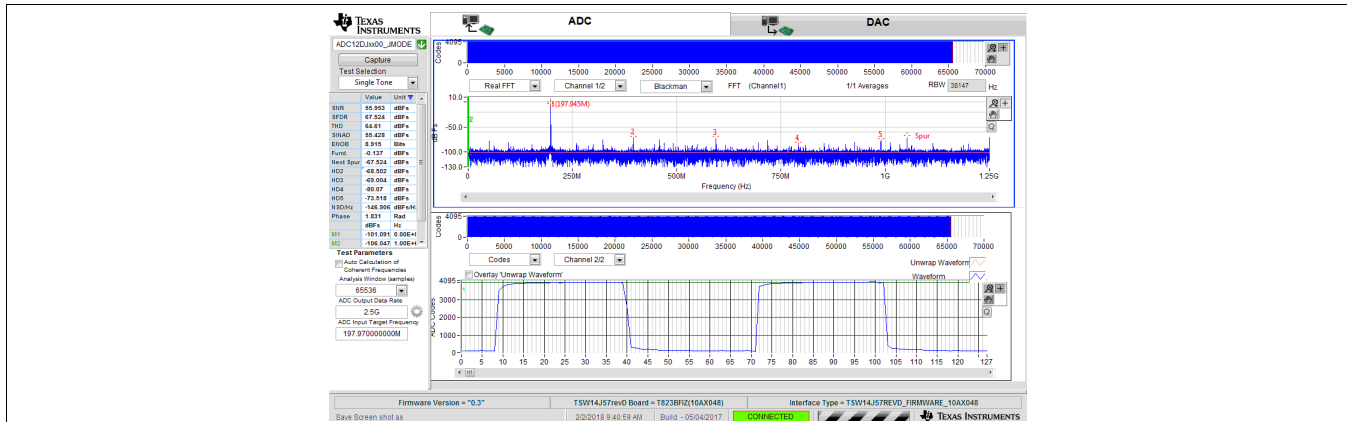
## 9 Power Supply Recommendations

The device requires two different power-supply voltages. 1.9 V DC is required for the VA19 power bus and 1.1 V DC is required for the VA11 and VD11 power buses.

The power-supply voltages must be low noise and provide the needed current to achieve rated device performance.

There are two recommended power supply architectures:

1. Step down using high-efficiency switching converters, followed by a second stage of regulation to provide switching noise reduction and improved voltage accuracy.
2. Directly step down the final ADC supply voltage using high-efficiency switching converters. This approach provides the best efficiency, but care must be taken to ensure switching noise is minimized to prevent degraded ADC performance.

TI WEBENCH® Power Designer can be used to select and design the individual power supply elements needed: see the [WEBENCH® Power Designer](#)

Recommended switching regulators for the first stage include the [TPS62085](#), [TPS82130](#), [TPS62130A](#), and similar devices.

Recommended Low Drop-Out (LDO) linear regulators include the [TPS7A7200](#), [TPS74401](#), and similar devices.

For the switcher only approach, the ripple filter must be designed with a notch frequency that aligns with the switching ripple frequency of the DC-DC converter. Make a note of the switching frequency reported from WEBENCH® and design the EMI filter and capacitor combination to have the notch frequency centered as needed. [Figure 192](#) and [Figure 193](#) illustrate the two approaches.

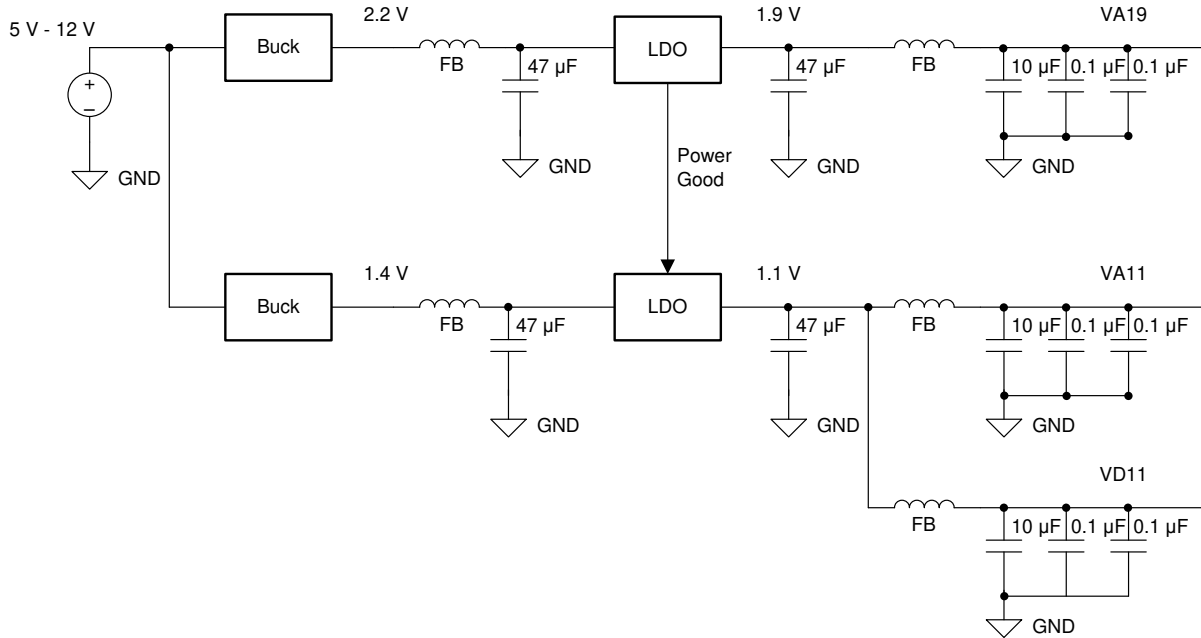

Copyright © 2018, Texas Instruments Incorporated

NOTE: FB = ferrite bead filter.

图 192. LDO Linear Regulator Approach Example

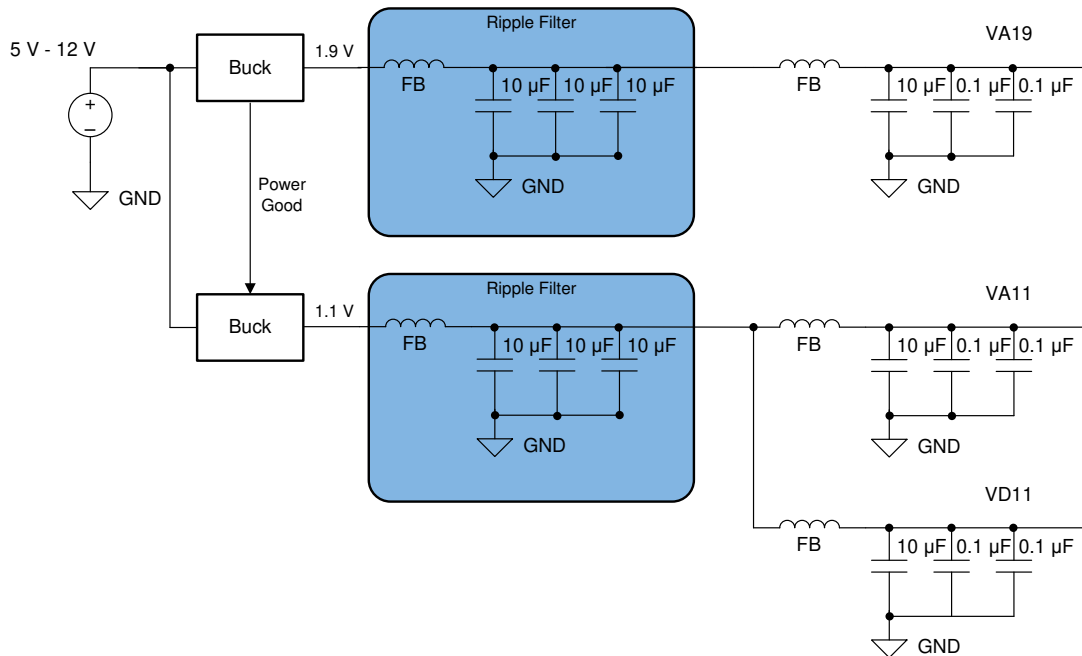

Copyright © 2018, Texas Instruments Incorporated

NOTE: Ripple filter notch frequency to match the  $f_s$  of the buck converter.

NOTE: FB = ferrite bead filter.

图 193. Switcher-Only Approach Example



## 9.1 Power Sequencing

The voltage regulators must be sequenced using the power-good outputs and enable inputs to ensure that the Vx11 regulator is enabled after the VA19 supply is good. Similarly, as soon as the VA19 supply drops out of regulation on power-down, the Vx11 regulator is disabled.

The general requirement for the ADC is that  $VA19 \geq Vx11$  during power-up, operation, and power-down.

TI also recommends that VA11 and VD11 are derived from a common 1.1-V regulator. This recommendation ensures that all 1.1-V blocks are at the same voltage, and no sequencing problems exist between these supplies. Also use ferrite bead filters to isolate any noise on the VA11 and VD11 buses from affecting each other.

## 10 Layout

### 10.1 Layout Guidelines

There are many critical signals that require specific care during board design:

1. Analog input signals
2. CLK and SYSREF
3. JESD204B data outputs:
  1. Lower eight pairs operating at up to 12.8 Gbit per second
  2. Upper eight pairs operating at up to 6.4 Gbit per second
4. Power connections
5. Ground connections

Items 1, 2, and 3 must be routed for excellent signal quality at high frequencies. Use the following general practices:

1. Route using loosely coupled 100- $\Omega$  differential traces. This routing minimizes impact of corners and length-matching serpentes on pair impedance.
2. Provide adequate pair-to-pair spacing to minimize crosstalk.
3. Provide adequate ground plane pour spacing to minimize coupling with the high-speed traces.
4. Use smoothly radiused corners. Avoid 45- or 90-degree bends.
5. Incorporate ground plane cutouts at component landing pads to avoid impedance discontinuities at these locations. Cut-out below the landing pads on one or multiple ground planes to achieve a pad size or stackup height that achieves the needed 50- $\Omega$ , single-ended impedance.
6. Avoid routing traces near irregularities in the reference ground planes. Irregularities include ground plane clearances associated with power and signal vias and through-hole component leads.
7. Provide symmetrically located ground tie vias adjacent to any high-speed signal vias.
8. When high-speed signals must transition to another layer using vias, transition as far through the board as possible (top to bottom is best case) to minimize via stubs on top or bottom of the vias. If layer selection is not flexible, use back-drilled or buried, blind vias to eliminate stubs.

In addition, TI recommends performing signal quality simulations of the critical signal traces before committing to fabrication. Insertion loss, return loss, and time domain reflectometry (TDR) evaluations should be done.

The power and ground connections for the device are also very important. These rules must be followed:

1. Provide low-resistance connection paths to all power and ground pins.
2. Use multiple power layers if necessary to access all pins.
3. Avoid narrow isolated paths that increase connection resistance.
4. Use a signal, ground, or power circuit board stackup to maximum coupling between the ground and power planes.



## 10.2 Layout Example

图 194 到 图 196 提供 examples 的 critical traces routed on the device evaluation module (EVM).



图 194. Top Layer Routing: Analog Inputs, CLK and SYSREF, DA0-3, DB0-3

Layout Example (接下页)

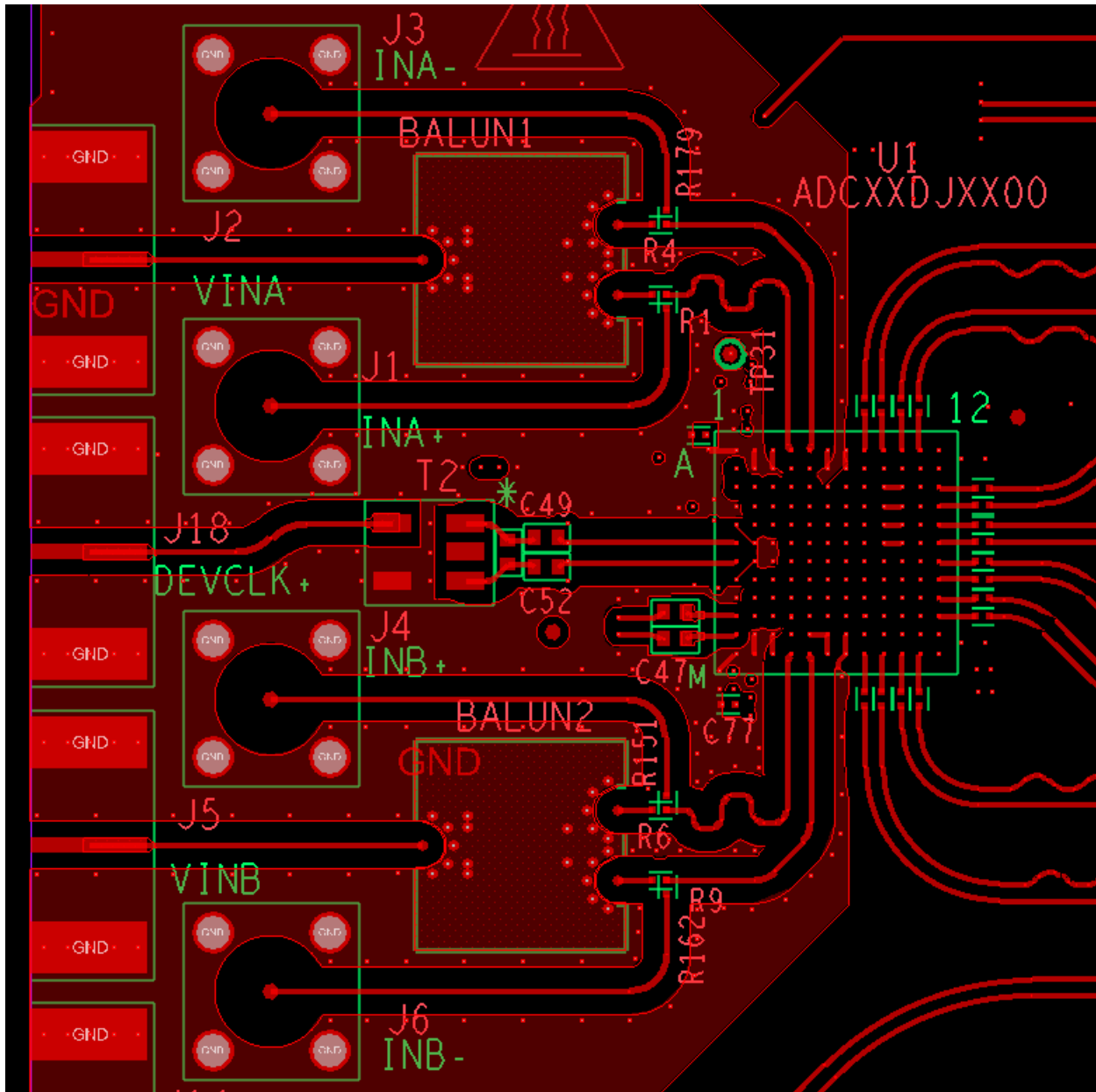

图 195. GND1 Cutouts to Optimize Impedance of Component Pads

Layout Example (接下页)

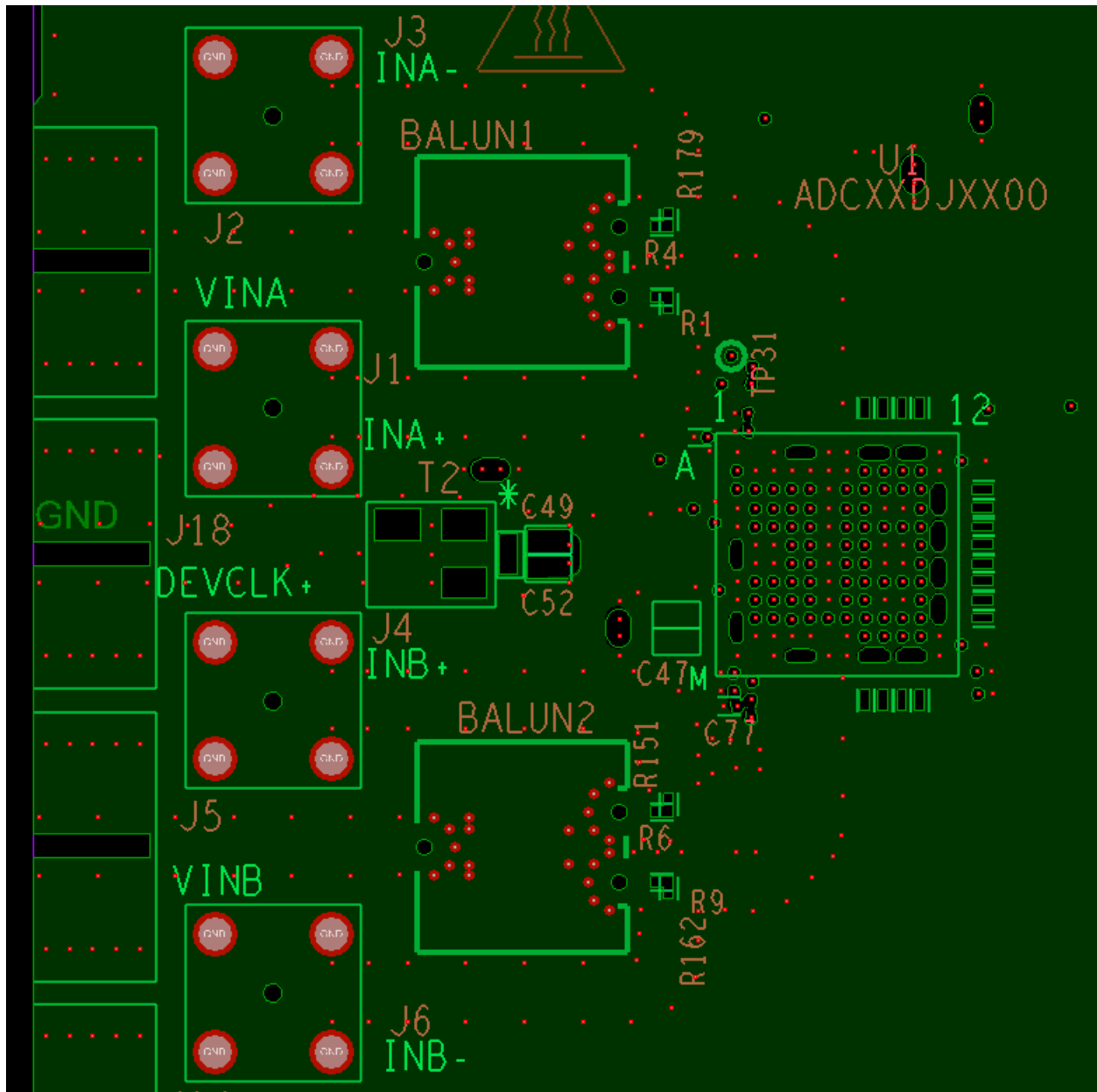

图 196. Bottom Layer Routing: Additional CLK Routing, DA4-7, DB4-7

## 11 器件和文档支持

### 11.1 器件支持

#### 11.1.1 第三方产品免责声明

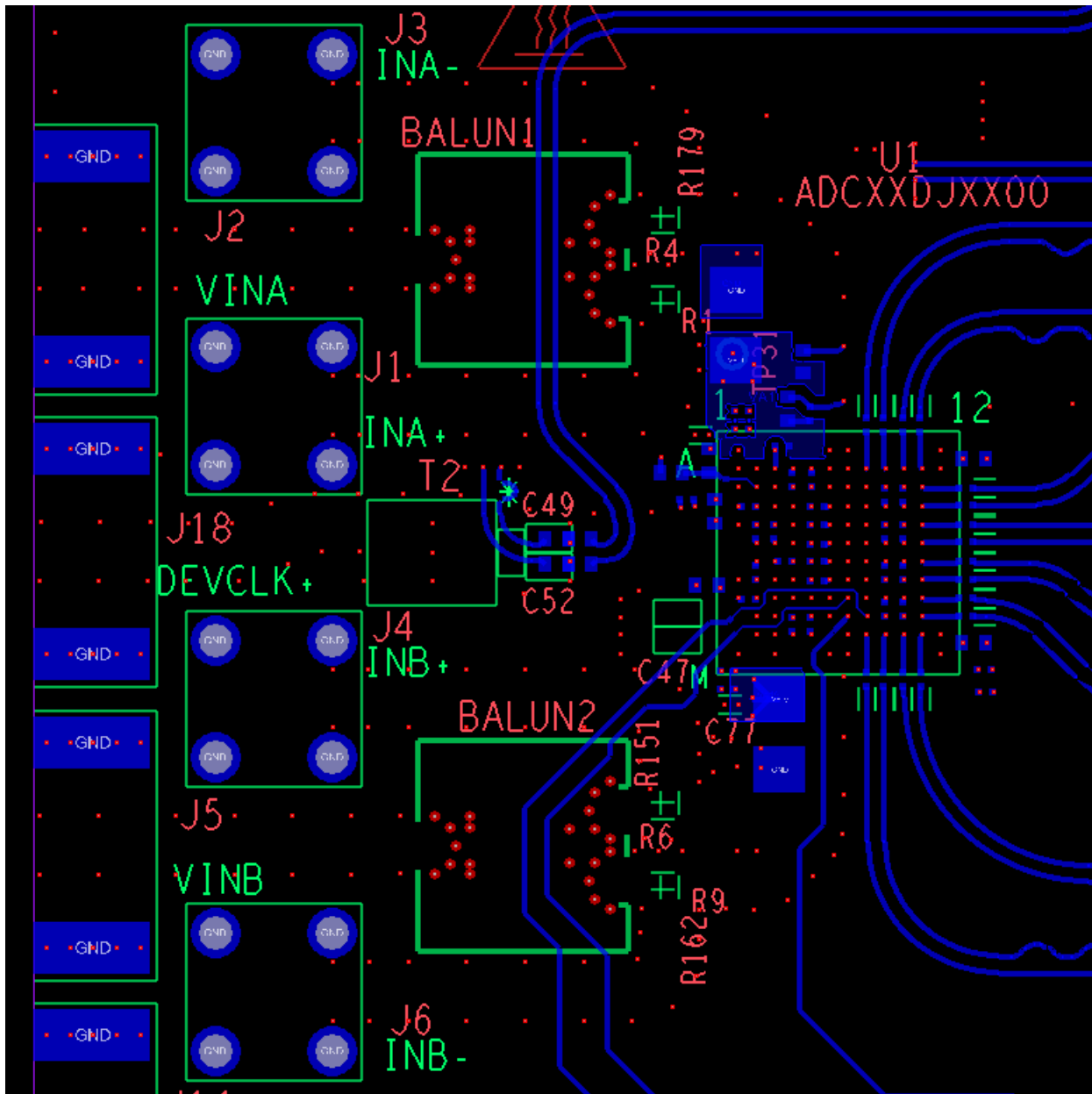
TI 发布的与第三方产品或服务有关的信息，不能构成与此类产品或服务或保修的适用性有关的认可，不能构成此类产品或服务单独或与任何 TI 产品或服务一起的表示或认可。

#### 11.1.2 开发支持

[WEBENCH® 电源设计器](#)

### 11.2 文档支持

#### 11.2.1 相关文档

请参阅如下相关文档：

- 德州仪器 (TI), 《[JESD204B 多器件同步：将要求进行分解](#)》
- 德州仪器 (TI), 《[采用 SMBus 接口和 TruTherm™ 技术的 LM95233 双路远程二极管和本地温度传感器](#)》
- 德州仪器 (TI), 《[提供相位同步功能和 JESD204B 支持的 LMX2594 15GHz 宽带 PLLatinum™ 射频合成器](#)》
- 德州仪器 (TI), 《[具有集成型 VCO 的 LMX2592 高性能宽带 PLLatinum™ 射频合成器](#)》
- 德州仪器 (TI), 《[具有集成型 VCO 的 LMX2582 高性能宽带 PLLatinum™ 射频合成器](#)》
- 德州仪器 (TI), 《[具有双环路 PLL 且符合 JESD204B 标准的 LMK0482x 超低噪声时钟抖动消除器](#)》
- 德州仪器 (TI), 《[采用 2 x 2 QFN 封装且具有断续短路保护功能的 TPS6208x 3A 降压转换器](#)》
- 德州仪器 (TI), 《[具有集成电感器的 TPS82130 17V 输入电压、3A 降压转换器 MicroSiP™ 模块](#)》
- 德州仪器 (TI), 《[采用 3 x 3 QFN 封装的 TPS6213x 3V 至 17V、3A 降压转换器](#)》
- 德州仪器 (TI), 《[TPS7A7200 2A 快速瞬变低压降稳压器](#)》
- 德州仪器 (TI), 《[具有可编程软启动功能的 TPS74401 3.0A 超级 LDO](#)》
- 德州仪器 (TI), 《[采用 ADC12DJ3200 且适用于 L、S、C 和 X 带的直接射频采样雷达接收器参考设计](#)》
- 德州仪器 (TI), 《[ADC12DJ2700 评估模块](#)》用户指南
- 德州仪器 (TI), 《[适用于 DSO、雷达和 5G 无线测试仪的多通道 JESD204B 15GHz 时钟参考设计](#)》
- 德州仪器 (TI), 《[LMH5401 8GHz 低噪声、低功耗全差分放大器](#)》
- 德州仪器 (TI), 《[LMH6401 直流至 4.5GHz、全差分数字可变增益放大器](#)》
- 德州仪器 (TI), 《[具有 2.5V、2ppm/°C 内部基准的 DAC8560 16 位、超低干扰、电压输出数模转换器](#)》
- 德州仪器 (TI), 《[OPA70x CMOS 轨至轨 I/O 运算放大器](#)》
- 德州仪器 (TI), 《[LMH6559 高速闭环缓冲器](#)》
- 德州仪器 (TI), 《[具有双环路 PLL 的 LMK04832 超低噪声且符合 JESD204B 标准的时钟抖动清除器](#)》

#### 11.3 接收文档更新通知

要接收文档更新通知，请导航至 [ti.com.cn](http://ti.com.cn) 上的器件产品文件夹。单击右上角的通知我进行注册，即可每周接收产品信息更改摘要。有关更改的详细信息，请查看任何已修订文档中包含的修订历史记录。

#### 11.4 支持资源

[TI E2E™ support forums](#) are an engineer's go-to source for fast, verified answers and design help — straight from the experts. Search existing answers or ask your own question to get the quick design help you need.

Linked content is provided "AS IS" by the respective contributors. They do not constitute TI specifications and do not necessarily reflect TI's views; see TI's [Terms of Use](#).

#### 11.5 商标

E2E is a trademark of Texas Instruments.

WEBENCH is a registered trademark of Texas Instruments.

All other trademarks are the property of their respective owners.

## 11.6 静电放电警告



这些装置包含有限的内置 ESD 保护。存储或装卸时，应将导线一起截短或将装置放置于导电泡棉中，以防止 MOS 门极遭受静电损伤。

## 11.7 Glossary

[SLYZ022](#) — *TI Glossary*.

This glossary lists and explains terms, acronyms, and definitions.

## 12 机械、封装和可订购信息

以下页面包含机械、封装和可订购信息。这些信息是指定器件的最新可用数据。数据如有变更，恕不另行通知，且不会对此文档进行修订。如需获取此数据表的浏览器版本，请查阅左侧的导航栏。

## PACKAGING INFORMATION

Orderable Device	Status (1)	Package Type	Package Drawing	Pins	Package Qty	Eco Plan (2)	Lead finish/ Ball material (6)	MSL Peak Temp (3)	Op Temp (°C)	Device Marking (4/5)	Samples
ADC12DJ3200AAV	ACTIVE	FCCSP	AAV	144	168	RoHS & Green	SNAGCU	Level-3-260C-168 HR	-40 to 85	ADC12DJ32	<a href="#">Samples</a>
ADC12DJ3200AAVT	ACTIVE	FCCSP	AAV	144	250	RoHS & Green	SNAGCU	Level-3-260C-168 HR	-40 to 85	ADC12DJ32	<a href="#">Samples</a>
ADC12DJ3200ZEG	ACTIVE	FCCSP	ZEG	144	168	Non-RoHS & Green	Call TI	Level-3-235C-168 HR	-40 to 85	ADC12DJ32Z	<a href="#">Samples</a>
ADC12DJ3200ZEGT	ACTIVE	FCCSP	ZEG	144	250	Non-RoHS & Green	Call TI	Level-3-235C-168 HR	-40 to 85	ADC12DJ32Z	<a href="#">Samples</a>

(1) The marketing status values are defined as follows:

**ACTIVE:** Product device recommended for new designs.

**LIFEBUY:** TI has announced that the device will be discontinued, and a lifetime-buy period is in effect.

**NRND:** Not recommended for new designs. Device is in production to support existing customers, but TI does not recommend using this part in a new design.

**PREVIEW:** Device has been announced but is not in production. Samples may or may not be available.

**OBSELETE:** TI has discontinued the production of the device.

(2) **RoHS:** TI defines "RoHS" to mean semiconductor products that are compliant with the current EU RoHS requirements for all 10 RoHS substances, including the requirement that RoHS substance do not exceed 0.1% by weight in homogeneous materials. Where designed to be soldered at high temperatures, "RoHS" products are suitable for use in specified lead-free processes. TI may reference these types of products as "Pb-Free".

**RoHS Exempt:** TI defines "RoHS Exempt" to mean products that contain lead but are compliant with EU RoHS pursuant to a specific EU RoHS exemption.

**Green:** TI defines "Green" to mean the content of Chlorine (Cl) and Bromine (Br) based flame retardants meet JS709B low halogen requirements of <=1000ppm threshold. Antimony trioxide based flame retardants must also meet the <=1000ppm threshold requirement.

(3) MSL, Peak Temp. - The Moisture Sensitivity Level rating according to the JEDEC industry standard classifications, and peak solder temperature.

(4) There may be additional marking, which relates to the logo, the lot trace code information, or the environmental category on the device.

(5) Multiple Device Markings will be inside parentheses. Only one Device Marking contained in parentheses and separated by a "~" will appear on a device. If a line is indented then it is a continuation of the previous line and the two combined represent the entire Device Marking for that device.

(6) Lead finish/Ball material - Orderable Devices may have multiple material finish options. Finish options are separated by a vertical ruled line. Lead finish/Ball material values may wrap to two lines if the finish value exceeds the maximum column width.

**Important Information and Disclaimer:**The information provided on this page represents TI's knowledge and belief as of the date that it is provided. TI bases its knowledge and belief on information provided by third parties, and makes no representation or warranty as to the accuracy of such information. Efforts are underway to better integrate information from third parties. TI has taken and

continues to take reasonable steps to provide representative and accurate information but may not have conducted destructive testing or chemical analysis on incoming materials and chemicals. TI and TI suppliers consider certain information to be proprietary, and thus CAS numbers and other limited information may not be available for release.

In no event shall TI's liability arising out of such information exceed the total purchase price of the TI part(s) at issue in this document sold by TI to Customer on an annual basis.

**TRAY**

Chamfer on Tray corner indicates Pin 1 orientation of packed units.

\*All dimensions are nominal

Device	Package Name	Package Type	Pins	SPQ	Unit array matrix	Max temperature (°C)	L (mm)	W (mm)	K0 (µm)	P1 (mm)	CL (mm)	CW (mm)
ADC12DJ3200AAV	AAV	FCCSP	144	168	8 X 21	150	315	135.9	7620	14.65	11	11.95
ADC12DJ3200ZEG	ZEG	FCCSP	144	168	8 X 21	150	315	135.9	7620	14.65	11	11.95



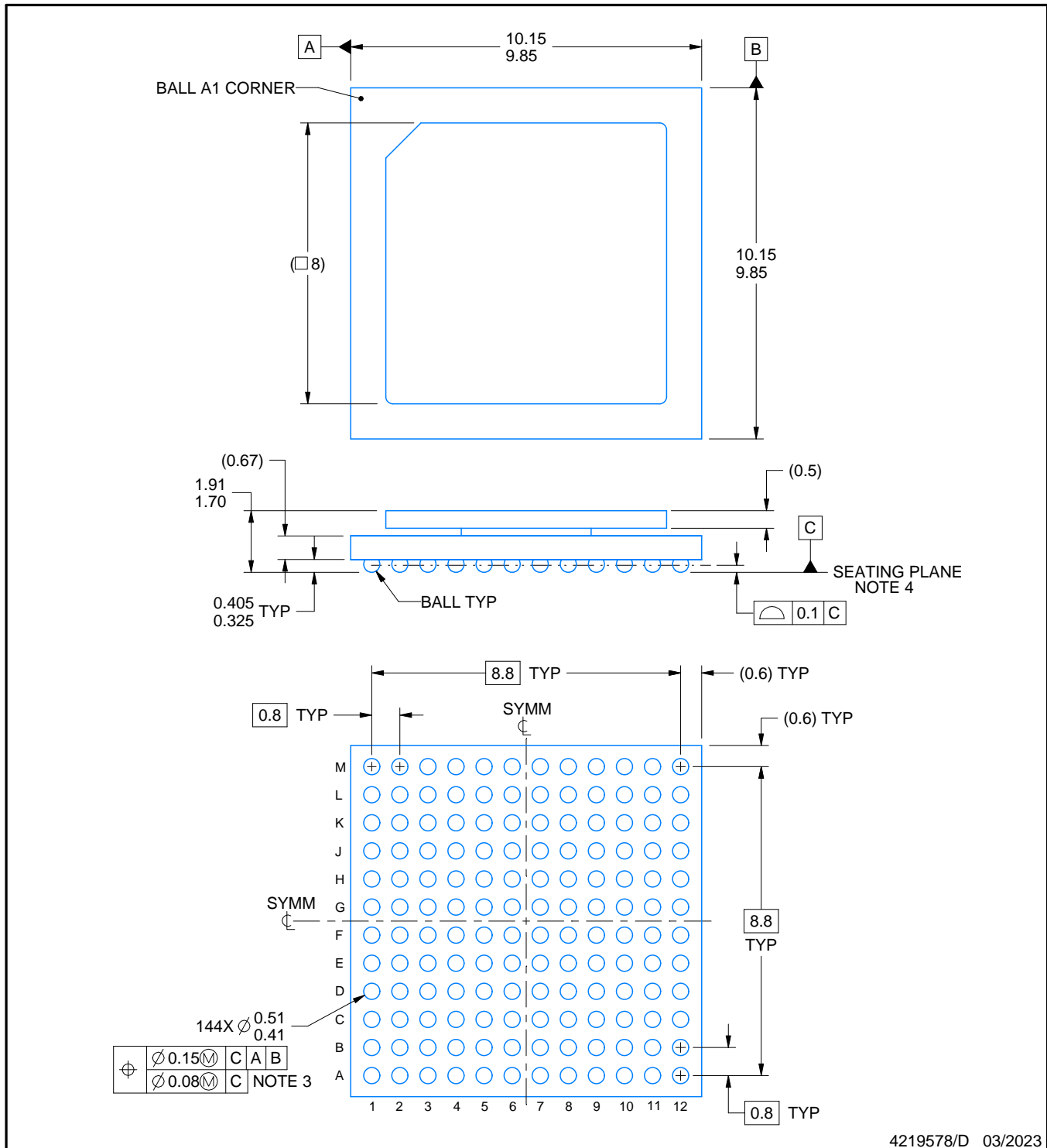
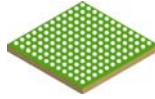

## NOTES:

- All linear dimensions are in millimeters. Any dimensions in parenthesis are for reference only. Dimensioning and tolerancing per ASME Y14.5M.
- This drawing is subject to change without notice.
- Dimension is measured at the maximum solder ball diameter, parallel to primary datum C.
- Primary datum C and seating plane are defined by the spherical crowns of the solder balls.
- The lids are electrically floating (e.g. not tied to GND).

# EXAMPLE BOARD LAYOUT

AAV0144A

FCBGA - 1.91 mm max height

BALL GRID ARRAY

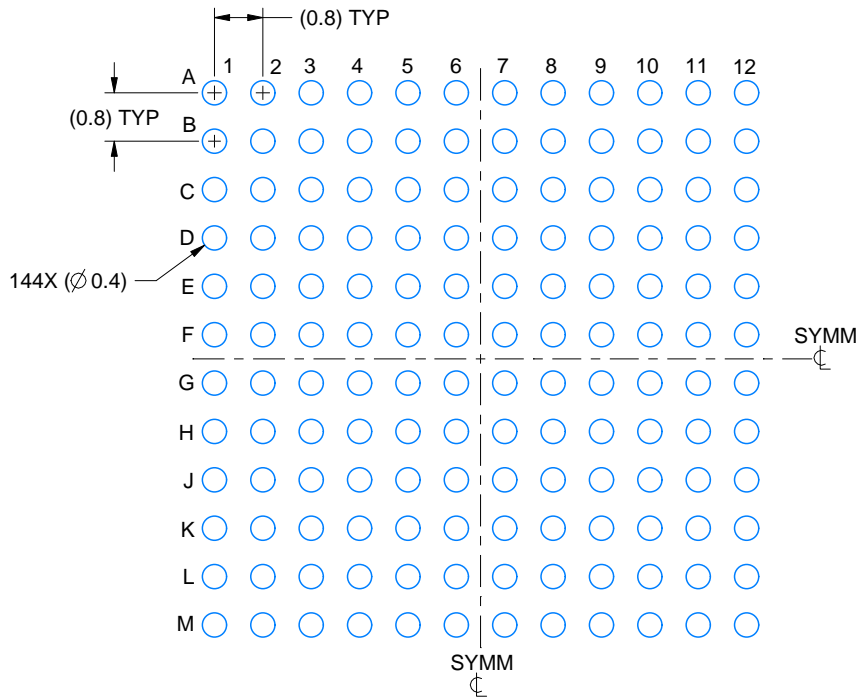

LAND PATTERN EXAMPLE  
EXPOSED METAL SHOWN  
SCALE:8X

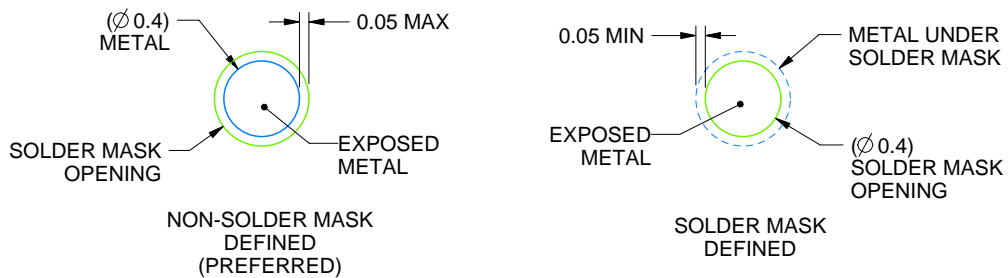

SOLDER MASK DETAILS  
NOT TO SCALE

4219578/D 03/2023

NOTES: (continued)

- Final dimensions may vary due to manufacturing tolerance considerations and also routing constraints. For more information, see Texas Instruments literature number SPRU811 ([www.ti.com/lit/spru811](http://www.ti.com/lit/spru811)).

# EXAMPLE STENCIL DESIGN

AAV0144A

FCBGA - 1.91 mm max height

BALL GRID ARRAY

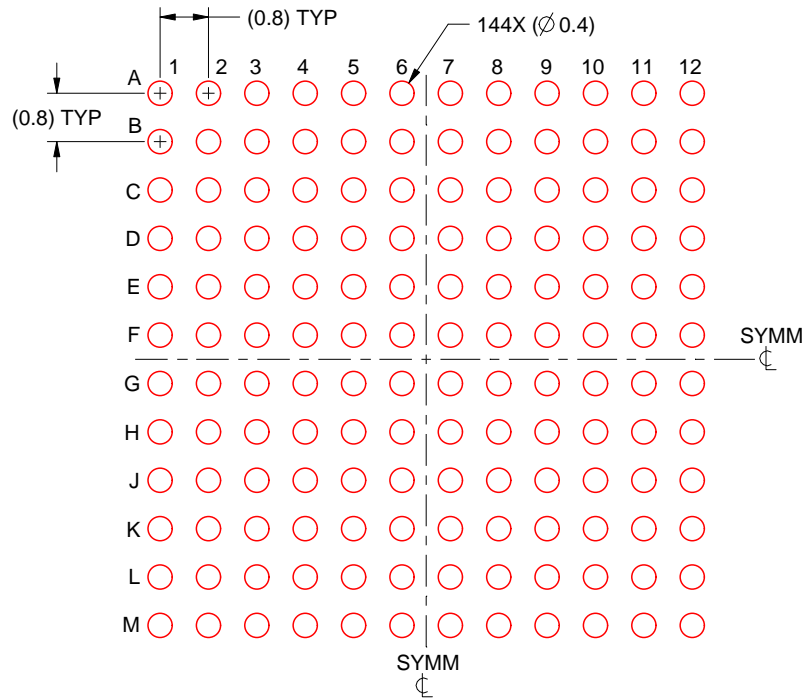

SOLDER PASTE EXAMPLE  
BASED ON 0.15 mm THICK STENCIL  
SCALE:8X

4219578/D 03/2023

NOTES: (continued)

7. Laser cutting apertures with trapezoidal walls and rounded corners may offer better paste release.

## 重要声明和免责声明

TI“按原样”提供技术和可靠性数据（包括数据表）、设计资源（包括参考设计）、应用或其他设计建议、网络工具、安全信息和其他资源，不保证没有瑕疵且不做任何明示或暗示的担保，包括但不限于对适销性、某特定用途方面的适用性或不侵犯任何第三方知识产权的暗示担保。

这些资源可供使用 TI 产品进行设计的熟练开发人员使用。您将自行承担以下全部责任：(1) 针对您的应用选择合适的 TI 产品，(2) 设计、验证并测试您的应用，(3) 确保您的应用满足相应标准以及任何其他功能安全、信息安全、监管或其他要求。

这些资源如有变更，恕不另行通知。TI 授权您仅可将这些资源用于研发本资源所述的 TI 产品的应用。严禁对这些资源进行其他复制或展示。您无权使用任何其他 TI 知识产权或任何第三方知识产权。您应全额赔偿因在这些资源的使用中对 TI 及其代表造成的任何索赔、损害、成本、损失和债务，TI 对此概不负责。

TI 提供的产品受 [TI 的销售条款](#) 或 [ti.com](#) 上其他适用条款/TI 产品随附的其他适用条款的约束。TI 提供这些资源并不会扩展或以其他方式更改 TI 针对 TI 产品发布的适用的担保或担保免责声明。

TI 反对并拒绝您可能提出的任何其他或不同的条款。

邮寄地址：Texas Instruments, Post Office Box 655303, Dallas, Texas 75265

Copyright © 2023，德州仪器 (TI) 公司