

# TPS56339 4.5-V to 24-V Input, 3-A Output Synchronous Step-Down Converter

## 1 Features

- Input Voltage Range: 4.5 V to 24 V
- Output Voltage Range: 0.8 V to 16 V
- Minimum Switching On-Time: 60 ns
- 97% high duty cycle supported
- Integrated 70-m $\Omega$  and 35-m $\Omega$  MOSFETs for 3-A, Continuous Output Current
- Low 3- $\mu$ A Shutdown, 93- $\mu$ A Quiescent Current
- Internal 5-ms Soft-Start
- Fixed 500-kHz switching frequency
- Internal loop compensation for ease of use
- Overcurrent Protection for Both high-side and low-side MOSFETs
- Non-latch UVP and OTSD Protection
- SOT-23 (6) Package

## 2 Applications

- 12-V, 19-V Distributed Power-Bus Supply
- Industry Application
  - Surveillance
  - Appliance
- Consumer Application
  - TV/Monitor
  - Speaker

## 3 Description

The TPS56339 is a 4.5-V to 24-V input voltage range, 3-A synchronous buck converter. The device includes two integrated switching MOSFETs, internal loop compensation and 5-ms internal soft-start to reduce component count.

By integrating the MOSFETs and employing the SOT-23 package, the device achieves the high power density and offers small footprint on PCB.

The TPS56339 can get both fixed switching frequency and fast load transient performance. The internal adaptive zero adjustment eliminate the need for external compensation over a wide output range.

Cycle by cycle current limit in high-side protects the converter in over load condition and is enhanced by a low-side MOSFET freewheeling current limit which prevents current runaway. Hiccup mode protection will be triggered when UVP and OTSD happened.

### Device Information<sup>(1)</sup>

PART NUMBER	PACKAGE	BODY SIZE (NOM)
TPS56339	SOT-23 (6)	1.60 mm x 2.90 mm

(1) For all available packages, see the orderable addendum at the end of the data sheet.

### Simplified Schematic

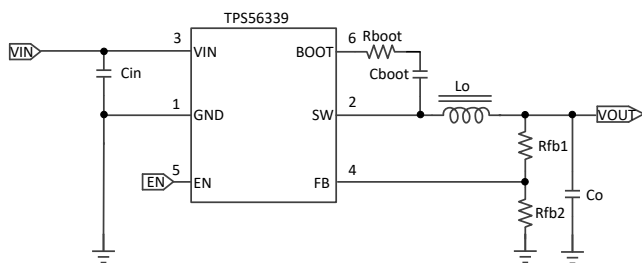

### TPS56339 Efficiency

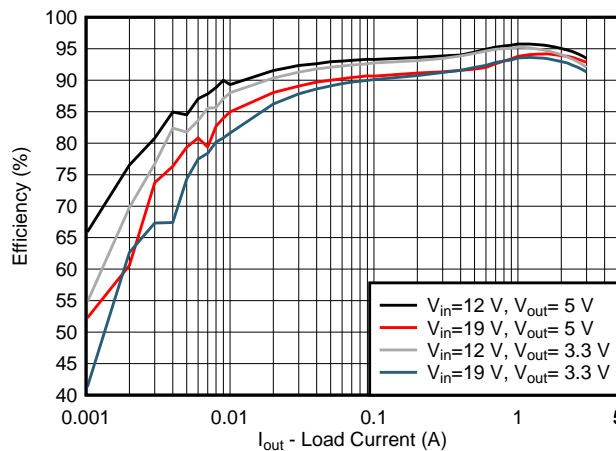

Eff-



An IMPORTANT NOTICE at the end of this data sheet addresses availability, warranty, changes, use in safety-critical applications, intellectual property matters and other important disclaimers. ADVANCE INFORMATION for pre-production products; subject to change without notice.

## Table of Contents

<b>1 Features</b> .....	<a href="#">1</a>	7.3 Feature Description .....	<a href="#">10</a>
<b>2 Applications</b> .....	<a href="#">1</a>	7.4 Device Functional Modes .....	<a href="#">13</a>
<b>3 Description</b> .....	<a href="#">1</a>	<b>8 Application and Implementation</b> .....	<a href="#">14</a>
<b>4 Revision History</b> .....	<a href="#">2</a>	8.1 Application Information .....	<a href="#">14</a>
<b>5 Pin Configuration and Functions</b> .....	<a href="#">3</a>	8.2 Typical Application .....	<a href="#">14</a>
<b>6 Specifications</b> .....	<a href="#">4</a>	<b>9 Power Supply Recommendations</b> .....	<a href="#">20</a>
6.1 Absolute Maximum Ratings .....	<a href="#">4</a>	<b>10 Layout</b> .....	<a href="#">21</a>
6.2 ESD Ratings .....	<a href="#">4</a>	10.1 Layout Guidelines .....	<a href="#">21</a>
6.3 Recommended Operating Conditions .....	<a href="#">4</a>	10.2 Layout Example .....	<a href="#">21</a>
6.4 Thermal Information .....	<a href="#">4</a>	<b>11 Device and Documentation Support</b> .....	<a href="#">22</a>
6.5 Electrical Characteristics .....	<a href="#">5</a>	11.1 Receiving Notification of Documentation Updates .....	<a href="#">22</a>
6.6 Timing Requirements .....	<a href="#">6</a>	11.2 Community Resources .....	<a href="#">22</a>
6.7 Typical Characteristics .....	<a href="#">6</a>	11.3 Trademarks .....	<a href="#">22</a>
<b>7 Detailed Description</b> .....	<a href="#">9</a>	11.4 Electrostatic Discharge Caution .....	<a href="#">22</a>
7.1 Overview .....	<a href="#">9</a>	11.5 Glossary .....	<a href="#">22</a>
7.2 Functional Block Diagram .....	<a href="#">9</a>	<b>12 Mechanical, Packaging, and Orderable Information</b> .....	<a href="#">22</a>

## 4 Revision History

NOTE: Page numbers for previous revisions may differ from page numbers in the current version.

DATE	REVISION	NOTES
November 2018	*	Initial release.

## 5 Pin Configuration and Functions

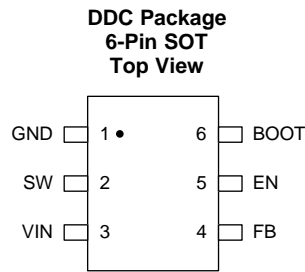

### Pin Functions

PIN		I/O <sup>(1)</sup>	DESCRIPTION
NAME	NO.		
BOOT	6	O	A 20-Ω boot resistor and a bootstrap cap are required between BOOT and SW. The voltage on this cap carries the gate drive voltage for the high-side MOSFET.
EN	5	I	Enable pin. Float to enable. Adjust the input undervoltage lockout with two resistors.
FB	4	I	Converter feedback input. Connect to output voltage with feedback resistor divider.
GND	1	G	Ground pin. Source terminal of low-side MOSFET as well as the ground terminal for controller circuit. Connect sensitive FB to this GND at a single point.
SW	2	O	Switch node connection between high-side MOSFET and low-side MOSFET.
VIN	3	I	Input voltage supply pin. The drain terminal of high-side MOSFET.

(1) I = input, O = output, G = GND

## 6 Specifications

### 6.1 Absolute Maximum Ratings

Over the recommended operating junction temperature range of  $-40^{\circ}\text{C}$  to  $+125^{\circ}\text{C}$  (unless otherwise noted)<sup>(1)</sup>

		MIN	MAX	UNIT
Input voltages	VIN	-0.3	26	V
	EN	-0.3	6	
	BOOT	-0.3	SW+6	
	FB	-0.3	6	
Output voltages	BOOT-SW	-0.3	6	V
	SW	-0.3	26	
	SW (<10 ns transient)	-3	26	
T <sub>J</sub>	Operating junction temperature <sup>(2)</sup>	-40	150	$^{\circ}\text{C}$
T <sub>stg</sub>	Storage temperature	-65	150	$^{\circ}\text{C}$

- (1) Stresses beyond those listed under [Absolute Maximum Ratings](#) may cause permanent damage to the device. These are stress ratings only, which do not imply functional operation of the device at these or any other conditions beyond those indicated under [Recommended Operating Conditions](#). Exposure to absolute-maximum-rated conditions for extended periods may affect device reliability.
- (2) Operating at junction temperatures greater than  $125^{\circ}\text{C}$ , although possible, degrades the lifetime of the device.

### 6.2 ESD Ratings

			VALUE	UNIT
V <sub>(ESD)</sub>	Electrostatic discharge	Human body model (HBM), per ANSI/ESDA/JEDEC JS-001, all pins <sup>(1)</sup>	$\pm 2000$	V
		Charged device model (CDM), per JEDEC specification JESD22-C101, all pins <sup>(2)</sup>	$\pm 500$	

- (1) JEDEC document JEP155 states that 500-V HBM allows safe manufacturing with a standard ESD control process.
- (2) JEDEC document JEP157 states that 250-V CDM allows safe manufacturing with a standard ESD control process.

### 6.3 Recommended Operating Conditions

Over the recommended operating junction temperature range of  $-40^{\circ}\text{C}$  to  $+125^{\circ}\text{C}$  (unless otherwise noted)<sup>(1)</sup>

		MIN	NOM	MAX	UNIT
Input voltage	VIN	4.5		24	V
	EN	-0.1		5.5	V
	FB	-0.1		5.5	V
Output voltage	BOOT-SW	-0.1		5.5	V
	SW	-0.1		24	V
Output Current	I <sub>OUT</sub>	0		3	A
Temperature	Operating junction temperature, T <sub>J</sub>	-40		125	$^{\circ}\text{C}$

- (1) [Recommended Operating Conditions](#) indicate conditions for which the device is intended to be functional, but do not guarantee specific performance limits. For guaranteed specifications, see [Electrical Characteristics](#)

### 6.4 Thermal Information

THERMAL METRIC <sup>(1)</sup>		TPS56339	UNIT
		DDC (SOT23)	
		6 PINS	
R <sub>θJA</sub> <sup>(2) (3)</sup>	Junction-to-ambient thermal resistance	119.1	$^{\circ}\text{C}/\text{W}$
R <sub>θJC(top)</sub>	Junction-to-case (top) thermal resistance	58.1	$^{\circ}\text{C}/\text{W}$

- (1) For more information about traditional and new thermal metrics, see the Semiconductor and IC Package Thermal Metrics application report, [SPRA953](#).
- (2) The value of R<sub>θJA</sub> given in this table is only valid for comparison with other packages and can not be used for design purposes. These values were calculated in accordance with JESD 51-7, and simulated on a specified JEDEC board. They do not represent the performance obtained in an actual application.
- (3) The real R<sub>θJA</sub> on TPS56339EVM is about  $62.5^{\circ}\text{C}/\text{W}$ , test condition: V<sub>IN</sub>=19V, V<sub>OUT</sub>=5V, I<sub>OUT</sub>=3A, T<sub>A</sub>=25 $^{\circ}\text{C}$ .

**Thermal Information (continued)**

THERMAL METRIC <sup>(1)</sup>		TPS56339	UNIT
		DDC (SOT23)	
		6 PINS	
R <sub>θJB</sub>	Junction-to-board thermal resistance	36.7	°C/W
Ψ <sub>JT</sub>	Junction-to-top characterization parameter	9.4	°C/W
Ψ <sub>JB</sub>	Junction-to-board characterization parameter	36.2	°C/W

**6.5 Electrical Characteristics**

Limits apply over the recommended operating junction temperature (T<sub>J</sub>) range of –40°C to +125°C, unless otherwise stated. Minimum and maximum limits are specified through test, design or statistical correlation. Typical values represent the most likely parametric norm at T<sub>J</sub> = 25 °C, and are provided for reference purposes only. Unless otherwise stated, the following conditions apply: V<sub>IN</sub> = 4.5 V to 24 V.

PARAMETER		TEST CONDITIONS	MIN	TYP	MAX	UNIT
<b>POWER SUPPLY (VIN PIN)</b>						
V <sub>IN</sub>	Operation input voltage		4.5		24	V
I <sub>Q</sub>	Non switching quiescent current	First power on with no load, then V <sub>FB</sub> force to 1.2V		93		μA
I <sub>SHDN</sub>	Shutdown supply current	V <sub>EN</sub> =0 V		3		μA
VIN_UVLO	Undervoltage lockout thresholds	VIN Rising threshold	3.9	4.2	4.4	V
VIN_UVLO		VIN Falling threshold	3.5	3.7	3.9	V
<b>ENABLE (EN PIN)</b>						
V <sub>EN_RISE</sub>	Enable threshold	EN rising threshold		1.21	1.28	V
V <sub>EN_FALL</sub>		EN falling threshold	1.08	1.14		V
I <sub>EN_INPUT</sub>	Input current	V <sub>EN</sub> = 1.0V		1		μA
I <sub>EN_HYS</sub>	Hysteresis Current	V <sub>EN</sub> = 1.5V		3		μA
<b>VOLTAGE REFERENCE (FB PIN)</b>						
V <sub>REF</sub>	Reference voltage	T <sub>J</sub> = 25°C	0.794	0.806	0.818	V
		T <sub>J</sub> = -40°C to 125°C	0.786	0.806	0.826	V
<b>INTEGRATED MOSFETS</b>						
R <sub>DS_ON_HS</sub>	High-side MOSFET On-resistance	T <sub>J</sub> = 25°C, V <sub>BOOT-SW</sub> = 5 V		70		mΩ
R <sub>DS_ON_LS</sub>	Low-side MOSFET On-resistance	T <sub>J</sub> = 25°C, V <sub>IN</sub> =12 V		35		mΩ
<b>CURRENT LIMIT</b>						
I <sub>HS_LIMIT</sub>	High-side MOSFET current limit		5.1	5.9	6.9	A
I <sub>LS_LIMIT</sub>	Low-side MOSFET current limit		4	5	6.1	A
<b>OUTPUT UNDERVOLTAGE PROTECTION</b>						
V <sub>UVP</sub>	Output UVP threshold	Hiccup detect (H → L)		62.5		%
V <sub>UVP_HYS</sub>	Hysteresis			5		%
<b>BOOT UVLO</b>						
V <sub>BOOT-SW</sub>	BOOT UVLO threshold			2.2		V
<b>OSCILLATOR</b>						
f <sub>SW</sub>	Switching frequency		450	530	610	KHz
<b>THERMAL SHUTDOWN</b>						
T <sub>SHDN</sub> <sup>(1)</sup>	Thermal Shutdown threshold			160		°C
T <sub>HYS</sub> <sup>(1)</sup>	Hysteresis			20		°C

(1) Not production tested

## 6.6 Timing Requirements

Limits apply over the recommended operating junction temperature ( $T_J$ ) range of  $-40^{\circ}\text{C}$  to  $+125^{\circ}\text{C}$ , unless otherwise stated. Minimum and maximum limits are specified through test, design or statistical correlation. Typical values represent the most likely parametric norm at  $T_J = 25^{\circ}\text{C}$ , and are provided for reference purposes only. Unless otherwise stated, the following conditions apply:  $V_{IN} = 4.5\text{ V}$  to  $24\text{ V}$ .

PARAMETER		TEST CONDITIONS	MIN	TYP	MAX	UNIT
<b>ON TIMER CONTROL</b>						
$T_{ON\_MIN}^{(1)}$	Minimum on time			60		ns
$T_{ON\_MAX}$	Maximum on time			5		$\mu\text{s}$
$T_{OFF\_MIN}$	Minimum off time			115		ns
<b>SOFT START</b>						
$T_{SS}$	Internal soft-start time			5		ms
<b>OUTPUT UNDERVOLTAGE PROTECTION</b>						
$T_{HIC\_WAIT}$	Hiccup on time			120		$\mu\text{s}$
$T_{HIC\_RE}$	Hiccup time before restart			40		ms

(1) Not production tested

## 6.7 Typical Characteristics

$V_{IN} = 12\text{ V}$  (unless otherwise noted)

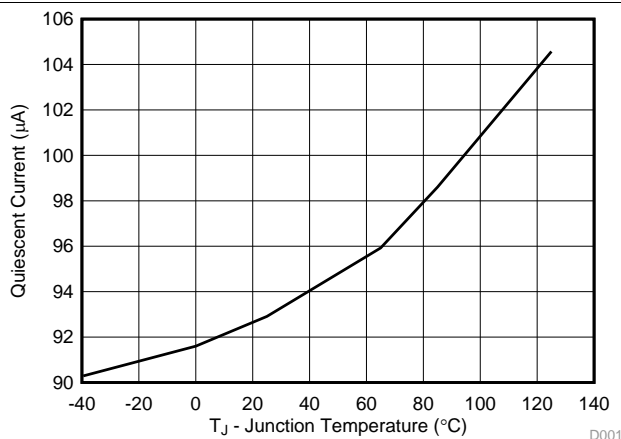

Figure 1. Quiescent Current VS Junction Temperature

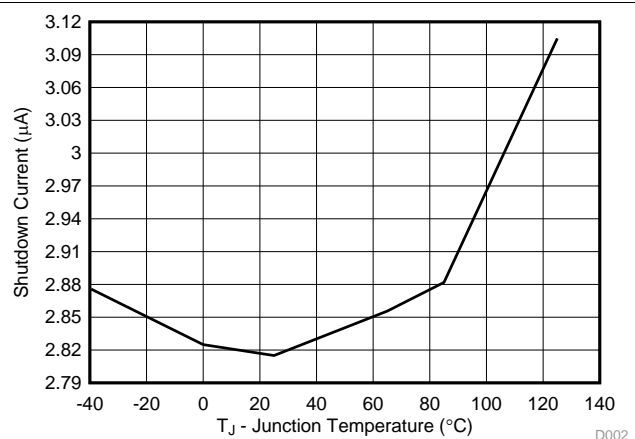

Figure 2. Shutdown Current VS Junction Temperature

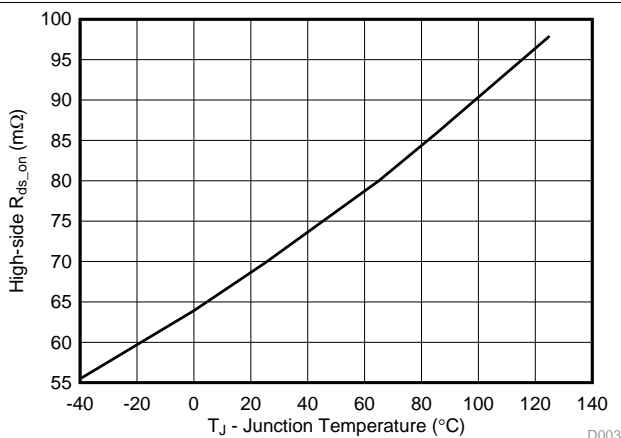

Figure 3. High-side  $R_{ds-on}$  VS Junction Temperature

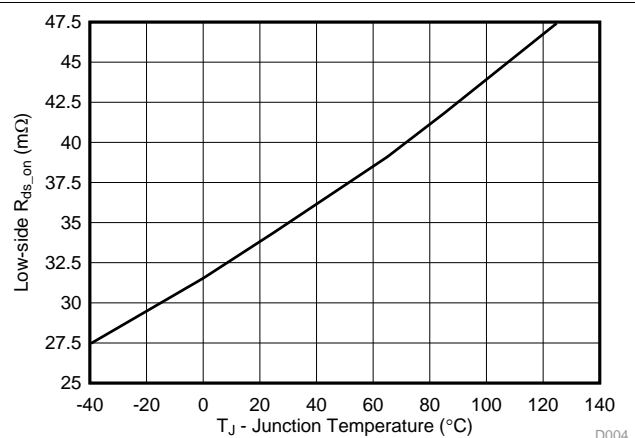

Figure 4. Low-side  $R_{ds-on}$  VS Junction Temperature

Typical Characteristics (continued)

V<sub>IN</sub> = 12 V (unless otherwise noted)

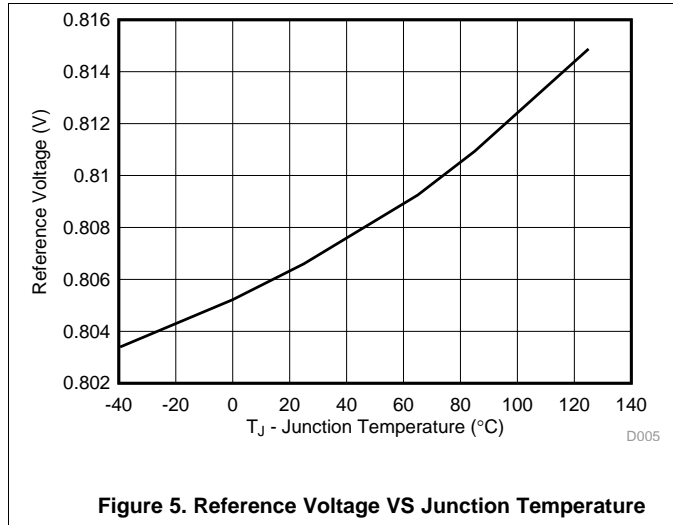

Figure 5. Reference Voltage VS Junction Temperature

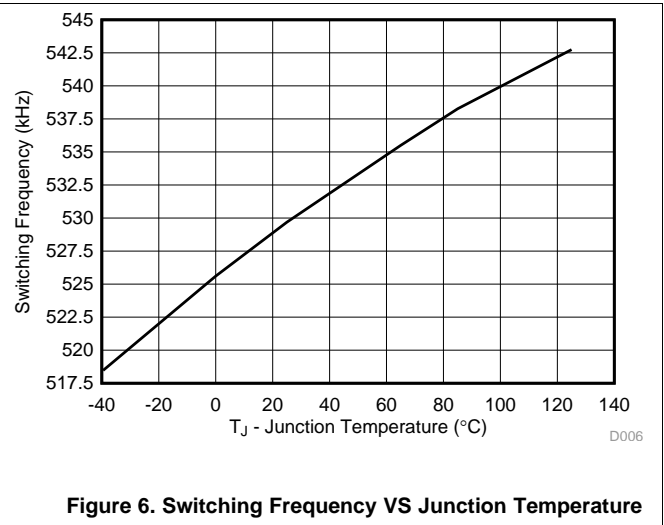

Figure 6. Switching Frequency VS Junction Temperature

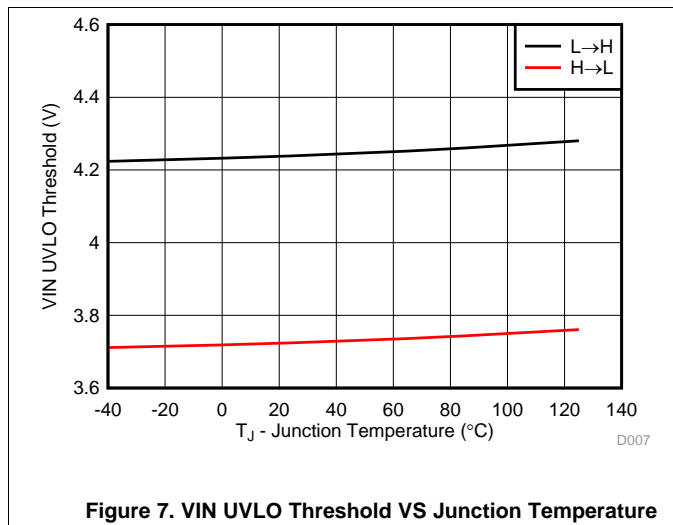

Figure 7. VIN UVLO Threshold VS Junction Temperature

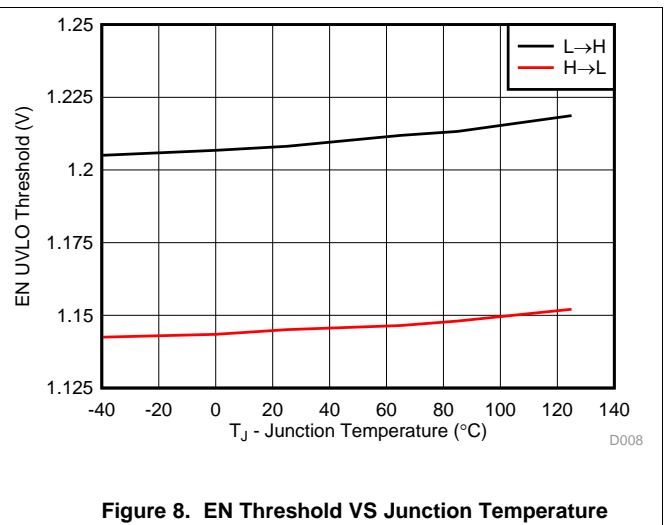

Figure 8. EN Threshold VS Junction Temperature

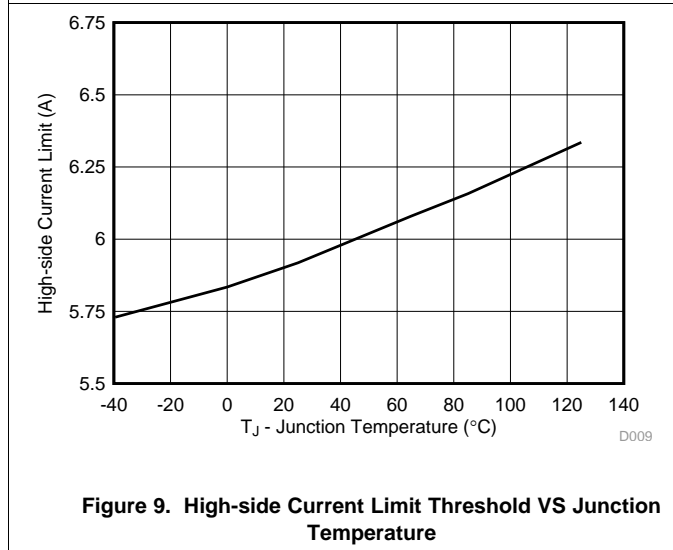

Figure 9. High-side Current Limit Threshold VS Junction Temperature

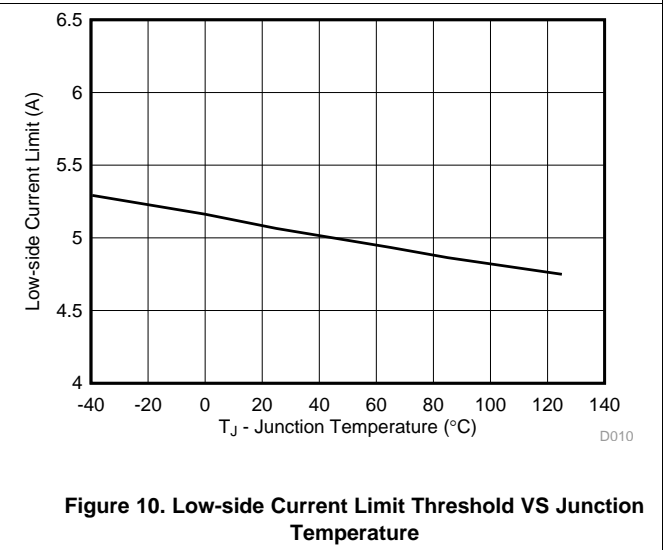
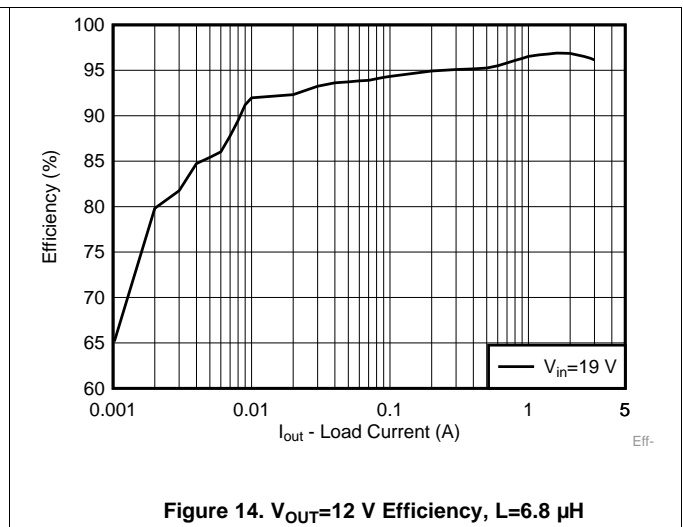
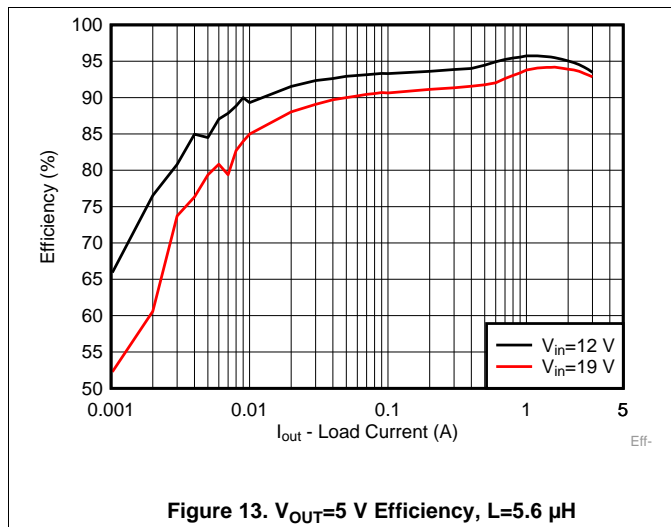
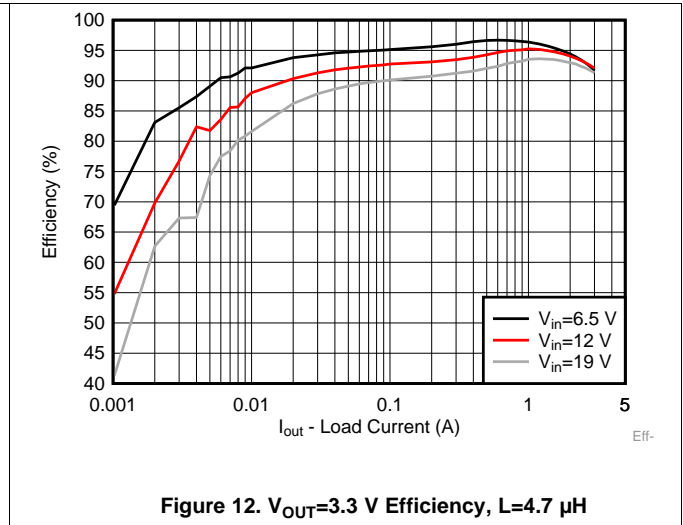
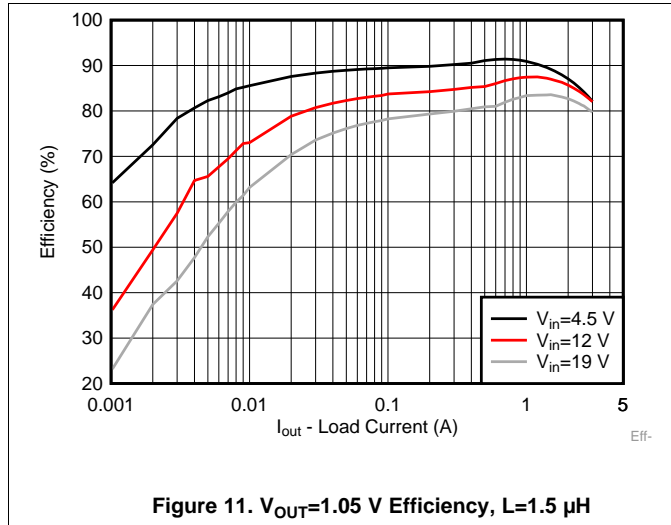

Figure 10. Low-side Current Limit Threshold VS Junction Temperature

ADVANCE INFORMATION

Typical Characteristics (continued)

$V_{IN} = 12\text{ V}$  (unless otherwise noted)



ADVANCE INFORMATION



## 7 Detailed Description

### 7.1 Overview

The TPS56339 is a 24-V, 3-A, synchronous step-down (buck) converter with two integrated n-channel MOSFETs. It could support small output capacitance application with good load transient performance, the switching frequency is fixed at 500 kHz. The optimized internal compensation network minimizes the external component counts and simplifies the control loop design.

The TPS56339 has been designed for safe monotonic start-up into pre-biased loads. The default start-up is when VIN is typically 4.5 V. The EN pin has an internal pull-up current source that can be used to adjust the input voltage undervoltage lockout (UVLO) with two external resistors. In addition, the EN pin can be floating for the device to operate with the internal pull-up current. The total operating current for the device is approximately 93  $\mu$ A when not switching and under no load. When the device is disabled, the supply current is approximately 3  $\mu$ A. The integrated 70-m $\Omega$  high-side MOSFET and 35-m $\Omega$  allow for high efficiency power supply designs with continuous output currents up to 3 A.

The TPS56339 integrates output undervoltage protection. When the regulated output voltage is lower than 62.5% of the nominal voltage due to over current triggered, the undervoltage comparator is activated, 120  $\mu$ s deglitch timer later, both high-side and low-side MOSFET off, the device will into hiccup mode.

The TPS56339 has internal 5-ms soft-start time to minimize inrush currents.

### 7.2 Functional Block Diagram

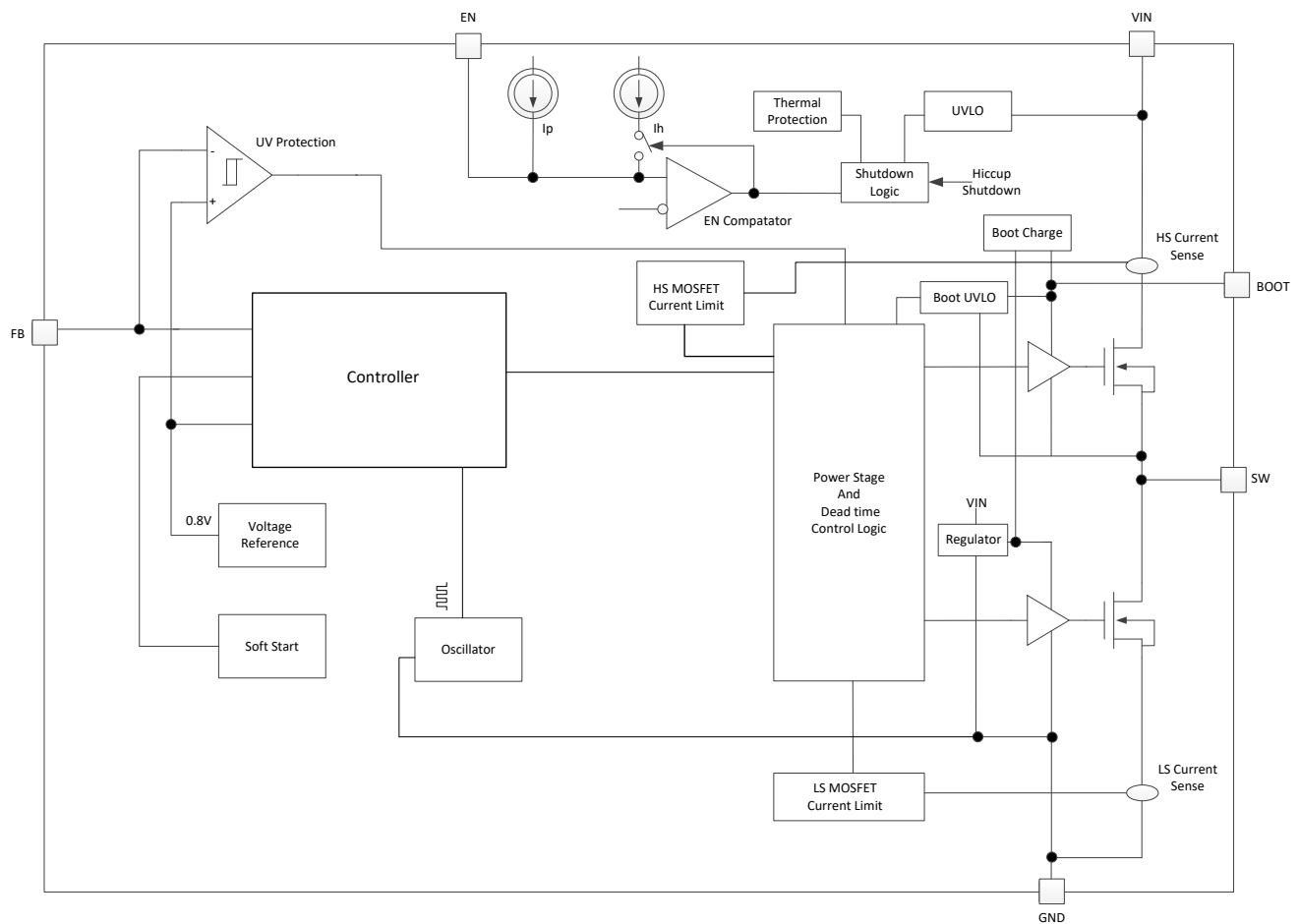

## 7.3 Feature Description

### 7.3.1 Emulated Current Control

The TPS56339 uses an internal oscillator to generate clock to trigger high-side (HS) MOSFET turn on. Once the emulated inductor current ramp up trigger internal reference, the HS MOSFET turns on and the low-side (LS) MOSFET turns off, waiting for the next clock and the LS MOSFET turns off and the HS MOSFET turns on again. So the switching frequency is controlled by the oscillator clock and is fixed that provides ease of filter design to overcome EMI noise. This control architecture includes an internal adaptive ramp generation network that adjust the internal compensation zero, enabling the use of low ESR ceramic output capacitors with fast load transient response and supporting wide output up to 16V.

### 7.3.2 Pulse Frequency Modulation

The TPS56339 is designed with Advanced Eco-mode™ to maintain high light load efficiency. As the output current decreases from heavy load condition, the inductor current is also reduced and eventually comes to point that its rippled valley touches zero level, which is the boundary between continuous conduction and discontinuous conduction modes. The LS MOSFET is turned off when the zero inductor current is detected. As the load current further decreases the converter runs into discontinuous conduction mode. The On-time is kept almost the same as it was in the continuous conduction mode so that it takes longer time to discharge the output capacitor with smaller load current to the level of the reference voltage. This makes the switching frequency lower, proportional to the load current, and keeps the light load efficiency high. The transition point to the light load operation  $I_{OUT(LL)}$  current can be calculated in [Equation 1](#).

$$I_{OUT(LL)} = \frac{0.75^2}{2 \cdot L_1 \cdot f_{sw}} \cdot \frac{(V_{IN} - V_{OUT}) \cdot V_{OUT}}{V_{IN}} \quad (1)$$

### 7.3.3 Enable and Adjusting Undervoltage Lockout

The EN pin provides electrical on and off control of the device. When the EN pin voltage exceeds the threshold voltage, the TPS56339 begins operation. If the EN pin voltage is pulled below the threshold voltage, the regulator stops switching and enters the low-quiescent ( $I_Q$ ) state.

The EN pin has an internal pull-up current source which allows the user to float the EN pin to enable the device. If an application requires control of the EN pin, use open-drain or open-collector output logic to interface with the pin.

The TPS56339 implements internal undervoltage-lockout (UVLO) circuitry on the VIN pin. The device is disabled when the VIN pin voltage falls below the internal VIN UVLO threshold. The internal VIN UVLO threshold has a hysteresis of 510 mV.

If an application requires a higher UVLO threshold on the VIN pin, then the EN pin can be configured as shown in [Figure 15](#). When using the external UVLO function, setting the hysteresis at a value greater than 510 mV is recommended.

The EN pin has a small pull-up current,  $I_p$ , which sets the default state of the pin to enable when no external components are connected. The pull-up current is also used to control the voltage hysteresis for the UVLO function because it increases by  $I_h$  when the EN pin crosses the enable threshold. Use [Equation 2](#), and [Equation 3](#) to calculate the values of R1 and R2 for a specified UVLO threshold. Once R1, R2 settled down, the  $V_{EN}$  voltage can be calculated by [Equation 4](#), which should be lower than 5.5V with max  $V_{IN}$ .

## Feature Description (continued)

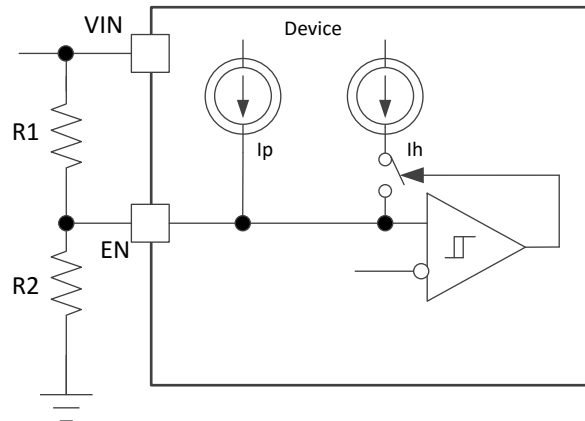

Figure 15. Adjustable VIN Undervoltage Lockout

$$R_1 = \frac{V_{SATART} \frac{V_{EN\_FALL}}{V_{EN\_RISE}} - V_{STOP}}{I_p \left( 1 - \frac{V_{EN\_FALL}}{V_{EN\_RISE}} \right) + I_h} \quad (2)$$

$$R_2 = \frac{R_1 \cdot V_{EN\_FALL}}{V_{STOP} - V_{EN\_FALL} + R_1 \cdot (I_p + I_h)} \quad (3)$$

$$V_{EN} = \frac{R_2 \cdot V_{IN} + R_1 R_2 (I_p + I_h)}{R_1 + R_2} \quad (4)$$

Where

- $I_p = 1 \mu A$
- $I_h = 3 \mu A$
- $V_{EN\_FALL} = 1.14 V$
- $V_{EN\_RISE} = 1.21 V$

### 7.3.4 Soft Start and Pre-Biased Soft Start

The TPS56339 has an internal 5-ms soft-start. When the EN pin becomes high, the internal soft-start function begins ramping up the reference voltage to the PWM comparator.

The TPS56339 has been designed to prevent the LS MOSFET from discharging a pre-biased output. During monotonic pre-biased startup, both HS and LS MOSFET are not allowed to be turned on until the internal soft-start voltage is higher than FB pin voltage. This scheme ensures that the converters ramp up smoothly into regulation point.

### 7.3.5 Voltage Reference

The voltage reference system produces a precise  $\pm 2.5\%$  voltage reference over temperature by scaling the output of a temperature stable bandgap circuit. The typical voltage reference is designed at 0.806 V.

### 7.3.6 Minimum ON-time, Minimum OFF-time and Frequency Foldback at Dropout Conditions

Minimum ON-time,  $T_{ON\_MIN}$ , is the smallest duration of time that the HS MOSFET can be on.  $T_{ON\_MIN}$  is typically 60 ns in the TPS56339. Minimum OFF-time,  $T_{OFF\_MIN}$ , is the smallest duration that the HS MOSFET can be off.  $T_{OFF\_MIN}$  is typically 115 ns in the TPS56339. In CCM operation,  $T_{ON\_MIN}$  and  $T_{OFF\_MIN}$  limit the voltage conversion range given a fixed switching frequency.

## Feature Description (continued)

The minimum duty cycle allowed is:

$$D_{\text{MIN}} = T_{\text{ON\_MIN}} \times f_{\text{SW}} \quad (5)$$

And the maximum duty cycle allowed is:

$$D_{\text{MAX}} = 1 - T_{\text{OFF\_MIN}} \times f_{\text{SW}} \quad (6)$$

In the TPS56339, a frequency foldback scheme is employed to extend the maximum duty cycle when  $T_{\text{OFF\_MIN}}$  is reached. The switching frequency decreases once longer duty cycle is needed under low  $V_{\text{IN}}$  conditions. With the duty increase, the on time will increase, until up to the Maximum ON-time, 5  $\mu\text{s}$ . Wide range of frequency foldback allows the TPS56339 output voltage stay in regulation with a much lower supply voltage  $V_{\text{IN}}$ . This leads to a lower effective dropout voltage.

Given an output voltage, the maximum operation supply voltage can be found by:

$$V_{\text{IN\_MAX}} = \frac{V_{\text{OUT}}}{f_{\text{SW}} \cdot T_{\text{ON\_MIN}}} \quad (7)$$

At lower supply voltage, the switching frequency decreases once  $T_{\text{OFF\_MIN}}$  is triggered. The minimum  $V_{\text{IN}}$  without frequency foldback can be approximated by:

$$V_{\text{IN\_MIN}} = \frac{V_{\text{OUT}}}{(1 - f_{\text{SW}}) \cdot T_{\text{OFF\_MIN}}} \quad (8)$$

Taking considerations of power losses in the system with heavy load operation,  $V_{\text{IN\_MAX}}$  is higher than the result calculated in Equation 7. With frequency foldback,  $V_{\text{IN\_MIN}}$  is lowered by decreased  $f_{\text{SW}}$ , as shown in Figure 16.

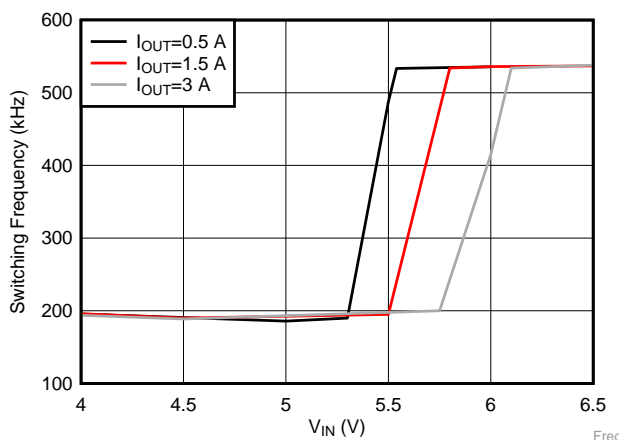

**Figure 16. Frequency Foldback at Dropout ( $V_{\text{OUT}} = 5 \text{ V}$ )**

### 7.3.7 Overcurrent and Undervoltage Protection

The TPS56339 is protected from overcurrent conditions by cycle-by-cycle current limiting on both the peak and valley of the inductor current.

During the on time of the HS MOSFET switch, the inductor current flow through HS FET and increases at a linear rate determined by  $V_{\text{IN}}$ ,  $V_{\text{OUT}}$ , the on-time and the output inductor value. The HS switch current is sensed when the HS is turned on after a set blanking time and is compared with the HS MOSFET current limit every switching cycle. If the cross-limit event detected after the minimum On-time, the HS MOSFET is turned off immediately and the HS MOSFET current is limited by a clamped maximum peak current threshold  $I_{\text{HS\_LIMIT}}$  which is constant.

The current going through LS MOSFET is also sensed and monitored. When the LS switch turns on, the inductor current begins to ramp down. The LS MOSFET is not turned OFF at the end of a switching cycle if its current is above the LS current limit  $I_{\text{LS\_LIMIT}}$ . The LS MOSFET is kept ON for the next cycle so that inductor current keeps ramping down, until the inductor current ramps below the LS current limit  $I_{\text{LS\_LIMIT}}$  and the subsequent switching cycle is coming, then the LS MOSFET is turned OFF, and the HS MOSFET is turned on after a dead time.

## Feature Description (continued)

There are some important considerations for this type of overcurrent protection. The load current is higher than the overcurrent threshold by one half of the peak-to-peak inductor ripple current. Also, when the current is being limited, the output voltage tends to fall as the demanded load current may be higher than the current available from the converter. This may cause the output voltage to fall. When the  $V_{FB}$  voltage falls below the UVP threshold voltage, the UVP comparator detects it. And then, the device will shut down after the UVP delay time (typically 120  $\mu$ s) and re-start after the hiccup time (typically 40 ms). The hiccup mode helps to reduce the device power dissipation under severe overcurrent conditions.

When the over current condition is removed, the output voltage returns to the regulated value.

### 7.3.8 Thermal Shutdown

The internal thermal shutdown circuitry forces the TPS56339 to stop switching if the junction temperature exceeds 160°C typically. When the junction temperature drops below 140°C typically, the internal thermal-hiccup timer begins to count. The device reinitiates the power-up sequence after the built-in thermal-shutdown hiccup time is over.

## 7.4 Device Functional Modes

### 7.4.1 Shutdown Mode

The EN pin provides electrical ON and OFF control for the device. When  $V_{EN}$  is below 1.14 V (typical), the TPS56339 is in shutdown mode with a shutdown current of 3  $\mu$ A (typical). The device also employs VIN UVLO protection. If VIN voltage is below their respective UVLO level, the regulator is turned off.

### 7.4.2 Active Mode

The TPS56339 is in active mode when  $V_{EN}$  is above the precision enable threshold,  $V_{IN}$  is above its respective UVLO level. The simplest way to enable the device is to float the EN pin. This allows self startup when the input voltage is in the operating range 4.5 V to 24 V.

In active mode, depending on the load current, the device is in one of these modes:

1. Continuous conduction mode (CCM) with fixed switching frequency when load current is above half of the peak-to-peak inductor current ripple.
2. Discontinuous conduction mode (DCM) with fixed switching frequency when load current is lower than half of the peak-to-peak inductor current ripple in CCM operation.
3. Eco-mode (Pulse frequency modulation mode, PFM) when switching frequency is decreased at very light load.

### 7.4.3 CCM Mode

CCM operation is employed in the TPS56339 when the minimum switch current is above 0 A. In CCM operation, the frequency of operation is fixed, output voltage ripple is at a minimum in this mode, and the maximum output current of 3 A can be supplied by the device.

### 7.4.4 Eco-mode™ Operation

When the TPS56339 is in the normal CCM operating mode and the switch current falls to 0A, the device begins operating in Eco-mode. Each switching cycle is followed by a period of energy saving sleep time. The sleep time ends when the FB voltage falls below the Eco-mode™ threshold voltage. As the output current decreases, the perceived time between switching pulses increases. The Eco-mode™ operation scheme maintains higher efficiency at light load with a lower switching frequency. If the device works at Eco-mode™ and the load current is light enough to a specific value, it will enter ULQ™ mode with some internal circuits disabled to increase the light load efficiency more high.

## 8 Application and Implementation

### NOTE

Information in the following applications sections is not part of the TI component specification, and TI does not warrant its accuracy or completeness. TI's customers are responsible for determining suitability of components for their purposes. Customers should validate and test their design implementation to confirm system functionality.

### 8.1 Application Information

The TPS56339 is a highly-integrated, synchronous, step-down, DC-DC converter. This device is used to convert a higher DC input voltage to a lower DC output voltage, with a maximum output current of 3 A.

### 8.2 Typical Application

The application schematic of [Figure 17](#) was developed to meet the requirements of the device. This circuit is available as the TPS56339EVM evaluation module. The design procedure is given in this section.

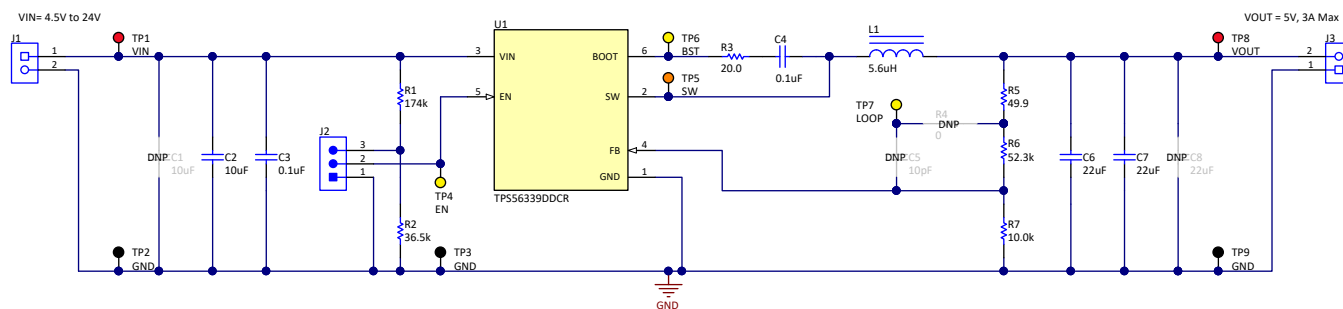

Copyright © 2018, Texas Instruments Incorporated

**Figure 17. TPS56339 5-V, 3-A Reference Design**

## Typical Application (continued)

### 8.2.1 Design Requirements

Table 1 shows the design parameters for this application.

**Table 1. Design Parameters**

PARAMETER	EXAMPLE VALUE
Input voltage	12 V nominal, 4.5 V to 24 V
Output voltage	5 V
Transient response, 2-A load step	$\Delta V_{OUT} = \pm 5\%$
Input ripple voltage	400 mV
Output ripple voltage	30 mV
Output current rating	3 A
Operating frequency	500 kHz

### 8.2.2 Detailed Design Procedure

#### 8.2.2.1 Output Voltage Resistors Selection

The output voltage is set with a resistor divider from the output node to the FB pin. TI recommends using 1% tolerance or better divider resistors. Referring to the application schematic of Figure 17, start with a 10 k $\Omega$  for R7 and use Equation 9 to calculate R6. To improve efficiency at light loads consider using larger value resistors. If the values are too high the regulator is more susceptible to noise and voltage errors from the FB input current are noticeable.

$$R_6 = \frac{V_{OUT} - V_{REF}}{V_{REF}} \cdot R_7 \quad (9)$$

Table 2 shows the recommended components value for common output voltages.

**Table 2. Recommended Component Values**

OUTPUT VOLTAGE (V)	R6 <sup>(1)</sup> (k $\Omega$ )	R7 (k $\Omega$ )	L1 <sup>(2)</sup> ( $\mu$ H)	C <sub>OUT_E</sub> <sup>(3)</sup> ( $\mu$ F)	Min. L1 $\times$ C <sub>OUT_E</sub> ( $\mu$ H $\times$ $\mu$ F)	C5 <sup>(4)</sup> (pF)	R4 (k $\Omega$ )
1.05	3.16	10.0	1.5	41	45		
1.8	12.4	10.0	2.2	36	52		
2.5	21.5	10.0	3.3	32	60		
3.3	31.6	10.0	4.7	28	51		
5	52.3	10.0	5.6	20	46		
12	140	10.0	6.8	12	55	22	51

(1) R6=0  $\Omega$  for V<sub>OUT</sub>=0.8V.

(2) Inductance value is calculated based on V<sub>IN</sub>=19V.

(3) The C<sub>OUT</sub> is the sum of nominal output capacitance, the C<sub>OUT\_E</sub> is the effective value after derating.

(4) For designs with R6 other than recommended value, please adjust C5 such that (C5  $\times$  R6) is unchanged and adjust R7 such that (R6 / R7) is unchanged.

#### 8.2.2.2 Output Filter Selection

Two components must be selected for the output filter, the output inductor L1 and C<sub>OUT</sub>.

The LC filter used as the output filter has double pole at:

$$f_p = \frac{1}{2\pi\sqrt{L_1 \cdot C_{OUT\_E}}} \quad (10)$$

At low frequencies, the overall loop gain is set by the output set-point resistor divider network and the internal gain of the device. The low frequency phase is 180°. At the output filter pole frequency, the gain rolls off at a –40 dB per decade rate and the phase drops rapidly. A high frequency zero introduced by internal circuit that reduces the gain roll off to –20 dB per decade and increases the phase to 90° one decade above the zero frequency. The inductor and capacitor for the output filter must be selected so that the double pole of Equation 10 is located below the high frequency zero but close enough that the phase boost provided by the high frequency zero provides adequate phase margin for a stable circuit. To meet this requirement, make sure that the  $L_1 \cdot C_{OUT\_E}$  value meets the Min  $L_1 \cdot C_{OUT\_E}$  value recommended in Table 2.

To calculate the value of the output inductor, use Equation 11.  $K_{IND}$  is a coefficient that represents the amount of inductor ripple current relative to the maximum output current. The inductor ripple current is filtered by the output capacitor. Therefore, choosing high inductor ripple currents impact the selection of the output capacitor because the output capacitor must have a ripple current rating equal to or greater than the inductor ripple current. In general, the inductor ripple value is at the discretion of the designer. For this part, TI recommends the range of  $K_{IND}$  from 30% to 50%.

$$L_{MIN} = \frac{V_{OUT}}{V_{IN\_MAX}} \cdot \frac{V_{IN\_MAX} - V_{OUT}}{K_{IND} \cdot I_{OUT} \cdot f_{SW}} \quad (11)$$

For this design example, use  $K_{IND} = 50\%$  and the inductor value is calculated to be 5.28  $\mu\text{H}$ . For this design, a nearest standard value was chosen: 5.6  $\mu\text{H}$ . For the output filter inductor, it is important that the RMS current and saturation current ratings not be exceeded. The RMS and peak inductor current can be found from Equation 13 and Equation 14. The inductor peak-to-peak ripple current, peak current and RMS current are calculated using Equation 12, Equation 13, and Equation 14.

$$I_{RIPPLE} = \frac{V_{OUT}}{V_{IN\_MAX}} \cdot \frac{V_{IN\_MAX} - V_{OUT}}{L_1 \cdot f_{SW}} \quad (12)$$

$$I_{LPEAK} = I_{OUT} + \frac{I_{RIPPLE}}{2} \quad (13)$$

$$I_{LRMS} = \sqrt{I_{OUT}^2 + \frac{1}{12} I_{RIPPLE}^2} \quad (14)$$

For this design example, the calculated peak current is 4 A and the calculated RMS current is 3.03 A. The chosen inductor is a Vishay-Dale IHLP3232DZER5R6M11 5.6  $\mu\text{H}$ . It has a saturation current rating of 7.6 A and a RMS current rating of 7.4 A.

The current flowing through the inductor is the inductor ripple current plus the output current. During power up, faults or transient load conditions, the inductor current can increase above the calculated peak inductor current level calculated above. In transient conditions, the inductor current can increase up to the switch current limit of the device. For this reason, the most conservative approach is to specify an inductor with a saturation current rating equal to or greater than the switch current limit rather than the peak inductor current.

The capacitor value and ESR determines the amount of output voltage ripple. The TPS56339 is intended for use with ceramic or other low ESR capacitors. Recommended values range from 20  $\mu\text{F}$  to 88  $\mu\text{F}$ . Use Equation 15 to determine the required RMS current rating for the output capacitor.

$$I_{CORMS} = \frac{V_{OUT} \cdot (V_{IN\_MAX} - V_{OUT})}{\sqrt{12} \cdot V_{IN\_MAX} \cdot L_1 \cdot f_{SW}} \quad (15)$$

For this design two Murata GRM32ER71E226KE15L 22- $\mu\text{F}$  output capacitors are used. The typical ESR is 2 m $\Omega$  for each. The calculated RMS current is 0.408 A and each output capacitor is rated for 4 A.



### 8.2.2.3 Input Capacitor Selection

The TPS56339 requires an input decoupling capacitor and a bulk capacitor is needed depending on the application. TI recommends a ceramic capacitor over 10 μF for the decoupling capacitor. An additional 0.1-μF capacitor (C3) from VIN pin to ground is recommended to provide additional high frequency filtering. The capacitor voltage rating needs to be greater than the maximum input voltage. The capacitor must also have a ripple current rating greater than the maximum input current ripple of the TPS56339. The input ripple current can be calculated using Equation 16.

$$I_{CIRMS} = I_{OUT} \cdot \sqrt{\frac{V_{OUT}}{V_{IN\_MIN}} \cdot \frac{V_{IN\_MIN} - V_{OUT}}{V_{IN\_MIN}}} \tag{16}$$

The value of a ceramic capacitor varies significantly over temperature and the amount of DC bias applied to the capacitor. The capacitance variations due to temperature can be minimized by selecting a dielectric material that is stable over temperature. X5R and X7R ceramic dielectrics are usually selected for power regulator capacitors because they have a high capacitance to volume ratio and are fairly stable over temperature. The output capacitor must also be selected with the DC bias taken into account. The capacitance value of a capacitor decreases as the DC bias across a capacitor increases. For this example design, a ceramic capacitor with at least a 35-V voltage rating is required to support the maximum input voltage. For this example, one 10-μF, 35-V capacitors has been selected. The input capacitance value determines the input ripple voltage of the regulator. The input voltage ripple can be calculated using Equation 17. Using the design example values,  $I_{OUT\_MAX} = 3$  A,  $C_{IN} = 10$  μF,  $f_{SW} = 500$  kHz, yields an input voltage ripple of 150 mV and a RMS input ripple current of 2.95 A.

$$\Delta V_{IN} = \frac{I_{OUT\_MAX} \cdot 0.25}{C_{IN} \cdot f_{SW}} + (I_{OUT\_MAX} \cdot R_{ESR\_MAX}) \tag{17}$$

Where

- $R_{ESR\_MAX}$  is the maximum series resistance of the input capacitor

### 8.2.2.4 Bootstrap Capacitor Selection

A 0.1-μF ceramic capacitor must be connected between the BOOT to SW pin for proper operation. TI recommends to use a ceramic capacitor. In addition, TI recommends in series one boot resistor to make the device more robust, so at least a 20-Ω R3 must be connected between BOOT to bootstrap capacitor, C4.

### 8.2.3 Application Curves

$V_{IN} = 12$  V,  $L_1 = 5.6$  μH,  $C_{OUT} = 44$  μF,  $T_A = 25$  °C. (unless otherwise noted)

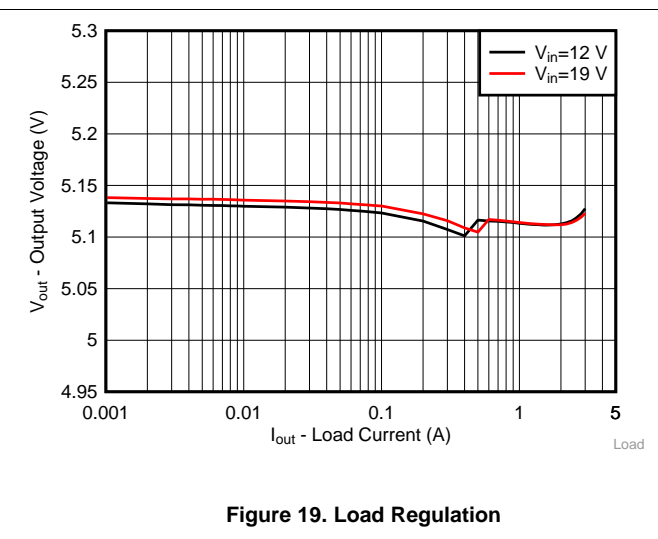
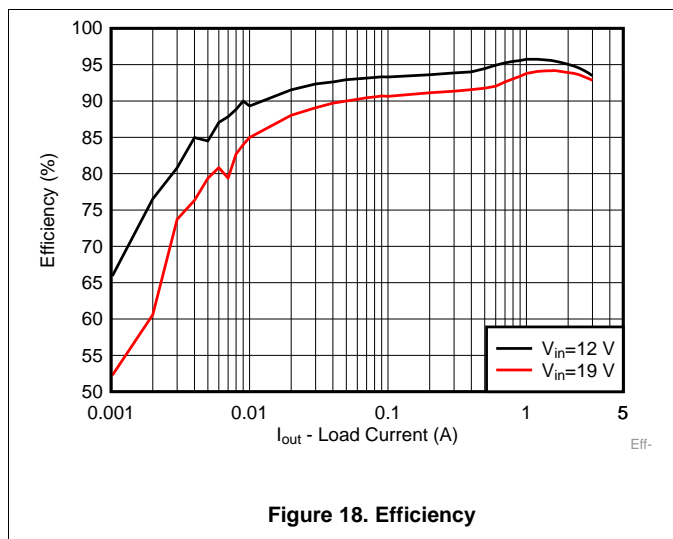

$V_{IN} = 12\text{ V}$ ,  $L_1 = 5.6\ \mu\text{H}$ ,  $C_{OUT} = 44\ \mu\text{F}$ ,  $T_A = 25\ ^\circ\text{C}$ . (unless otherwise noted)

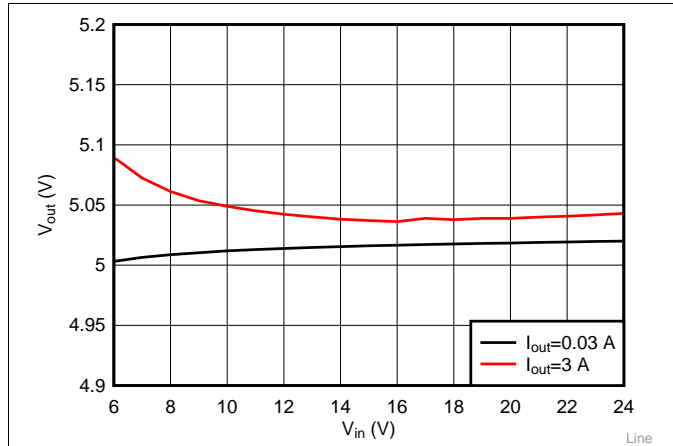

Figure 20. Line Regulation

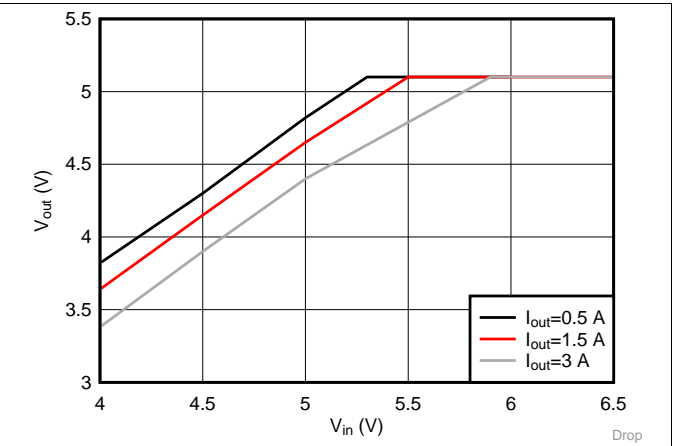

Figure 21. Dropout Curve

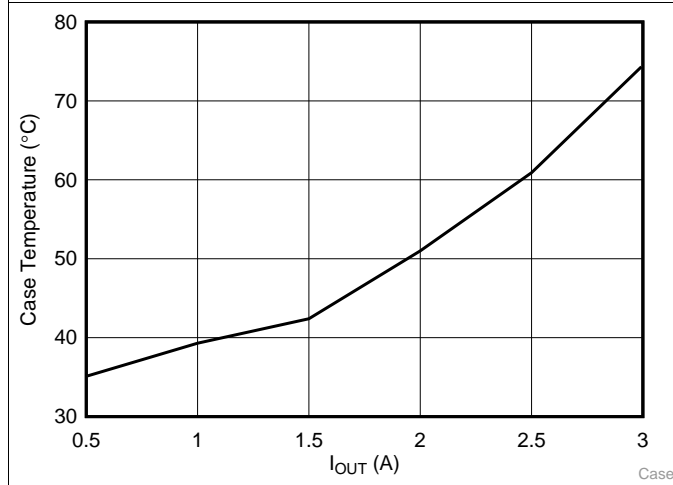

Figure 22. Case Temperature Rise vs Load Current

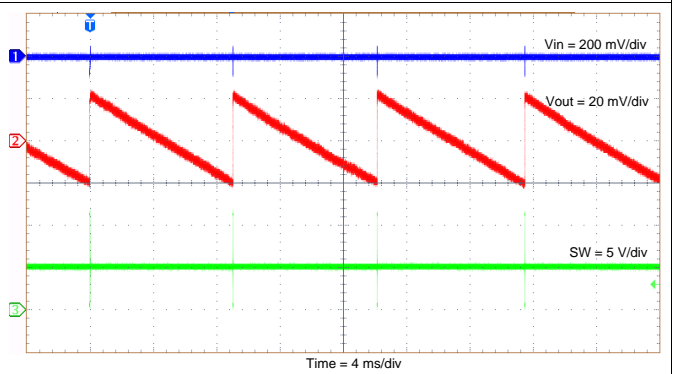

Figure 23. Steady State Waveforms, No Load

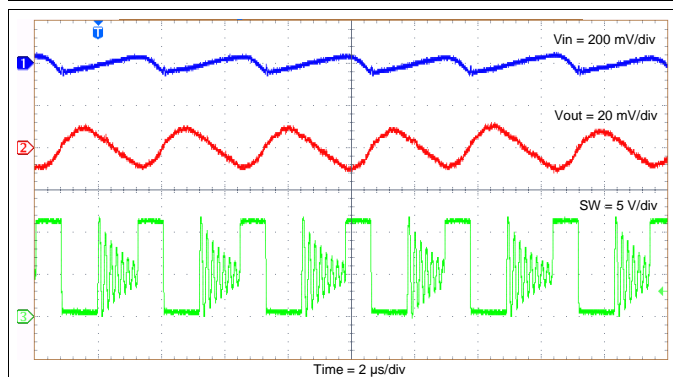

Figure 24. Steady State Waveforms,  $I_{OUT} = 0.3\text{ A}$

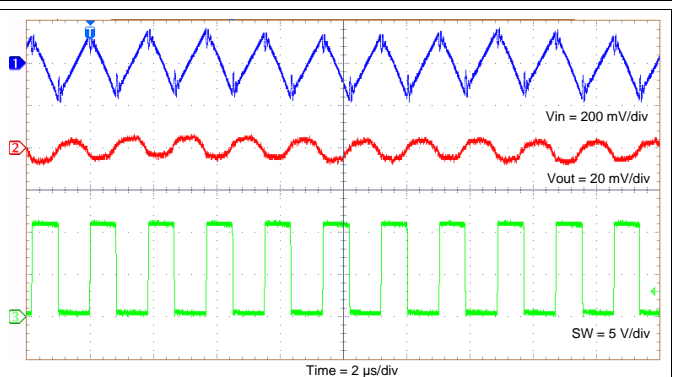

Figure 25. Steady State Waveforms,  $I_{OUT} = 3\text{ A}$

$V_{IN} = 12\text{ V}$ ,  $L_1 = 5.6\ \mu\text{H}$ ,  $C_{OUT} = 44\ \mu\text{F}$ ,  $T_A = 25\ ^\circ\text{C}$ . (unless otherwise noted)

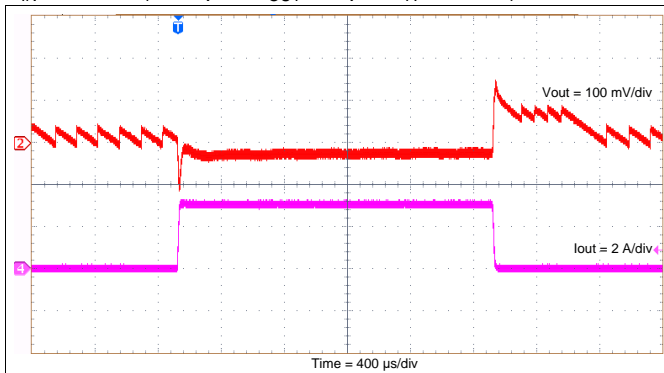

Figure 26. Transient Response 0 to 3 A

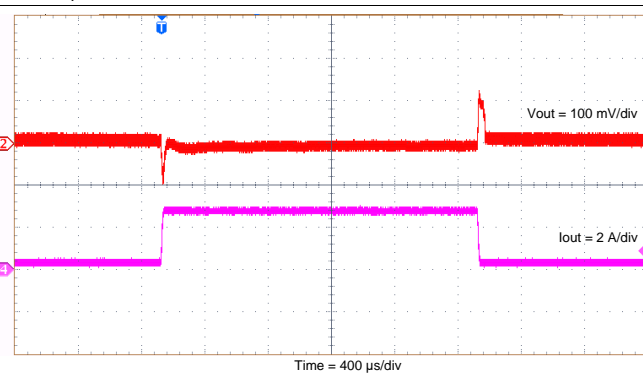

Figure 27. Transient Response 0.3 to 2.7 A

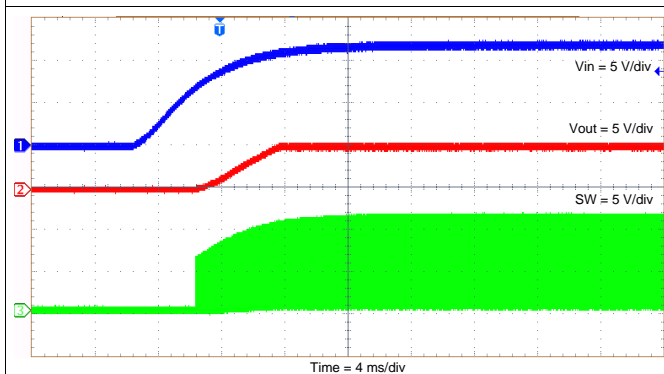

Figure 28. Startup Relative to  $V_{IN}$

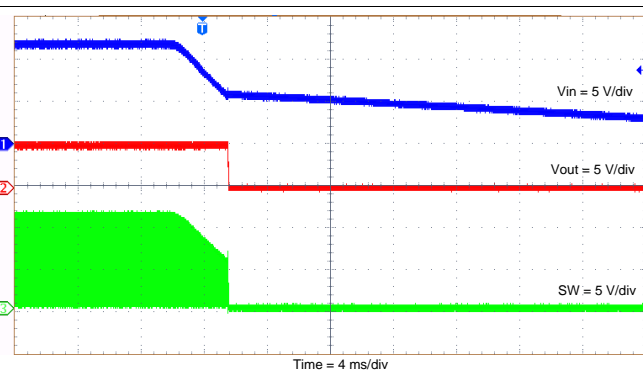

Figure 29. Shutdown Relative to  $V_{IN}$

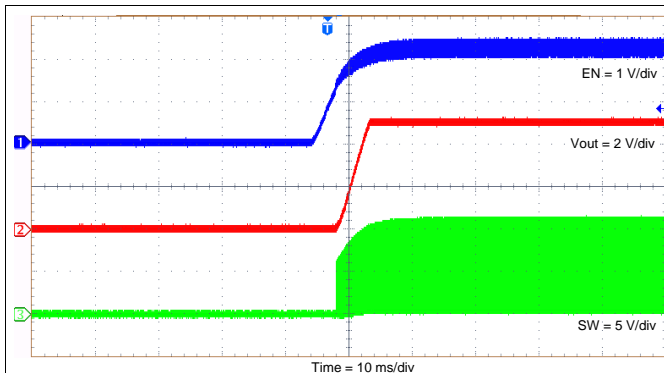

Figure 30. Enable Relative to EN

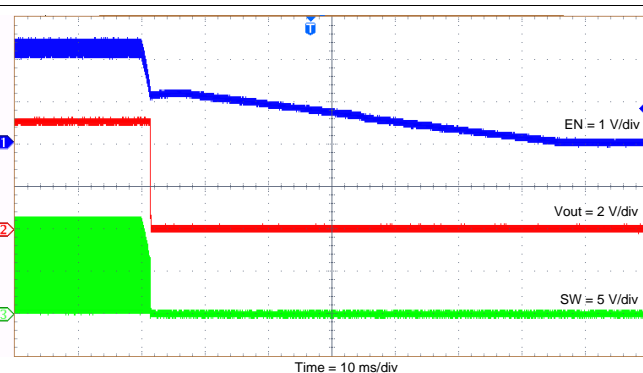
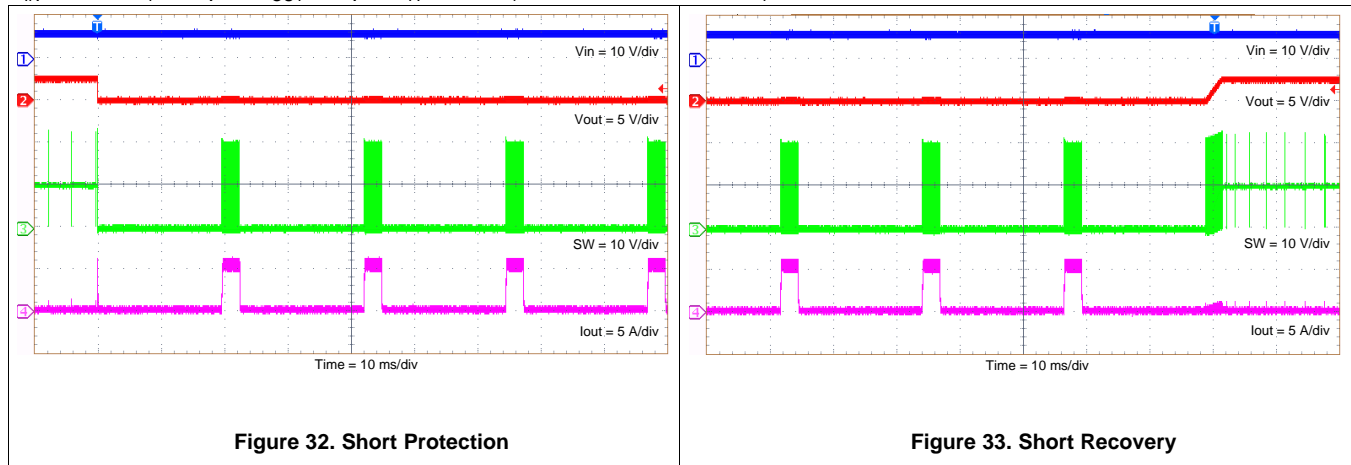

Figure 31. Disable Relative to EN

ADVANCE INFORMATION

$V_{IN} = 12\text{ V}$ ,  $L_1 = 5.6\ \mu\text{H}$ ,  $C_{OUT} = 44\ \mu\text{F}$ ,  $T_A = 25\ ^\circ\text{C}$ . (unless otherwise noted)



**Figure 32. Short Protection**

**Figure 33. Short Recovery**

## 9 Power Supply Recommendations

The devices are designed to operate from an input voltage supply range between 4.5 V and 24 V. This input supply must be well regulated. If the input supply is located more than a few inches from the device or converter, additional bulk capacitance may be required in addition to the ceramic bypass capacitors. An electrolytic capacitor with a value of 47  $\mu\text{F}$  is a typical choice.

## 10 Layout

### 10.1 Layout Guidelines

1. VIN and GND traces should be as wide as possible to reduce trace impedance. The wide areas are also of advantage from the view point of heat dissipation.
2. The input capacitor and output capacitor should be placed as close to the device as possible to minimize trace impedance.
3. Provide sufficient vias for the input capacitor and output capacitor.
4. Keep the SW trace as physically short and wide as practical to minimize radiated emissions.
5. Do not allow switching current to flow under the device.
6. A separate VOUT path should be connected to the upper feedback resistor.
7. Make a Kelvin connection to the GND pin for the feedback path.
8. Voltage feedback loop should be placed away from the high-voltage switching trace, and preferably has ground shield.
9. The trace of the VFB node should be as small as possible to avoid noise coupling.
10. The GND trace between the output capacitor and the GND pin should be as wide as possible to minimize its trace impedance.

### 10.2 Layout Example

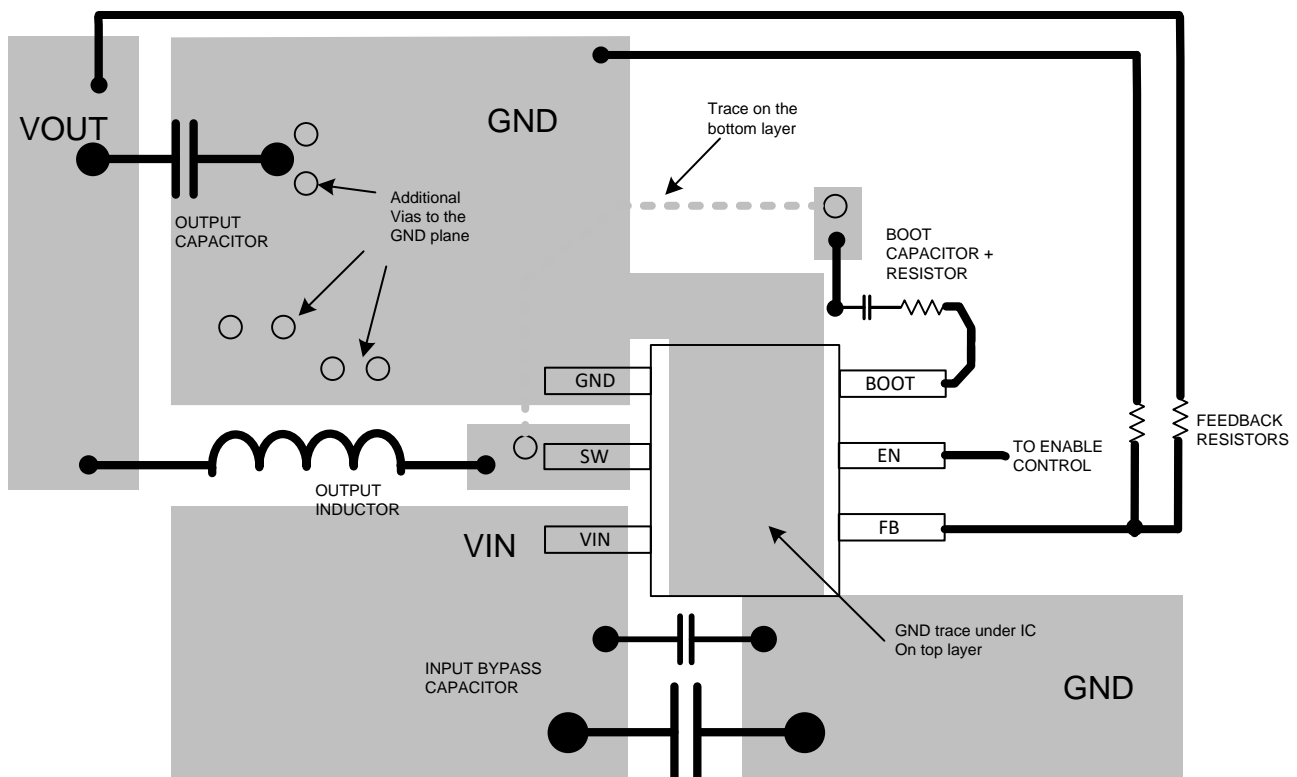

Figure 34. TPS56339 Layout Example

## 11 Device and Documentation Support

### 11.1 Receiving Notification of Documentation Updates

To receive notification of documentation updates, navigate to the device product folder on ti.com. In the upper right corner, click on *Alert me* to register and receive a weekly digest of any product information that has changed. For change details, review the revision history included in any revised document.

### 11.2 Community Resources

The following links connect to TI community resources. Linked contents are provided "AS IS" by the respective contributors. They do not constitute TI specifications and do not necessarily reflect TI's views; see TI's [Terms of Use](#).

**TI E2E™ Online Community** *TI's Engineer-to-Engineer (E2E) Community*. Created to foster collaboration among engineers. At e2e.ti.com, you can ask questions, share knowledge, explore ideas and help solve problems with fellow engineers.

**Design Support** *TI's Design Support* Quickly find helpful E2E forums along with design support tools and contact information for technical support.

### 11.3 Trademarks

E2E is a trademark of Texas Instruments.

### 11.4 Electrostatic Discharge Caution



These devices have limited built-in ESD protection. The leads should be shorted together or the device placed in conductive foam during storage or handling to prevent electrostatic damage to the MOS gates.

### 11.5 Glossary

[SLYZ022](#) — *TI Glossary*.

This glossary lists and explains terms, acronyms, and definitions.

## 12 Mechanical, Packaging, and Orderable Information

The following pages include mechanical, packaging, and orderable information. This information is the most current data available for the designated devices. This data is subject to change without notice and revision of this document. For browser-based versions of this data sheet, refer to the left-hand navigation.

**PACKAGING INFORMATION**

Orderable Device	Status (1)	Package Type	Package Drawing	Pins	Package Qty	Eco Plan (2)	Lead/Ball Finish (6)	MSL Peak Temp (3)	Op Temp (°C)	Device Marking (4/5)	Samples
XTPS56339DDCR	ACTIVE	SOT-23-THIN	DDC	6	3000	TBD	Call TI	Call TI	-40 to 125		Samples

(1) The marketing status values are defined as follows:

**ACTIVE:** Product device recommended for new designs.

**LIFEBUY:** TI has announced that the device will be discontinued, and a lifetime-buy period is in effect.

**NRND:** Not recommended for new designs. Device is in production to support existing customers, but TI does not recommend using this part in a new design.

**PREVIEW:** Device has been announced but is not in production. Samples may or may not be available.

**OBSELETE:** TI has discontinued the production of the device.

(2) **RoHS:** TI defines "RoHS" to mean semiconductor products that are compliant with the current EU RoHS requirements for all 10 RoHS substances, including the requirement that RoHS substance do not exceed 0.1% by weight in homogeneous materials. Where designed to be soldered at high temperatures, "RoHS" products are suitable for use in specified lead-free processes. TI may reference these types of products as "Pb-Free".

**RoHS Exempt:** TI defines "RoHS Exempt" to mean products that contain lead but are compliant with EU RoHS pursuant to a specific EU RoHS exemption.

**Green:** TI defines "Green" to mean the content of Chlorine (Cl) and Bromine (Br) based flame retardants meet JS709B low halogen requirements of <=1000ppm threshold. Antimony trioxide based flame retardants must also meet the <=1000ppm threshold requirement.

(3) MSL, Peak Temp. - The Moisture Sensitivity Level rating according to the JEDEC industry standard classifications, and peak solder temperature.

(4) There may be additional marking, which relates to the logo, the lot trace code information, or the environmental category on the device.

(5) Multiple Device Markings will be inside parentheses. Only one Device Marking contained in parentheses and separated by a "~" will appear on a device. If a line is indented then it is a continuation of the previous line and the two combined represent the entire Device Marking for that device.

(6) Lead/Ball Finish - Orderable Devices may have multiple material finish options. Finish options are separated by a vertical ruled line. Lead/Ball Finish values may wrap to two lines if the finish value exceeds the maximum column width.

**Important Information and Disclaimer:**The information provided on this page represents TI's knowledge and belief as of the date that it is provided. TI bases its knowledge and belief on information provided by third parties, and makes no representation or warranty as to the accuracy of such information. Efforts are underway to better integrate information from third parties. TI has taken and continues to take reasonable steps to provide representative and accurate information but may not have conducted destructive testing or chemical analysis on incoming materials and chemicals. TI and TI suppliers consider certain information to be proprietary, and thus CAS numbers and other limited information may not be available for release.

In no event shall TI's liability arising out of such information exceed the total purchase price of the TI part(s) at issue in this document sold by TI to Customer on an annual basis.

DDC (R-PDSO-G6)

PLASTIC SMALL-OUTLINE

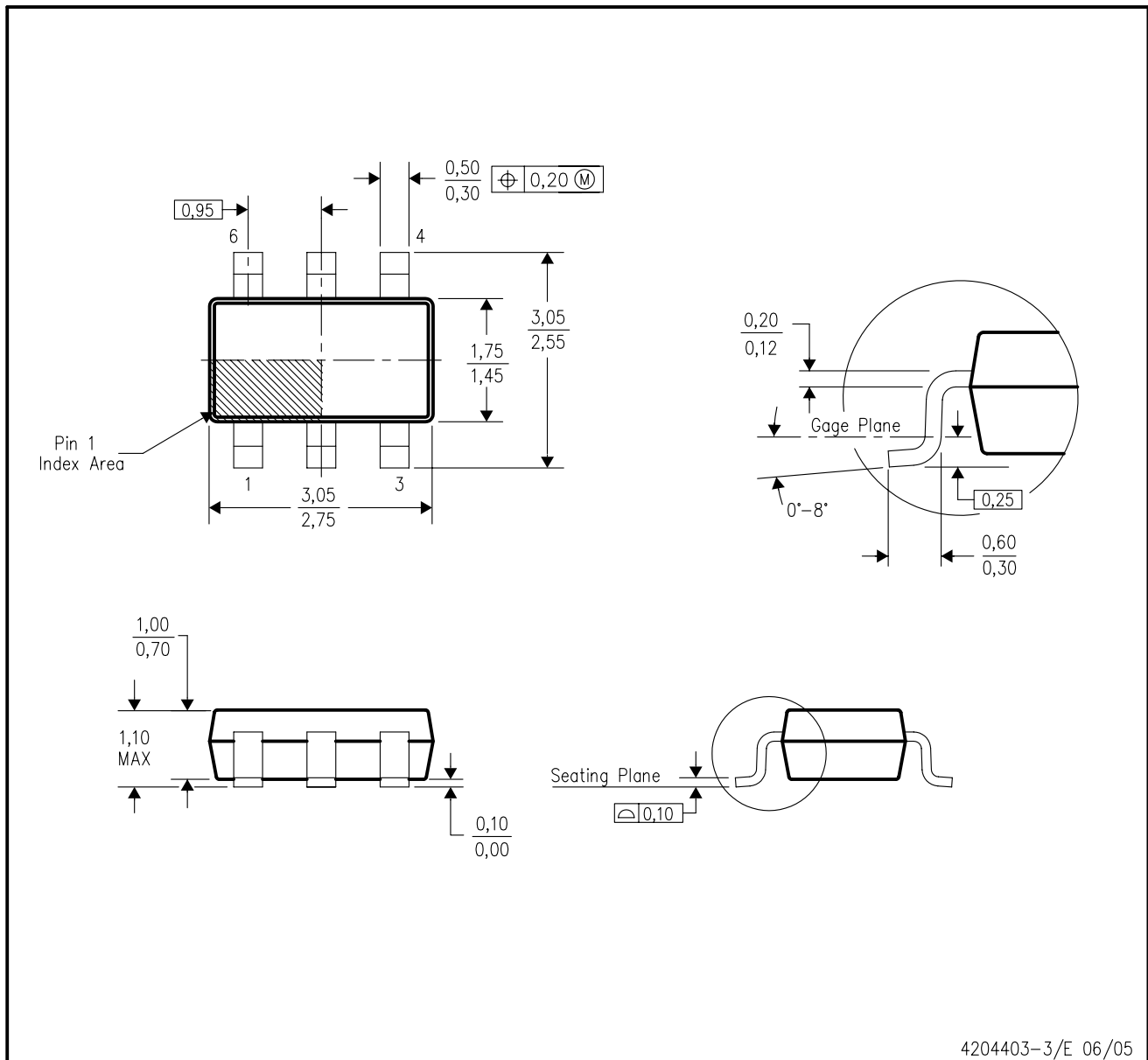

- NOTES:
- All linear dimensions are in millimeters.
  - This drawing is subject to change without notice.
  - Body dimensions do not include mold flash or protrusion.
  - Falls within JEDEC MO-193 variation AA (6 pin).



## IMPORTANT NOTICE AND DISCLAIMER

TI PROVIDES TECHNICAL AND RELIABILITY DATA (INCLUDING DATASHEETS), DESIGN RESOURCES (INCLUDING REFERENCE DESIGNS), APPLICATION OR OTHER DESIGN ADVICE, WEB TOOLS, SAFETY INFORMATION, AND OTHER RESOURCES "AS IS" AND WITH ALL FAULTS, AND DISCLAIMS ALL WARRANTIES, EXPRESS AND IMPLIED, INCLUDING WITHOUT LIMITATION ANY IMPLIED WARRANTIES OF MERCHANTABILITY, FITNESS FOR A PARTICULAR PURPOSE OR NON-INFRINGEMENT OF THIRD PARTY INTELLECTUAL PROPERTY RIGHTS.

These resources are intended for skilled developers designing with TI products. You are solely responsible for (1) selecting the appropriate TI products for your application, (2) designing, validating and testing your application, and (3) ensuring your application meets applicable standards, and any other safety, security, or other requirements. These resources are subject to change without notice. TI grants you permission to use these resources only for development of an application that uses the TI products described in the resource. Other reproduction and display of these resources is prohibited. No license is granted to any other TI intellectual property right or to any third party intellectual property right. TI disclaims responsibility for, and you will fully indemnify TI and its representatives against, any claims, damages, costs, losses, and liabilities arising out of your use of these resources.

TI's products are provided subject to TI's Terms of Sale ([www.ti.com/legal/termsofsale.html](http://www.ti.com/legal/termsofsale.html)) or other applicable terms available either on [ti.com](http://ti.com) or provided in conjunction with such TI products. TI's provision of these resources does not expand or otherwise alter TI's applicable warranties or warranty disclaimers for TI products.

Mailing Address: Texas Instruments, Post Office Box 655303, Dallas, Texas 75265  
Copyright © 2018, Texas Instruments Incorporated