

## FEATURES

- Parameters Specified at 2.7-V, 5-V, and 15-V Supplies
- Supply Current 7  $\mu$ A (Typ) at 5 V
- Response Time 4  $\mu$ s (Typ) at 5 V
- Push-Pull Output
- Input Common-Mode Range Beyond  $V_{CC-}$  and  $V_{CC+}$
- Low Input Current

## APPLICATIONS

- Battery-Powered Products
- Notebooks and PDAs
- Mobile Communications
- Alarm and Security Circuits
- Direct Sensor Interface
- Replaces Amplifiers Used as Comparators With Better Performance and Lower Current

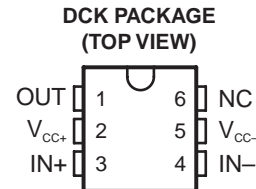
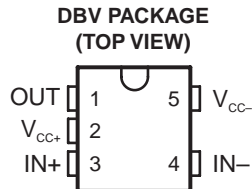
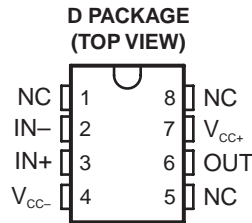

NC – No internal connection

## DESCRIPTION/ORDERING INFORMATION

The TLV7211 and TLV7211A are micropower CMOS comparators available in the space-saving SOT-23-5 package. This makes the comparators ideal for space- and weight-critical designs. The TLV7211A features an input offset voltage of 5 mV, and the TLV7211 features an input offset voltage of 15 mV.

The main benefits of the SOT-23-5 package are most apparent in small portable electronic devices, such as mobile phones, pagers, notebook computers, personal digital assistants, and PCMCIA cards. The rail-to-rail input voltage makes the TLV7211 or TLV7211A a good choice for sensor interfacing, such as light detector circuits, optical and magnetic sensors, and alarm and status circuits.

The SOT-23-5 package's small size allows it to fit into tight spaces on PC boards.

## ORDERING INFORMATION

$T_A$	$V_{OS}$ (MAX)	PACKAGE <sup>(1)</sup>		ORDERABLE PART NUMBER	TOP-SIDE MARKING <sup>(2)</sup>
–40°C to 85°C	5 mV	SOIC – D	Reel of 2500	TLV7211AIDR	7211AI
			Tube of 75	TLV7211AID	
		SOT-23-5 – DBV	Reel of 3000	TLV7211AIDBVR	YBN_
	SOT (SC-70) – DCK	Reel of 3000	TLV7211AIDCKR	Y8_	
		Reel of 250	TLV7211AIDCKT		
	–40°C to 85°C	15 mV	SOIC – D	Reel of 2500	TLV7211IDR
Tube of 75				TLV7211ID	
SOT-23-5 – DBV			Reel of 3000	TLV7211IDBVR	YBK_
SOT (SC-70) – DCK		Reel of 3000	TLV7211IDCKR	Y7_	
		Reel of 250	TLV7211IDCKT		

(1) Package drawings, standard packing quantities, thermal data, symbolization, and PCB design guidelines are available at [www.ti.com/sc/package](http://www.ti.com/sc/package).

(2) DBV/DCK: The actual top-side marking has one additional character that designates the assembly/test site.



Please be aware that an important notice concerning availability, standard warranty, and use in critical applications of Texas Instruments semiconductor products and disclaimers thereto appears at the end of this data sheet.

# TLV7211, TLV7211A CMOS COMPARATORS WITH RAIL-TO-RAIL INPUT AND PUSH-PULL OUTPUT

SLCS149B – AUGUST 2006 – REVISED JANUARY 2007

## FUNCTIONAL BLOCK DIAGRAM

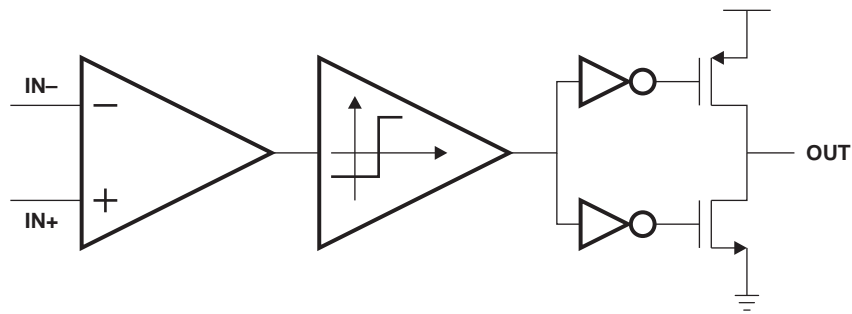

### Absolute Maximum Ratings<sup>(1)</sup>

over operating free-air temperature range (unless otherwise noted)

		MIN	MAX	UNIT
$V_{CC+} - V_{CC-}$	Supply voltage <sup>(2)</sup>		16	V
$V_{ID}$	Differential input voltage <sup>(3)</sup>		±Supply voltage	V
$V_I$	Input voltage range (any input)	$V_{CC-} - 0.3$	$V_{CC+} + 0.3$	V
$V_O$	Output voltage range	$V_{CC-} - 0.3$	$V_{CC+} + 0.3$	V
$I_{CC}$	Supply current		40	mA
$I_I$	Input current		±5	mA
$I_O$	Output current		±30	mA
$\theta_{JA}$	Package thermal impedance <sup>(4)(5)</sup>	D package	97	°C/W
		DBV package	206	
		DCK package	259	
$T_J$	Operating virtual junction temperature		150	°C
$T_{stg}$	Storage temperature range	-65	150	°C

- (1) Stresses beyond those listed under "absolute maximum ratings" may cause permanent damage to the device. These are stress ratings only, and functional operation of the device at these or any other conditions beyond those indicated under "recommended operating conditions" is not implied. Exposure to absolute-maximum-rated conditions for extended periods may affect device reliability.
- (2) All voltage values (except differential voltages and  $V_{CC}$  specified for the measurement of  $I_{OS}$ ) are with respect to the network GND.
- (3) Differential voltages are at IN+ with respect to IN-.
- (4) Maximum power dissipation is a function of  $T_J(\text{max})$ ,  $\theta_{JA}$ , and  $T_A$ . The maximum allowable power dissipation at any allowable ambient temperature is  $P_D = (T_J(\text{max}) - T_A)/\theta_{JA}$ . Operating at the absolute maximum  $T_J$  of 150°C can affect reliability.
- (5) The package thermal impedance is calculated in accordance with JESD 51-7.

### ESD Protection

	TYP	UNIT
Human-Body Model	2000	V

### Recommended Operating Conditions

	MIN	MAX	UNIT
$V_{CC+} - V_{CC-}$	2.7	15	V
$T_J$	-40	85	°C

**2.7-V Electrical Characteristics**
 $V_{CC+} = 2.7\text{ V}$ ,  $V_{CC-} = \text{GND}$ ,  $V_{CM} = V_O = V_{CC+}/2$ , and  $R_L > 1\text{ M}\Omega$  (unless otherwise noted)

PARAMETER	TEST CONDITIONS	T <sub>J</sub>	TLV7211A			TLV7211			UNIT	
			MIN	TYP	MAX	MIN	TYP	MAX		
V <sub>OS</sub>	Input offset voltage	25°C		3	5		3	15	mV	
		–40°C to 85°C			8			18		
TCV <sub>OS</sub>	Input offset voltage temperature drift	25°C		1			1		μV/°C	
	Input offset voltage average drift <sup>(1)</sup>	25°C		3.3			3.3		μV/month	
I <sub>B</sub>	Input current	25°C		0.04			0.04		pA	
I <sub>OS</sub>	Input offset current	25°C		0.02			0.02		pA	
CMRR	Common-mode rejection ratio	0 ≤ V <sub>CM</sub> ≤ 2.7 V		75			75		dB	
PSRR	Power-supply rejection ratio	2.7 V ≤ V <sub>CC+</sub> ≤ 15 V		80			80		dB	
A <sub>V</sub>	Voltage gain	25°C		100			100		dB	
CMVR	Input common-mode voltage range	CMRR > 55 dB	25°C	2.9	3		2.9	3	V	
			–40°C to 85°C	2.7			2.7			
		CMRR > 55 dB	25°C		–0.3	–0.2		–0.3		–0.2
			–40°C to 85°C			0				0
V <sub>OH</sub>	High-level output voltage	I <sub>load</sub> = 2.5 mA	25°C	2.4	2.5		2.4	2.5	V	
			–40°C to 85°C	2.3			2.3			
V <sub>OL</sub>	Low-level output voltage	I <sub>load</sub> = 2.5 mA	25°C		0.2	0.3		0.2	0.3	V
			–40°C to 85°C			0.4			0.4	
I <sub>CC</sub>	Supply current	V <sub>OUT</sub> = Low	25°C		7	12		7	12	μA
			–40°C to 85°C			14			14	
		V <sub>OUT</sub> = High-Idle	25°C		5	10		5	10	
			–40°C to 85°C			12			12	

(1) Input offset voltage average drift is calculated by dividing the accelerated operating life V<sub>OS</sub> drift by the equivalent operational time. This represents worst-case input conditions and includes the first 30 days of drift.

# TLV7211, TLV7211A CMOS COMPARATORS WITH RAIL-TO-RAIL INPUT AND PUSH-PULL OUTPUT

SLCS149B – AUGUST 2006 – REVISED JANUARY 2007

## 5-V Electrical Characteristics

$V_{CC+} = 5\text{ V}$ ,  $V_{CC-} = \text{GND}$ ,  $V_{CM} = V_O = V_{CC+}/2$ , and  $R_L > 1\text{ M}\Omega$  (unless otherwise noted)

PARAMETER	TEST CONDITIONS	T <sub>J</sub>	TLV7211A			TLV7211			UNIT	
			MIN	TYP	MAX	MIN	TYP	MAX		
V <sub>OS</sub>	Input offset voltage	25°C		3	5		3	15	mV	
		-40°C to 85°C			8			18		
TCV <sub>OS</sub>	Input offset voltage temperature drift	25°C		1			1		μV/°C	
	Input offset voltage average drift <sup>(1)</sup>	25°C		3.3			3.3		μV/month	
I <sub>B</sub>	Input current	25°C		0.04			0.04		pA	
I <sub>OS</sub>	Input offset current	25°C		0.02			0.02		pA	
CMRR	Common-mode rejection ratio	25°C		75			75		dB	
PSRR	Power-supply rejection ratio	5 V ≤ V <sub>CC+</sub> ≤ 10 V	25°C		80		80		dB	
A <sub>V</sub>	Voltage gain	25°C		100			100		dB	
CMVR	Input common-mode voltage range	CMRR > 55 dB	25°C	5.2	5.3		5.2	5.3	V	
			-40°C to 85°C	5			5			
		CMRR > 55 dB	25°C		-0.3	-0.2		-0.3		-0.2
			-40°C to 85°C			0				0
V <sub>OH</sub>	High-level output voltage	I <sub>load</sub> = 5 mA	25°C	4.6	4.8		4.6	4.8	V	
			-40°C to 85°C	4.45			4.45			
V <sub>OL</sub>	Low-level output voltage	I <sub>load</sub> = 5 mA	25°C		0.2	0.4		0.2	0.4	V
			-40°C to 85°C			0.55			0.55	
I <sub>CC</sub>	Supply current	V <sub>OUT</sub> = Low	25°C		7	14		7	14	μA
			-40°C to 85°C			18			18	
		V <sub>OUT</sub> = High-Idle	25°C		5	10		5	10	
			-40°C to 85°C			13			13	
I <sub>OH</sub>	Short-circuit output current	I <sub>source</sub>	25°C		30		30		mA	
I <sub>OL</sub>	Short-circuit output current	I <sub>sink</sub> , V <sub>O</sub> < 12 V <sup>(2)</sup>	25°C		45		45		mA	

(1) Input offset voltage average drift is calculated by dividing the accelerated operating life V<sub>OS</sub> drift by the equivalent operational time. This represents worst-case input conditions and includes the first 30 days of drift.

(2) Do not short circuit the output to V+ if V+ is >12 V.

### 15-V Electrical Characteristics

$V_{CC+} = 15\text{ V}$ ,  $V_{CC-} = \text{GND}$ ,  $V_{CM} = V_O = V_{CC+}/2$ , and  $R_L > 1\text{ M}\Omega$  (unless otherwise noted)

PARAMETER	TEST CONDITIONS	$T_J$	TLV7211A			TLV7211			UNIT
			MIN	TYP	MAX	MIN	TYP	MAX	
$V_{OS}$ Input offset voltage		25°C		3	5		3	15	mV
		-40°C to 85°C			8			18	
$TCV_{OS}$ Input offset voltage temperature drift		25°C		4			4		$\mu\text{V}/^\circ\text{C}$
Input offset voltage average drift <sup>(1)</sup>		25°C		4			4		$\mu\text{V}/\text{month}$
$I_B$ Input current		25°C		0.04			0.04		pA
$I_{OS}$ Input offset current		25°C		0.02			0.02		pA
CMRR Common-mode rejection ratio		25°C		82			82		dB
PSRR Power-supply rejection ratio	$5\text{ V} \leq V_{CC+} \leq 10\text{ V}$	25°C		80			80		dB
$A_V$ Voltage gain		25°C		100			100		dB
$CMVR$ Input common-mode voltage range	CMRR > 55 dB	25°C	15.2	15.3		15.2	15.3		V
		-40°C to 85°C	15			15			
	CMRR > 55 dB	25°C		-0.3	-0.2		-0.3	-0.2	
		-40°C to 85°C			0			0	
$V_{OH}$ High-level output voltage	$I_{load} = 5\text{ mA}$	25°C	14.6	14.8		14.6	14.8		V
		-40°C to 85°C	14.45			14.45			
$V_{OL}$ Low-level output voltage	$I_{load} = 5\text{ mA}$	25°C		0.2	0.4		0.2	0.4	V
		-40°C to 85°C			0.55			0.55	
$I_{CC}$ Supply current	$V_{OUT} = \text{Low}$	25°C		7	14		7	14	$\mu\text{A}$
		-40°C to 85°C			18			18	
	$V_{OUT} = \text{High-Idle}$	25°C		5	12		5	12	
		-40°C to 85°C			14			14	
$I_{OH}$ Short-circuit output current	$I_{source}$	25°C		30			30		mA
$I_{OL}$ Short-circuit output current	$I_{sink}$ , $V_O < 12\text{ V}^{(2)}$	25°C		45			45		mA

- (1) Input offset voltage average drift is calculated by dividing the accelerated operating life  $V_{OS}$  drift by the equivalent operational time. This represents worst-case input conditions and includes the first 30 days of drift.  
(2) Do not short circuit the output to  $V+$  if  $V+$  is >12 V.

# TLV7211, TLV7211A CMOS COMPARATORS WITH RAIL-TO-RAIL INPUT AND PUSH-PULL OUTPUT

SLCS149B – AUGUST 2006 – REVISED JANUARY 2007

## Switching Characteristics

$T_J = 25^\circ\text{C}$ ,  $V_{CC+} = 5\text{ V}$ ,  $V_{CC-} = \text{GND}$ ,  $V_{CM} = V_O = V_{CC+}/2$ , and  $R_L > 1\text{ M}\Omega$  (unless otherwise noted)

PARAMETER		TEST CONDITIONS		TYP	UNIT
$t_{rise}$	Rise time	$f = 10\text{ kHz}$ , $C_L = 50\text{ pF}^{(1)}$ , Overdrive = 10 mV		0.3	$\mu\text{s}$
$t_{fall}$	Fall time	$f = 10\text{ kHz}$ , $C_L = 50\text{ pF}^{(1)}$ , Overdrive = 10 mV		0.3	$\mu\text{s}$
$t_{PHL}$	Propagation delay time, high to low <sup>(2)</sup>	$f = 10\text{ kHz}$ , $C_L = 50\text{ pF}^{(1)}$	10 mV	10	$\mu\text{s}$
			100 mV	4	
		$V_{CC+} = 2.7\text{ V}$ , $f = 10\text{ kHz}$ , $C_L = 50\text{ pF}^{(1)}$	10 mV	10	
			100 mV	4	
$t_{PLH}$	Propagation delay time, low to high <sup>(2)</sup>	$f = 10\text{ kHz}$ , $C_L = 50\text{ pF}^{(1)}$	10 mV	6	$\mu\text{s}$
			100 mV	4	
		$V_{CC+} = 2.7\text{ V}$ , $f = 10\text{ kHz}$ , $C_L = 50\text{ pF}^{(1)}$	10 mV	7	
			100 mV	4	

(1)  $C_L$  includes probe and jig capacitance.

(2) Input step voltage for propagation delay measurement is 2 V.

**TYPICAL CHARACTERISTICS**

**SUPPLY CURRENT**  
**vs**  
**SUPPLY VOLTAGE**  
**(SOURCING)**

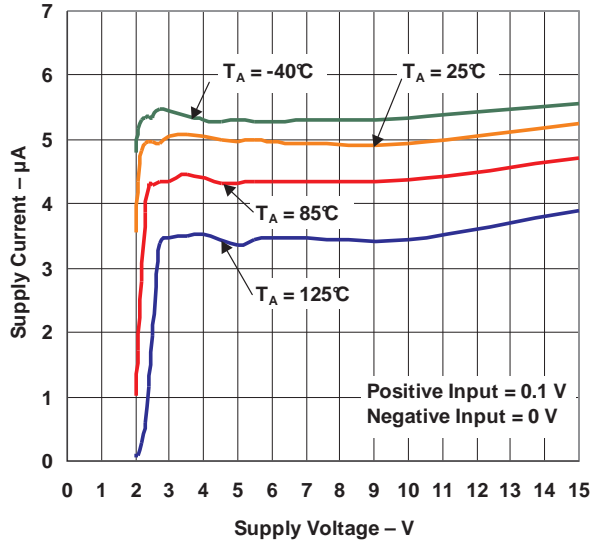

**SUPPLY CURRENT**  
**vs**  
**SUPPLY VOLTAGE**  
**(SINKING)**

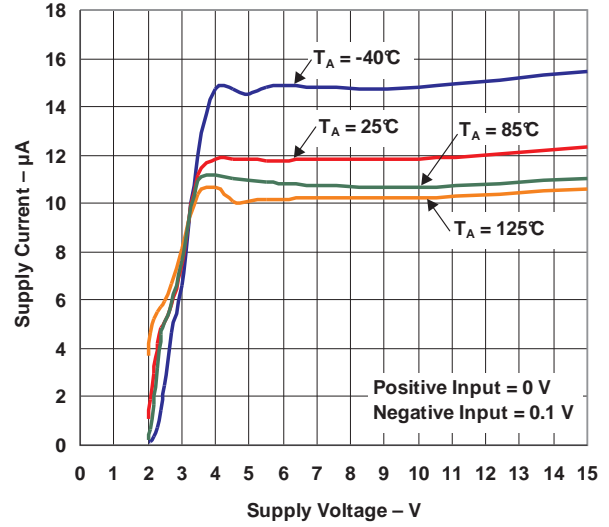

**SUPPLY CURRENT**  
**vs**  
**TEMPERATURE**  
**(SOURCING)**

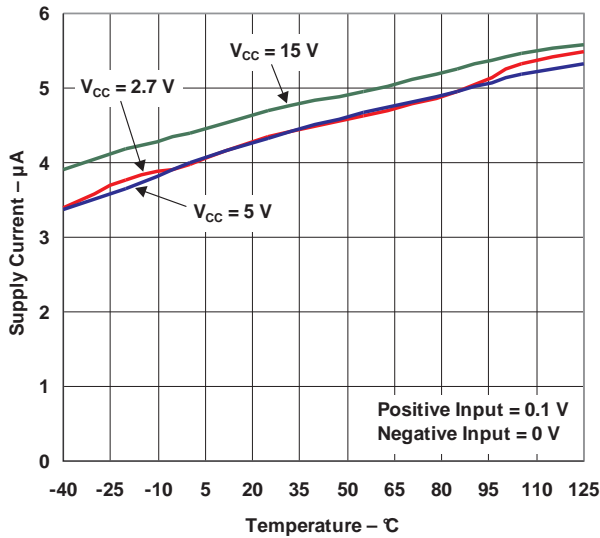

**SUPPLY CURRENT**  
**vs**  
**TEMPERATURE**  
**(SINKING)**

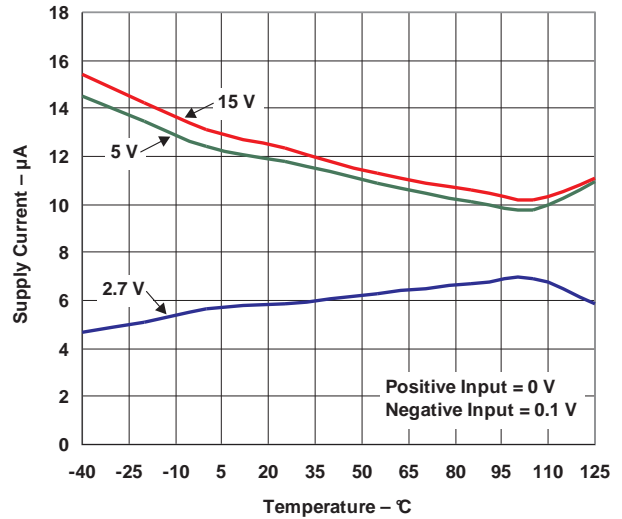

TYPICAL CHARACTERISTICS (continued)

OUTPUT SOURCING CURRENT  
 VS  
 SUPPLY VOLTAGE

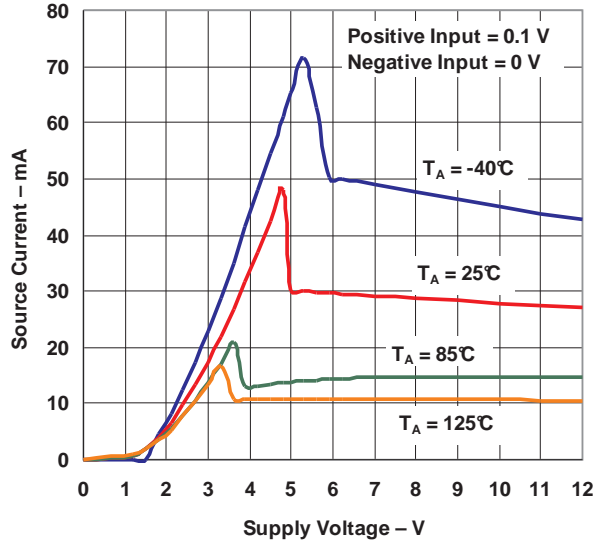

OUTPUT SINKING CURRENT  
 VS  
 SUPPLY VOLTAGE

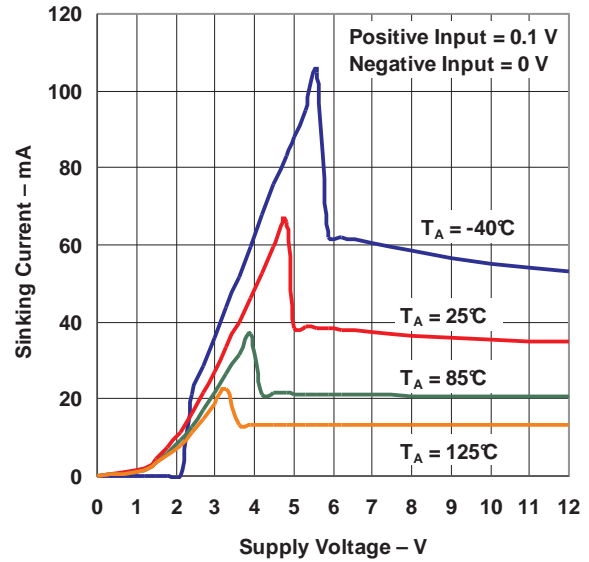

OUTPUT VOLTAGE  
 VS  
 OUTPUT SOURCING CURRENT

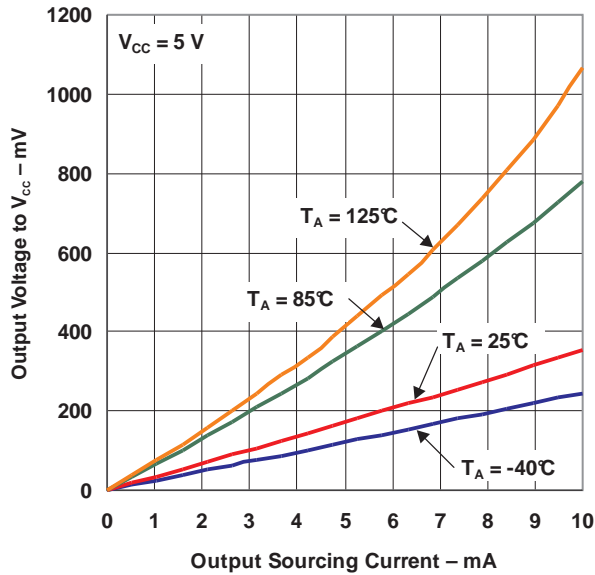

OUTPUT VOLTAGE  
 VS  
 OUTPUT SINKING CURRENT

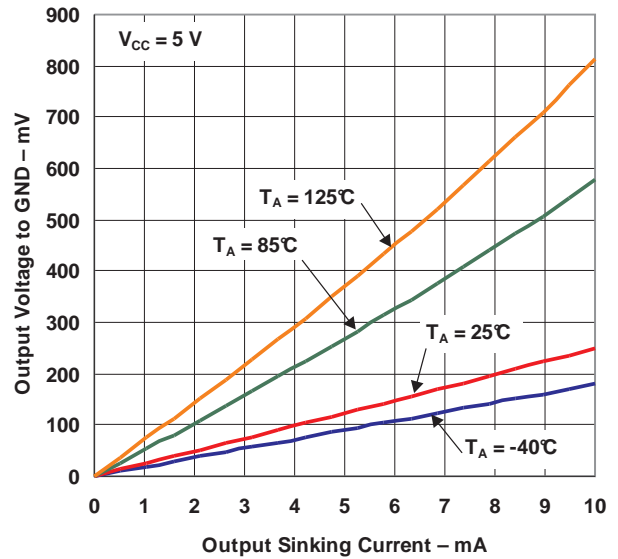



TYPICAL CHARACTERISTICS (continued)

OUTPUT VOLTAGE  
VS  
OUTPUT SOURCING CURRENT

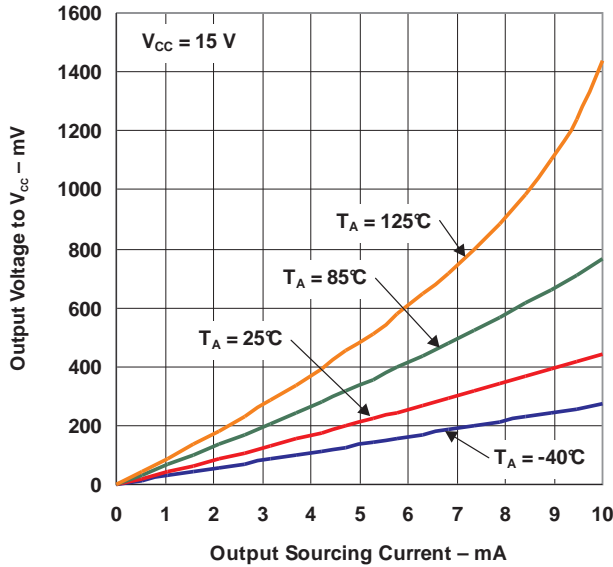

OUTPUT VOLTAGE  
VS  
OUTPUT SINKING CURRENT

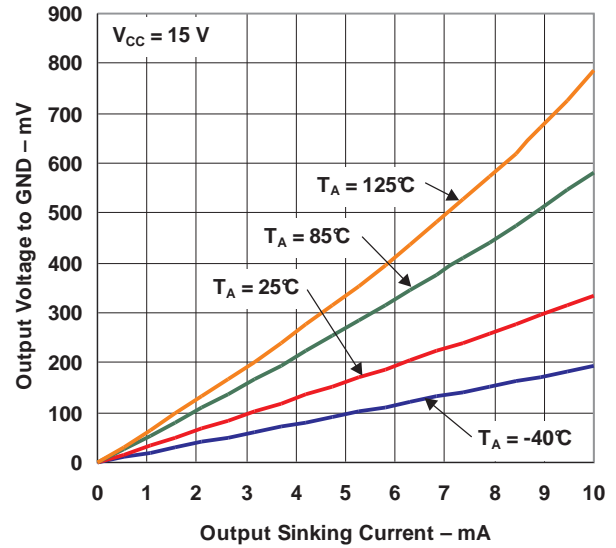

Response Time ( $t_{PLH}$ ) for Various Input Overdrives  
( $V_{CC} = 2.7\text{ V}$ )

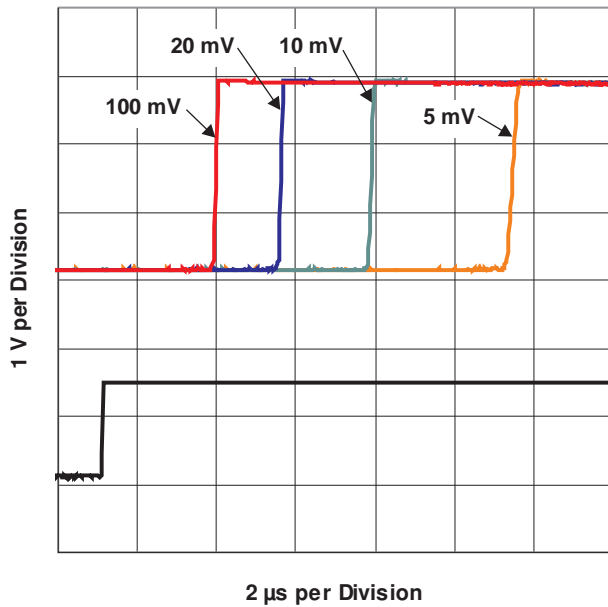

Response Time ( $t_{PHL}$ ) for Various Input Overdrives  
( $V_{CC} = 2.7\text{ V}$ )

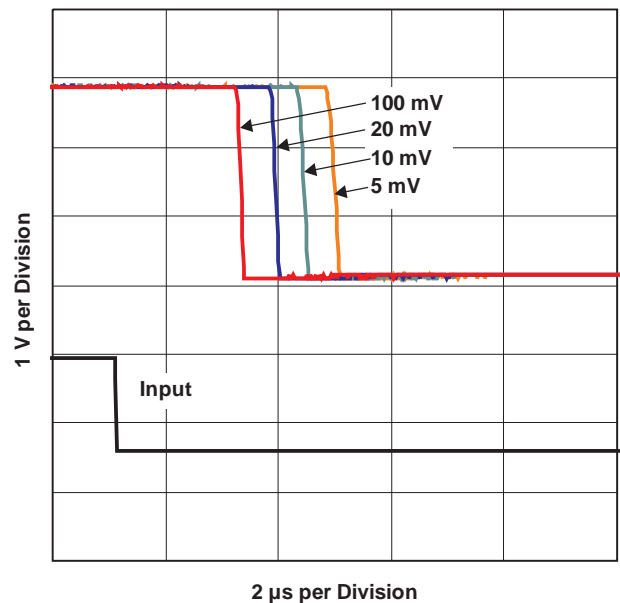

TYPICAL CHARACTERISTICS (continued)

Response Time ( $t_{PLH}$ ) for Various Input Overdrives  
 ( $V_{CC} = 5\text{ V}$ )

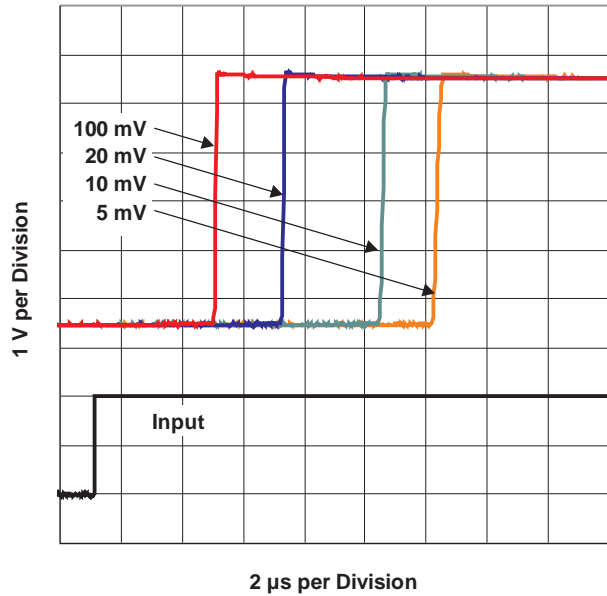

Response Time ( $t_{PHL}$ ) for Various Input Overdrives  
 ( $V_{CC} = 5\text{ V}$ )

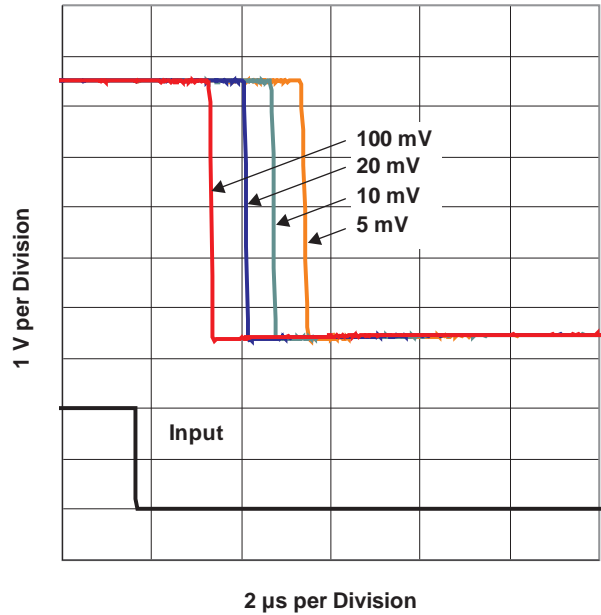

Response Time ( $t_{PLH}$ ) for Various Input Overdrives  
 ( $V_{CC} = 15\text{ V}$ )

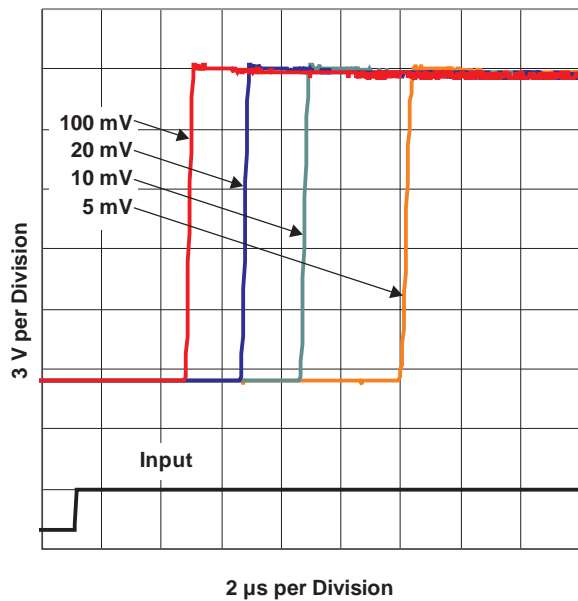

Response Time ( $t_{PHL}$ ) for Various Input Overdrives  
 ( $V_{CC} = 15\text{ V}$ )

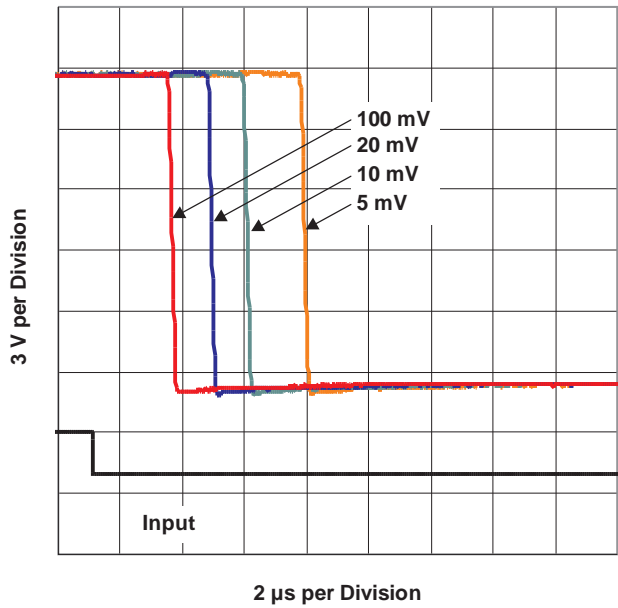

**PACKAGING INFORMATION**

Orderable Device	Status (1)	Package Type	Package Drawing	Pins	Package Qty	Eco Plan (2)	Lead finish/ Ball material (6)	MSL Peak Temp (3)	Op Temp (°C)	Device Marking (4/5)	Samples
TLV7211AID	ACTIVE	SOIC	D	8	75	RoHS & Green	NIPDAU	Level-1-260C-UNLIM	-40 to 85	7211AI	<a href="#">Samples</a>
TLV7211AIDBVR	ACTIVE	SOT-23	DBV	5	3000	RoHS & Green	NIPDAU	Level-1-260C-UNLIM	-40 to 85	YBNM	<a href="#">Samples</a>
TLV7211AIDCKR	ACTIVE	SC70	DCK	6	3000	RoHS & Green	NIPDAU   SN	Level-1-260C-UNLIM	-40 to 85	Y8A	<a href="#">Samples</a>
TLV7211AIDCKT	LIFEBUY	SC70	DCK	6	250	RoHS & Green	NIPDAU	Level-1-260C-UNLIM	-40 to 85	Y8A	
TLV7211AIDR	ACTIVE	SOIC	D	8	2500	RoHS & Green	NIPDAU	Level-1-260C-UNLIM	-40 to 85	7211AI	<a href="#">Samples</a>
TLV7211ID	ACTIVE	SOIC	D	8	75	RoHS & Green	NIPDAU	Level-1-260C-UNLIM	-40 to 85	TY7211	<a href="#">Samples</a>
TLV7211IDBVR	ACTIVE	SOT-23	DBV	5	3000	RoHS & Green	NIPDAU	Level-1-260C-UNLIM	-40 to 85	YBKM	<a href="#">Samples</a>
TLV7211IDCKR	ACTIVE	SC70	DCK	6	3000	RoHS & Green	NIPDAU   SN	Level-1-260C-UNLIM	-40 to 85	Y7A	<a href="#">Samples</a>
TLV7211IDR	ACTIVE	SOIC	D	8	2500	RoHS & Green	NIPDAU	Level-1-260C-UNLIM	-40 to 85	TY7211	<a href="#">Samples</a>

(1) The marketing status values are defined as follows:

**ACTIVE:** Product device recommended for new designs.

**LIFEBUY:** TI has announced that the device will be discontinued, and a lifetime-buy period is in effect.

**NRND:** Not recommended for new designs. Device is in production to support existing customers, but TI does not recommend using this part in a new design.

**PREVIEW:** Device has been announced but is not in production. Samples may or may not be available.

**OBSOLETE:** TI has discontinued the production of the device.

(2) **RoHS:** TI defines "RoHS" to mean semiconductor products that are compliant with the current EU RoHS requirements for all 10 RoHS substances, including the requirement that RoHS substance do not exceed 0.1% by weight in homogeneous materials. Where designed to be soldered at high temperatures, "RoHS" products are suitable for use in specified lead-free processes. TI may reference these types of products as "Pb-Free".

**RoHS Exempt:** TI defines "RoHS Exempt" to mean products that contain lead but are compliant with EU RoHS pursuant to a specific EU RoHS exemption.

**Green:** TI defines "Green" to mean the content of Chlorine (Cl) and Bromine (Br) based flame retardants meet JS709B low halogen requirements of <=1000ppm threshold. Antimony trioxide based flame retardants must also meet the <=1000ppm threshold requirement.

(3) MSL, Peak Temp. - The Moisture Sensitivity Level rating according to the JEDEC industry standard classifications, and peak solder temperature.

(4) There may be additional marking, which relates to the logo, the lot trace code information, or the environmental category on the device.

<sup>(5)</sup> Multiple Device Markings will be inside parentheses. Only one Device Marking contained in parentheses and separated by a "~" will appear on a device. If a line is indented then it is a continuation of the previous line and the two combined represent the entire Device Marking for that device.

<sup>(6)</sup> Lead finish/Ball material - Orderable Devices may have multiple material finish options. Finish options are separated by a vertical ruled line. Lead finish/Ball material values may wrap to two lines if the finish value exceeds the maximum column width.

**Important Information and Disclaimer:**The information provided on this page represents TI's knowledge and belief as of the date that it is provided. TI bases its knowledge and belief on information provided by third parties, and makes no representation or warranty as to the accuracy of such information. Efforts are underway to better integrate information from third parties. TI has taken and continues to take reasonable steps to provide representative and accurate information but may not have conducted destructive testing or chemical analysis on incoming materials and chemicals. TI and TI suppliers consider certain information to be proprietary, and thus CAS numbers and other limited information may not be available for release.

In no event shall TI's liability arising out of such information exceed the total purchase price of the TI part(s) at issue in this document sold by TI to Customer on an annual basis.

**TAPE AND REEL INFORMATION**

**QUADRANT ASSIGNMENTS FOR PIN 1 ORIENTATION IN TAPE**

\*All dimensions are nominal

Device	Package Type	Package Drawing	Pins	SPQ	Reel Diameter (mm)	Reel Width W1 (mm)	A0 (mm)	B0 (mm)	K0 (mm)	P1 (mm)	W (mm)	Pin1 Quadrant
TLV7211AIDBVR	SOT-23	DBV	5	3000	178.0	9.0	3.3	3.2	1.4	4.0	8.0	Q3
TLV7211AIDCKR	SC70	DCK	6	3000	180.0	8.4	2.41	2.41	1.2	4.0	8.0	Q3
TLV7211AIDCKT	SC70	DCK	6	250	180.0	8.4	2.41	2.41	1.2	4.0	8.0	Q3
TLV7211AIDR	SOIC	D	8	2500	330.0	12.4	6.4	5.2	2.1	8.0	12.0	Q1
TLV7211IDBVR	SOT-23	DBV	5	3000	178.0	9.0	3.23	3.17	1.37	4.0	8.0	Q3
TLV7211IDCKR	SC70	DCK	6	3000	180.0	8.4	2.41	2.41	1.2	4.0	8.0	Q3
TLV7211IDR	SOIC	D	8	2500	330.0	12.4	6.4	5.2	2.1	8.0	12.0	Q1

**TAPE AND REEL BOX DIMENSIONS**

\*All dimensions are nominal

Device	Package Type	Package Drawing	Pins	SPQ	Length (mm)	Width (mm)	Height (mm)
TLV7211AIDBVR	SOT-23	DBV	5	3000	180.0	180.0	18.0
TLV7211AIDCKR	SC70	DCK	6	3000	202.0	201.0	28.0
TLV7211AIDCKT	SC70	DCK	6	250	202.0	201.0	28.0
TLV7211AIDR	SOIC	D	8	2500	340.5	338.1	20.6
TLV7211IDBVR	SOT-23	DBV	5	3000	180.0	180.0	18.0
TLV7211IDCKR	SC70	DCK	6	3000	202.0	201.0	28.0
TLV7211IDR	SOIC	D	8	2500	340.5	338.1	20.6

**TUBE**

\*All dimensions are nominal

Device	Package Name	Package Type	Pins	SPQ	L (mm)	W (mm)	T (μm)	B (mm)
TLV7211AID	D	SOIC	8	75	507	8	3940	4.32
TLV7211ID	D	SOIC	8	75	507	8	3940	4.32

DCK (R-PDSO-G6)

PLASTIC SMALL-OUTLINE PACKAGE



- NOTES:
- A. All linear dimensions are in millimeters.
  - B. This drawing is subject to change without notice.
  - C. Body dimensions do not include mold flash or protrusion. Mold flash and protrusion shall not exceed 0.15 per side.
  - D. Falls within JEDEC MO-203 variation AB.



DCK (R-PDSO-G6)

PLASTIC SMALL OUTLINE



- NOTES:
- All linear dimensions are in millimeters.
  - This drawing is subject to change without notice.
  - Customers should place a note on the circuit board fabrication drawing not to alter the center solder mask defined pad.
  - Publication IPC-7351 is recommended for alternate designs.
  - Laser cutting apertures with trapezoidal walls and also rounding corners will offer better paste release. Customers should contact their board assembly site for stencil design recommendations. Example stencil design based on a 50% volumetric metal load solder paste. Refer to IPC-7525 for other stencil recommendations.

# DBV0005A



# PACKAGE OUTLINE

SOT-23 - 1.45 mm max height

SMALL OUTLINE TRANSISTOR



4214839/J 02/2024

NOTES:

- All linear dimensions are in millimeters. Any dimensions in parenthesis are for reference only. Dimensioning and tolerancing per ASME Y14.5M.
- This drawing is subject to change without notice.
- Reference JEDEC MO-178.
- Body dimensions do not include mold flash, protrusions, or gate burrs. Mold flash, protrusions, or gate burrs shall not exceed 0.25 mm per side.
- Support pin may differ or may not be present.

# EXAMPLE BOARD LAYOUT

DBV0005A

SOT-23 - 1.45 mm max height

SMALL OUTLINE TRANSISTOR



LAND PATTERN EXAMPLE  
EXPOSED METAL SHOWN  
SCALE:15X



SOLDER MASK DETAILS

4214839/J 02/2024

NOTES: (continued)

- 6. Publication IPC-7351 may have alternate designs.
- 7. Solder mask tolerances between and around signal pads can vary based on board fabrication site.

# EXAMPLE STENCIL DESIGN

DBV0005A

SOT-23 - 1.45 mm max height

SMALL OUTLINE TRANSISTOR



SOLDER PASTE EXAMPLE  
BASED ON 0.125 mm THICK STENCIL  
SCALE:15X

4214839/J 02/2024

NOTES: (continued)

8. Laser cutting apertures with trapezoidal walls and rounded corners may offer better paste release. IPC-7525 may have alternate design recommendations.
9. Board assembly site may have different recommendations for stencil design.



D0008A

# PACKAGE OUTLINE

SOIC - 1.75 mm max height

SMALL OUTLINE INTEGRATED CIRCUIT



NOTES:

1. Linear dimensions are in inches [millimeters]. Dimensions in parenthesis are for reference only. Controlling dimensions are in inches. Dimensioning and tolerancing per ASME Y14.5M.
2. This drawing is subject to change without notice.
3. This dimension does not include mold flash, protrusions, or gate burrs. Mold flash, protrusions, or gate burrs shall not exceed .006 [0.15] per side.
4. This dimension does not include interlead flash.
5. Reference JEDEC registration MS-012, variation AA.

# EXAMPLE BOARD LAYOUT

D0008A

SOIC - 1.75 mm max height

SMALL OUTLINE INTEGRATED CIRCUIT



LAND PATTERN EXAMPLE  
 EXPOSED METAL SHOWN  
 SCALE:8X



SOLDER MASK DETAILS

4214825/C 02/2019

NOTES: (continued)

- 6. Publication IPC-7351 may have alternate designs.
- 7. Solder mask tolerances between and around signal pads can vary based on board fabrication site.

# EXAMPLE STENCIL DESIGN

D0008A

SOIC - 1.75 mm max height

SMALL OUTLINE INTEGRATED CIRCUIT



SOLDER PASTE EXAMPLE  
BASED ON .005 INCH [0.125 MM] THICK STENCIL  
SCALE:8X

4214825/C 02/2019

NOTES: (continued)

8. Laser cutting apertures with trapezoidal walls and rounded corners may offer better paste release. IPC-7525 may have alternate design recommendations.
9. Board assembly site may have different recommendations for stencil design.

## IMPORTANT NOTICE AND DISCLAIMER

TI PROVIDES TECHNICAL AND RELIABILITY DATA (INCLUDING DATA SHEETS), DESIGN RESOURCES (INCLUDING REFERENCE DESIGNS), APPLICATION OR OTHER DESIGN ADVICE, WEB TOOLS, SAFETY INFORMATION, AND OTHER RESOURCES "AS IS" AND WITH ALL FAULTS, AND DISCLAIMS ALL WARRANTIES, EXPRESS AND IMPLIED, INCLUDING WITHOUT LIMITATION ANY IMPLIED WARRANTIES OF MERCHANTABILITY, FITNESS FOR A PARTICULAR PURPOSE OR NON-INFRINGEMENT OF THIRD PARTY INTELLECTUAL PROPERTY RIGHTS.

These resources are intended for skilled developers designing with TI products. You are solely responsible for (1) selecting the appropriate TI products for your application, (2) designing, validating and testing your application, and (3) ensuring your application meets applicable standards, and any other safety, security, regulatory or other requirements.

These resources are subject to change without notice. TI grants you permission to use these resources only for development of an application that uses the TI products described in the resource. Other reproduction and display of these resources is prohibited. No license is granted to any other TI intellectual property right or to any third party intellectual property right. TI disclaims responsibility for, and you will fully indemnify TI and its representatives against, any claims, damages, costs, losses, and liabilities arising out of your use of these resources.

TI's products are provided subject to [TI's Terms of Sale](#) or other applicable terms available either on [ti.com](https://www.ti.com) or provided in conjunction with such TI products. TI's provision of these resources does not expand or otherwise alter TI's applicable warranties or warranty disclaimers for TI products.

TI objects to and rejects any additional or different terms you may have proposed.

Mailing Address: Texas Instruments, Post Office Box 655303, Dallas, Texas 75265  
Copyright © 2024, Texas Instruments Incorporated