

Powering Tiva™ C Series Microcontrollers Using the High Efficiency DCS-Control™ Topology

Ashish Ahuja and Chris Glaser

ABSTRACT

The new Tiva C Series ARM® Cortex™-M4 family of versatile microcontrollers provides prolific connectivity peripherals, such as the industry's first integrated Ethernet MAC and PHY, advanced analog integration and hardware floating-point performance. The TM4C123x and TM4C129x family of microcontrollers can be configured to operate in different power modes such as hibernation mode, deep-sleep mode, sleep mode and run mode to optimize the balance between power consumption and performance to suit a wide range of end-applications. High-efficiency at both very low power consumption (deep-sleep mode and hibernation mode) and high performance (run mode at full system clock speed) has become indispensable for modern applications. Moreover, in handheld, battery-operated applications that simultaneously connect, communicate and control, high-efficiency power management is imperative to extend the battery stand-by time. This application report presents an ultra-low I_Q (4.8 μ A) power supply solution for Tiva C Series devices using the TPS62177, a high efficiency synchronous step-down DC-DC converter, based on the DCS-Control (Direct Control with Seamless Transition into Power Save Mode) topology. The TPS62177 interfaces seamlessly with Tiva C Series devices' low power modes, meeting the power requirements of embedded systems driven from 2- to 6-cell lithium batteries, as well as USB ports and higher voltage AC adaptors.

Contents

1	Introduction	1
2	Tiva C Series MCUs Power Requirements	2
3	TPS62177 Power Supply Solution	2
4	Conclusion	6
5	References	6

1 Introduction

The current consumed by Tiva C Series devices can vary from a few micro amperes to tens of milli-amperes, depending on several factors in the end-application such as the mode of operation, system clock frequency, number of peripherals being clocked at a given time, drive strength of GPIOs and number of GPIOs being used to drive loads. The TPS62177 provides a single-chip switch mode power supply solution that dynamically enters Power Save Mode for light loads to maintain high efficiency across the entire load current range of Tiva C Series devices. This power convertor also features a SLEEP mode (not to be confused with the Sleep mode of the microcontroller) and Shutdown mode to dramatically reduce the quiescent current.

Tiva, DCS-Control are trademarks of Texas Instruments.
Cortex is a trademark of ARM Limited.
ARM is a registered trademark of ARM Limited.
All other trademarks are the property of their respective owners.

2 Tiva C Series MCUs Power Requirements

The Tiva C Series MCUs have very straightforward power supply requirements. A single channel, 3.3-V power supply can power both the digital (V_{DD}) and analog (V_{DDA}) power rails of the microcontroller. For proper device operation, the power supply voltage must remain between the minimum (3.15 V) and maximum (3.63 V) voltages specified in the datasheet at all times. The current required by this single supply is application dependent but is usually no more than 50 mA. For current consumption across the entire operating range at different clock frequencies and temperatures, see the device-specific microcontroller data sheet.

Additionally, the Tiva C Series microcontrollers may be powered with two separate power supplies to operate in hibernation mode without VDD3ON mode. In hibernation mode, the core, clocking system and all peripherals (except the hibernation module) are powered down, thereby dramatically reducing the overall power consumption. The hibernation module, which features an integrated 32-bit real-time clock (RTC), can remain powered on using an auxiliary power source or main power rail to detect a variety of system wake-up events. Typically, a coin cell battery is used as an auxiliary power supply and is connected to the VBAT pin of the microcontroller through an RC filter.

3 TPS62177 Power Supply Solution

The TPS62177 synchronous switch mode power converter is based on the DCS-Control™ topology, an advanced regulation topology that combines the advantages of hysteretic, voltage-mode and current-mode control including an AC loop directly associated to the output voltage. Operating from a 4.75-V to 28-V input voltage and capable of sourcing 500 mA of current at 3.3 V, the TPS62177 provides the required output power for most systems in which the Tiva C Series devices are used. The DCS-Control topology supports pulse width modulation (PWM) mode for medium- and heavy-load conditions and a power-save mode at light loads. The TPS62177 converter seamlessly enters power save mode when the load current is scaled down, increasing efficiency in light load operation.

The TPS62177 also contains a SLEEP input pin that can be connected to the \overline{HIB} pin of the Tiva C Series microcontroller to dynamically increase the efficiency of the power supply when the microcontroller is in hibernation mode. Furthermore, the output voltage from the TPS62177 provides an acceptable start up and shutdown behavior for the Tiva C Series microcontrollers. Figure 1 shows the TPS62177 power supply solution for Tiva C Series devices.

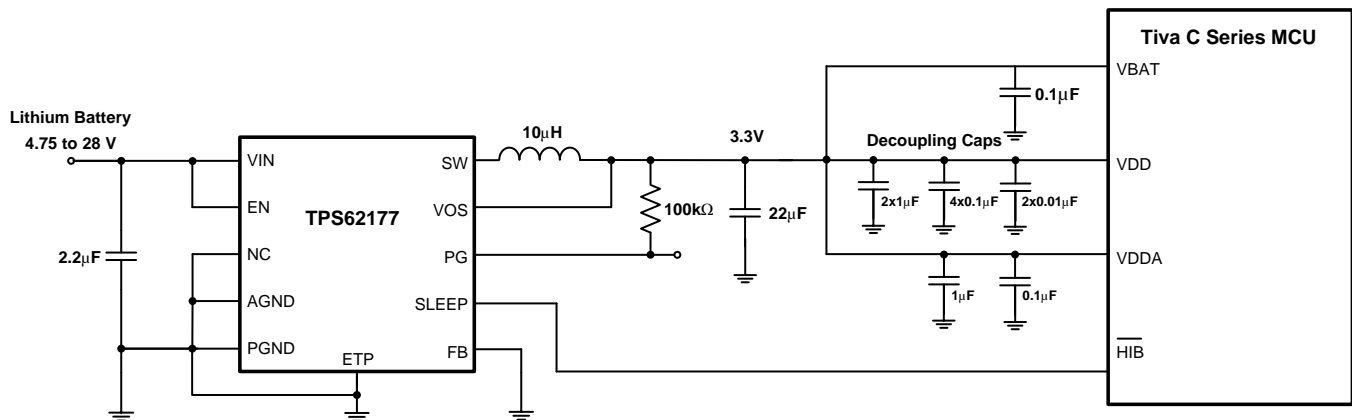

Figure 1. TPS62177 Power Supply Solution for the TM4C123x MCU

3.1 TPS62177 Efficiency

System standby and run times are very important in handheld systems such as notebooks and tablets that are powered by rechargeable batteries. In such systems, typically 2-cell lithium ion batteries are used and the battery pack voltage is around 7.5 V. The current drawn from the battery when these systems are in the standby mode determines system standby time. In addition, when these systems are in full operating mode, the battery current drawn influences system run time.

In the systems referenced above, the TPS62177 provides efficiency in excess of 80% at a 7.5-V input voltage when a Tiva C Series device consumes more than 1 mA. The TPS62177's SLEEP mode can be activated by directly connecting the $\overline{\text{HIB}}$ pin of Tiva C Series device to the SLEEP pin of the TPS62177, as shown in Figure 1, while the microcontroller is configured to operate in hibernation mode. SLEEP mode increases the efficiency at load current less than ~1 mA. For example, at 10- μA load current, the efficiency in SLEEP mode is about 35% compared to about 15% in non-SLEEP power save mode reducing the current drawn from the battery by 55% from 29 μA to 13 μA . Figure 2 shows the efficiency curve of the TPS62177 at a 7.5-V input voltage, while Table 1 lists this same efficiency at the typical operating points of the TM4C123x MCU. The MCU current in the table refers to the combined I_{DD} and I_{DDA} currents, while the battery current refers to the current into the TPS62177 power supply.

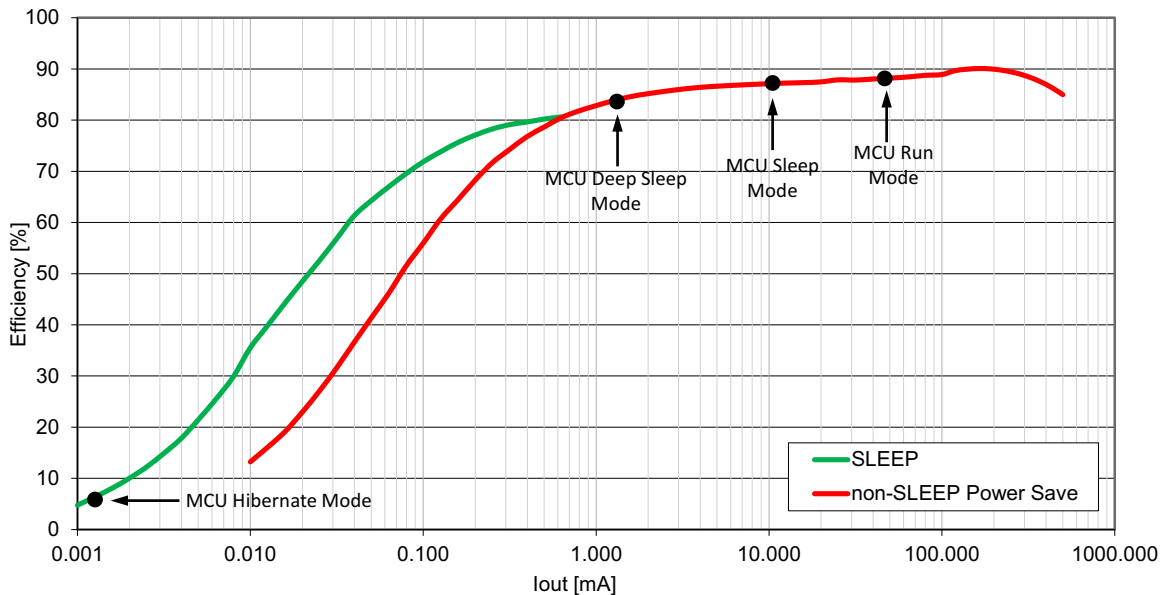

Figure 2. Efficiency of the TPS62177 at a 7.5-V Input Voltage

Table 1. TM4C123x MCU Operating Points, Efficiency, and Battery Current at 25°C ⁽¹⁾

Mode	Run	Sleep	Deep Sleep	Hibernate
MCU Current Consumption $I_{\text{DD}} + I_{\text{DDA}}$	47.81 mA (80-MHz system clock from Main Oscillator and PLL)	9.67 mA (16-MHz system clock from Precision Internal Oscillator)	1.35 mA (30-kHz system clock from Low Frequency Internal Oscillator)	1.38 μA (external wake, RTC disabled)
TPS62177 Mode	Power Save	Power Save	Power Save	SLEEP
Efficiency (%)	88	87	84	6.4 ⁽²⁾
Battery Current at 7.5-V Input Voltage	23.9 mA	4.89 mA	0.71 mA	9.5 μA

⁽¹⁾ The parametric values in this table are preliminary. For the most up-to-date electrical characteristics, see the device-specific data sheet.

⁽²⁾ If the TPS62177's SLEEP mode were not used, the battery current consumption in Hibernate Mode would be 28.7 μA --an increase of 302%.

3.2 TPS62177 SLEEP Mode Entry and Exit

The efficiency in hibernation mode can be greatly increased by connecting the $\overline{\text{HIB}}$ output of the Tiva C Series device to the SLEEP input of the TPS62177. This connection is not required for either device, but doing so prolongs the system standby time in battery powered applications. The TPS62177's efficiency in SLEEP mode is improved by both a reduction of its quiescent current as well as its switching frequency, which is shown by the inductor current in Figure 3 and Figure 4.

For proper operation of the microcontroller, V_{DD} must always be within the operating voltage range as specified in the device-specific data sheet. Some power supplies may not offer the required output voltage regulation during a change in load, resulting in a voltage overshoot or undershoot. Figure 3 shows the TM4C123x MCU exiting hibernation mode, while Figure 4 shows the TM4C123x MCU entering its hibernation mode (and entering the TPS62177's SLEEP mode). In both scenarios, the 3.3-V supply voltage stays within the operating voltage range as specified in the device-specific microcontroller's data sheet.

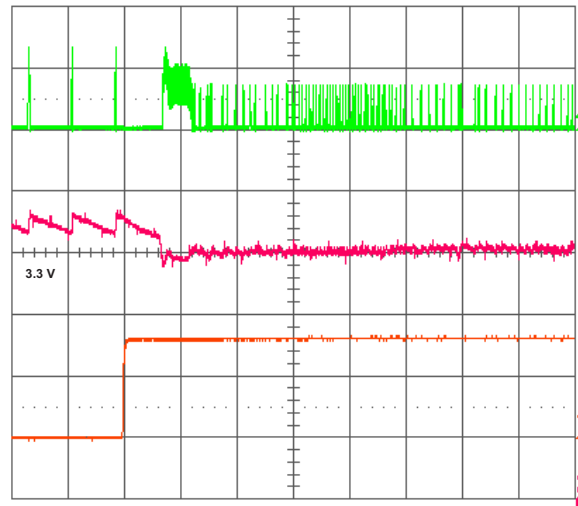

Figure 3. TM4C123x MCU Exiting Hibernate Mode

Timescale	Channel 1	Channel 2	Channel 4
50 μ sec/div	HIB (2V/div)	V_{DD} (50mV/div)	Inductor Current (200mA/div)

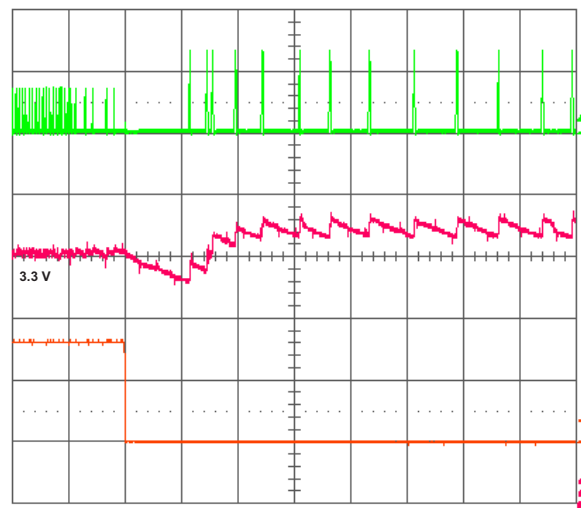

Figure 4. TM4C123x MCU Entering Hibernate Mode

Timescale	Channel 1	Channel 2	Channel 4
50 μ sec/div	HIB (2V/div)	V_{DD} (50mV/div)	Inductor Current (200mA/div)

3.3 TPS62177 Startup and Shutdown Behavior

The power supply must start up and shutdown properly when powered through the system's source impedance and limit the output voltage overshoot within the limits specified in the device-specific microcontroller's data sheet.

Figure 5 and Figure 6 show the start up and shutdown behavior, respectively, of the circuit in Figure 1 when powered from a typical USB 5-V input voltage. The 3.3-V power supply voltage does not overshoot on start up and is monotonic during both start up and shutdown.

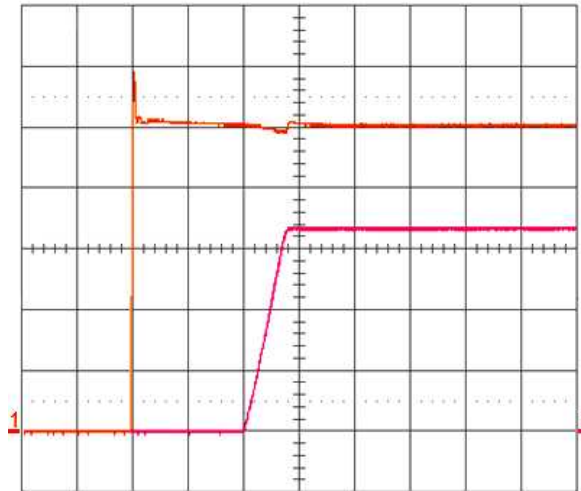

Figure 5. TM4C123x MCU Circuit Start Up From 5 V

Timescale	Channel 1	Channel 2
500 μsec/div	VIN (1V/div)	V _{DD} (1V/div)

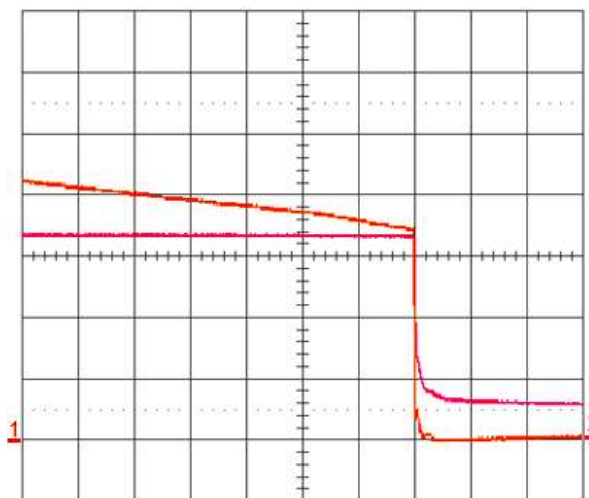

Figure 6. TM4C123x MCU Circuit Shutdown From 5 V

Timescale	Channel 1	Channel 2
1 msec/div	VIN (1V/div)	V _{DD} (1V/div)

All systems have some impedance from the power source to the microcontroller power supply. This source impedance can come from the impedances of any combination of power supply cables, batteries, sense resistors or fuses, power switches, connectors, and so forth. This source impedance may cause difficulty during the start up of some power supplies. Figure 7 shows the Figure 1 circuit starting with a very high 10-Ω source impedance. Even with this high source impedance, the output voltage comes up monotonically and without overshoot. Though the input voltage drops during start up due to inrush currents during turn on, this drop is not high enough to affect the smooth turn on of the TPS62177.

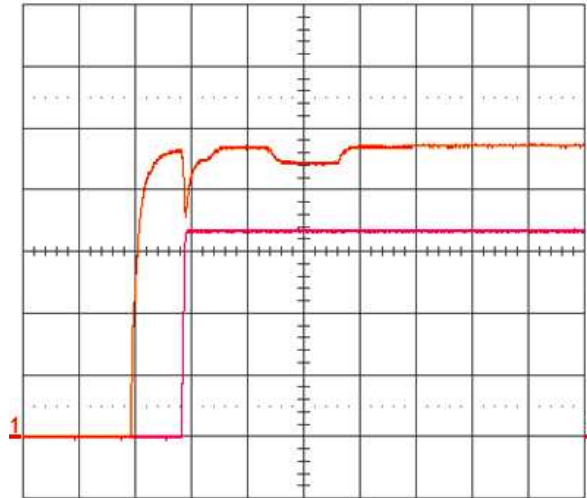

Figure 7. TM4C123x MCU Circuit Start Up From 5 V With 10-Ω Source Impedance

Timescale	Channel 1	Channel 2
5 msec/div	VIN (1V/div)	V _{DD} (1V/div)

4 Conclusion

Tiva C Series microcontrollers provide a high-performance embedded processing solution for industrial and home automation applications that simultaneously connect, communicate and control. When combined with the TPS62177 DCS-Control power supply, numerous end-equipments can achieve longer battery run time due to the complementarity of each device's power saving modes. This simple and easy to use combination provides a high-performance, high-efficiency system solution for the latest handheld battery-powered devices.

5 References

- TM4C123x MCU Data Sheet (http://www.ti.com/lscds/ti/microcontroller/tiva_arm_cortex/c_series/tech_docs.page)
- TM4C123x MCU Errata (http://www.ti.com/lscds/ti/microcontroller/tiva_arm_cortex/c_series/tech_docs.page)
- TPS62175, TPS62177 28V, 0.5A Step-Down Converter with Sleep Mode Data Sheet ([SLVSB35](#))
- DCS-Control Landing Page: www.ti.com/dcs-control

IMPORTANT NOTICE

Texas Instruments Incorporated and its subsidiaries (TI) reserve the right to make corrections, enhancements, improvements and other changes to its semiconductor products and services per JESD46, latest issue, and to discontinue any product or service per JESD48, latest issue. Buyers should obtain the latest relevant information before placing orders and should verify that such information is current and complete. All semiconductor products (also referred to herein as "components") are sold subject to TI's terms and conditions of sale supplied at the time of order acknowledgment.

TI warrants performance of its components to the specifications applicable at the time of sale, in accordance with the warranty in TI's terms and conditions of sale of semiconductor products. Testing and other quality control techniques are used to the extent TI deems necessary to support this warranty. Except where mandated by applicable law, testing of all parameters of each component is not necessarily performed.

TI assumes no liability for applications assistance or the design of Buyers' products. Buyers are responsible for their products and applications using TI components. To minimize the risks associated with Buyers' products and applications, Buyers should provide adequate design and operating safeguards.

TI does not warrant or represent that any license, either express or implied, is granted under any patent right, copyright, mask work right, or other intellectual property right relating to any combination, machine, or process in which TI components or services are used. Information published by TI regarding third-party products or services does not constitute a license to use such products or services or a warranty or endorsement thereof. Use of such information may require a license from a third party under the patents or other intellectual property of the third party, or a license from TI under the patents or other intellectual property of TI.

Reproduction of significant portions of TI information in TI data books or data sheets is permissible only if reproduction is without alteration and is accompanied by all associated warranties, conditions, limitations, and notices. TI is not responsible or liable for such altered documentation. Information of third parties may be subject to additional restrictions.

Resale of TI components or services with statements different from or beyond the parameters stated by TI for that component or service voids all express and any implied warranties for the associated TI component or service and is an unfair and deceptive business practice. TI is not responsible or liable for any such statements.

Buyer acknowledges and agrees that it is solely responsible for compliance with all legal, regulatory and safety-related requirements concerning its products, and any use of TI components in its applications, notwithstanding any applications-related information or support that may be provided by TI. Buyer represents and agrees that it has all the necessary expertise to create and implement safeguards which anticipate dangerous consequences of failures, monitor failures and their consequences, lessen the likelihood of failures that might cause harm and take appropriate remedial actions. Buyer will fully indemnify TI and its representatives against any damages arising out of the use of any TI components in safety-critical applications.

In some cases, TI components may be promoted specifically to facilitate safety-related applications. With such components, TI's goal is to help enable customers to design and create their own end-product solutions that meet applicable functional safety standards and requirements. Nonetheless, such components are subject to these terms.

No TI components are authorized for use in FDA Class III (or similar life-critical medical equipment) unless authorized officers of the parties have executed a special agreement specifically governing such use.

Only those TI components which TI has specifically designated as military grade or "enhanced plastic" are designed and intended for use in military/aerospace applications or environments. Buyer acknowledges and agrees that any military or aerospace use of TI components which have **not** been so designated is solely at the Buyer's risk, and that Buyer is solely responsible for compliance with all legal and regulatory requirements in connection with such use.

TI has specifically designated certain components as meeting ISO/TS16949 requirements, mainly for automotive use. In any case of use of non-designated products, TI will not be responsible for any failure to meet ISO/TS16949.

Products

Audio	www.ti.com/audio
Amplifiers	amplifier.ti.com
Data Converters	dataconverter.ti.com
DLP® Products	www.dlp.com
DSP	dsp.ti.com
Clocks and Timers	www.ti.com/clocks
Interface	interface.ti.com
Logic	logic.ti.com
Power Mgmt	power.ti.com
Microcontrollers	microcontroller.ti.com
RFID	www.ti-rfid.com
OMAP Applications Processors	www.ti.com/omap
Wireless Connectivity	www.ti.com/wirelessconnectivity

Applications

Automotive and Transportation	www.ti.com/automotive
Communications and Telecom	www.ti.com/communications
Computers and Peripherals	www.ti.com/computers
Consumer Electronics	www.ti.com/consumer-apps
Energy and Lighting	www.ti.com/energy
Industrial	www.ti.com/industrial
Medical	www.ti.com/medical
Security	www.ti.com/security
Space, Avionics and Defense	www.ti.com/space-avionics-defense
Video and Imaging	www.ti.com/video

TI E2E Community

e2e.ti.com